

TK-860G/862G

SERVICE MANUAL

SUPPLEMENT

This service manual mainly covers TK-860G K2, M2 and TK-862G K2.
If information you require is missing from this service manual.
Please refer to the B51-8498-10 service manual.

TK-860G (K)



TK-862G (K)

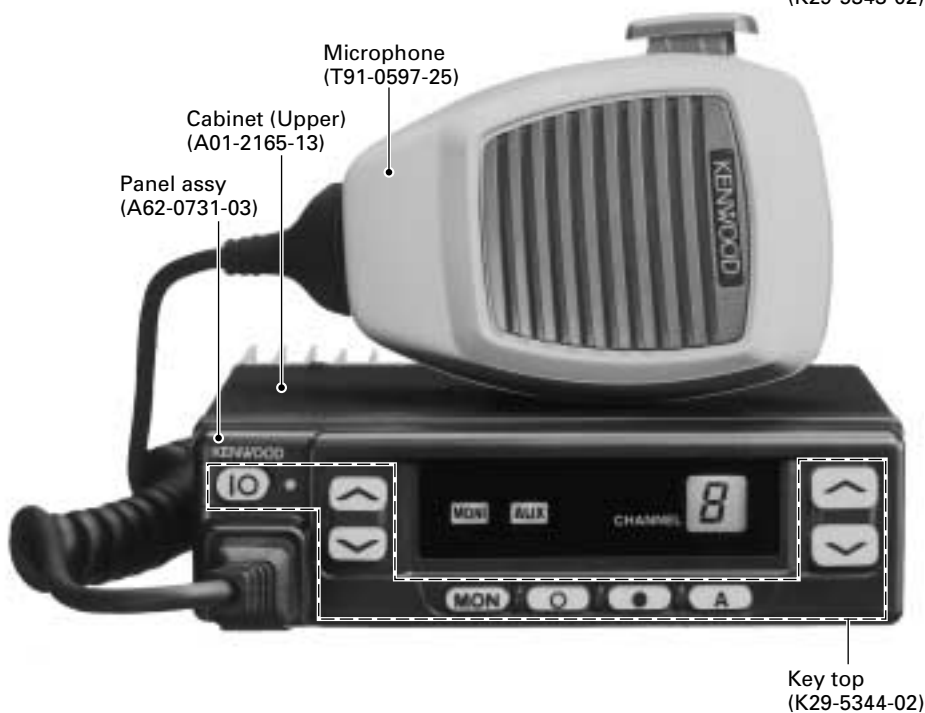

TK-860G/862G

CONTENTS

OPERATING FEATURES	3
REALIGNMENT	4
INSTALLATION	5
PARTS LIST	8
ADJUSTMENT	17
PC BOARD VIEWS	
DISPLAY UNIT (X54-3270-10) : TK-860G	26
DISPLAY UNIT (X54-3280-10) : TK-862G	27
PLL/VCO (X58-4670-XX)	28
TX-RX UNIT (X57-5960-XX) (A/2)	29
TX-RX UNIT (X57-5960-XX) (B/2)	35
SCHEMATIC DIAGRAM	39
SPECIFICATIONS	47

OPERATING FEATURES

Emergency

Pressing this key for longer than 1 second causes the transceiver to enter the emergency mode. The transceiver jumps to the programmed "Emergency the group and channel" and transmits for 25 seconds.

The transceiver disables mic mute while transmitting. After finishing transmission, the transceiver receives for 5 seconds. The transceiver mutes the speaker while receiving. Following the above sequence, the transceiver continues to transmit and receive.

Radio Password (TK-860G only)

When the password is set in the transceiver, user can not use the transceiver unless enter the correct password.

This code can be up to 6 digits from 0 to 9 and input with the key, and "SCN" key.

■ Emergency mode system chart (TK-860G)

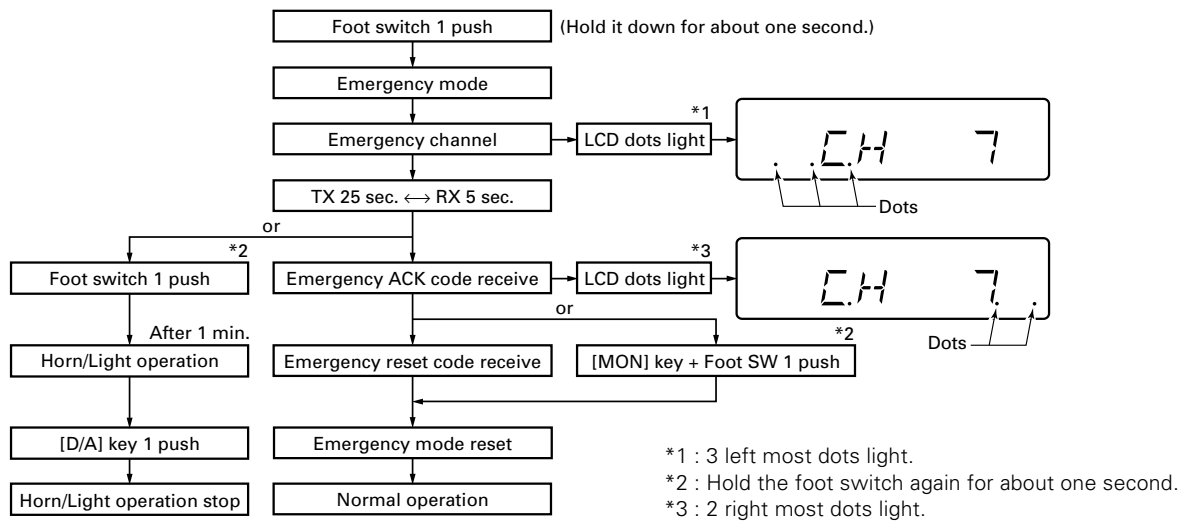

■ Emergency mode system chart (TK-862G)

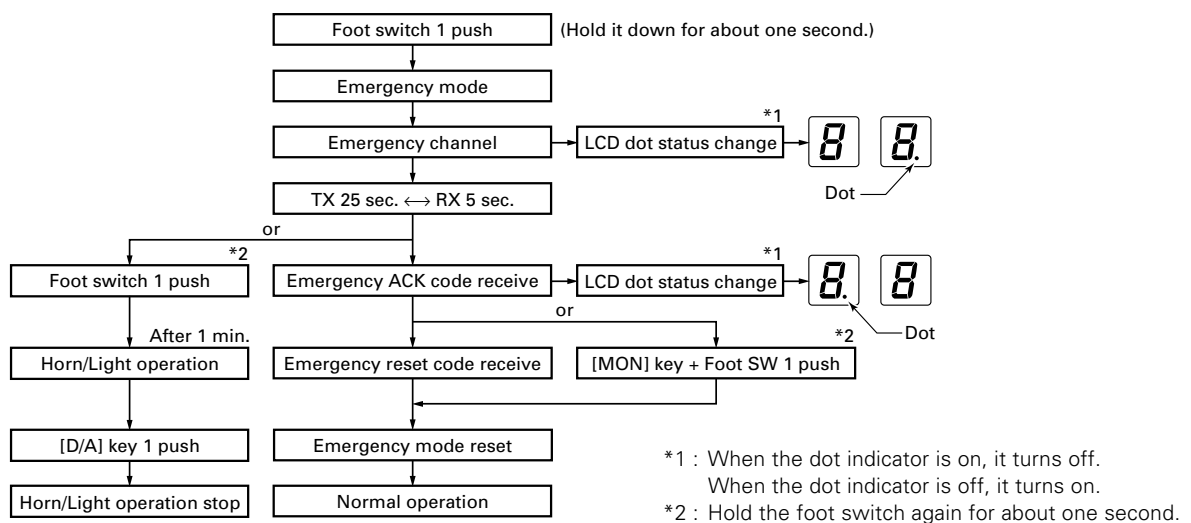

TK-860G/862G

REALIGNMENT

Clone Mode

Programming data can be transferred from one radio to another by connecting them via their modular microphone jacks. The operation is as follows (the transmit radio is the master and the receive radio is the slave).

1. Turn the master TK-860G power ON with the [▼] key held down. If the password is set to the TK-860G, the TK-860G displays "CLN LOCK". If the password is not set, the TK-860G displays "CLONE".
2. When "CLN LOCK" is displayed, only the [CH▲/▼] key and [SCN], and [0] to [9] keys can be accepted. When you enter the correct password, and "CLONE" is displayed, the TK-860G can be used as the cloning master. The following describes how to enter the password.
3. How to enter the password with the microphone keypad; If you press a key while "CLN LOCK" is displayed, the number that was pressed is displayed on the TK-860G. Each press of the key shifts the display in order to the left. When you enter the password and press the [SCN] key, "CLONE" is displayed if the entered password is correct. If the password is incorrect, "CLN LOCK" is redisplayed.
How to enter the password with the [CH▲/▼] key; If the [CH▲/▼] key is pressed while "CLN LOCK" is displayed, numbers (0 to 9) are displayed flashing. When you press the [SCN] key, the correctly selected number is determined, and the display shifts to the left. If you press the [SCN] key after entering the password in this procedure, "CLONE" is displayed if the entered password is correct. If the password is incorrect, "CLN LOCK" is redisplayed.
4. Power on the slave TK-860G/862G.
5. Connect the cloning cable (No. E30-3382-05) to the modular microphone jacks on the master and slave.
6. Press the [SCN] key on the master while the master displays "CLONE". The data of the master is sent to the slave. While the slave is receiving the data, "-PC-" is displayed. When cloning of data is completed, the master displays "END", and the slave automatically operates in the User mode. The slave can then be operated by the same program as the master.
7. The other slave can be continuously cloned. When the [SCN] key on the master is pressed while the master displays "END", the master displays "CLONE". Carry out the operation in step 4 to 6.

Note :

You can clone the programmed data between the transceiver frequency version must be same.

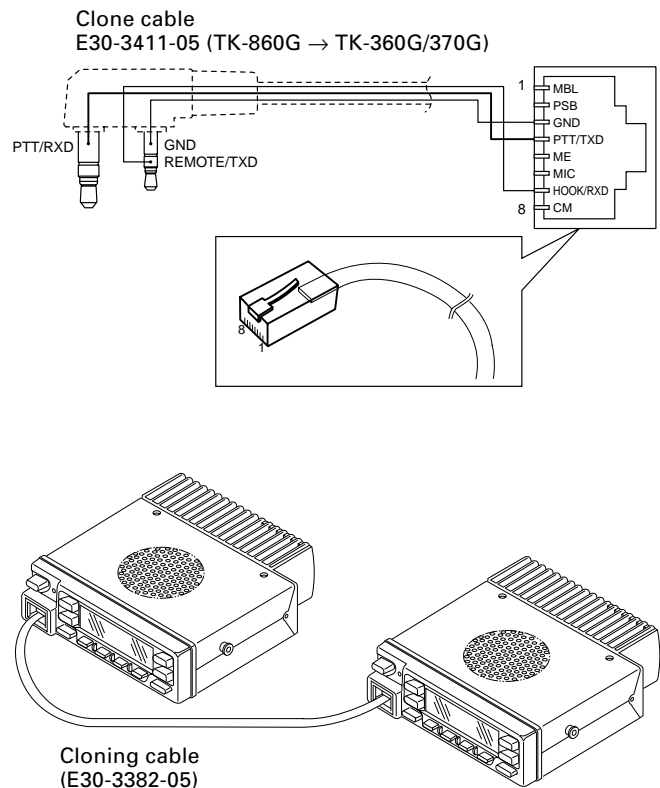

Fig. 1

INSTALLATION

Ignition Sense Cable (KCT-18 : Option)

The KCT-18 is an optional cable for enabling the ignition function. The ignition function lets you turn the power to the transceiver on and off with the car ignition key.

If you use the Horn Alert function or the Manual Relay function, you can turn the function off while driving with the ignition key.

■ Connecting the KCT-18 to the Transceiver

1. Install the KCT-19 in the transceiver.
2. Insert the KCT-18 lead terminal (❷) into pin 3 of the square plug (❶) supplied with the KCT-19, then insert the square plug into the KCT-19 connector (❸).

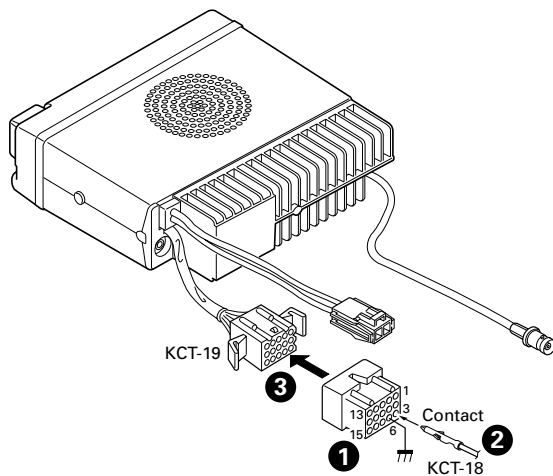

Fig. 1

■ Modifying the Transceiver

Modify the transceiver as follows to turn the power or the Horn Alert or Manual Relay function on and off with the ignition key.

1. Remove the lower half of the transceiver case.
2. Set jumper resistors (0Ω) R134 and R135 of the TX-RX unit (A/2) as shown in Table 1.

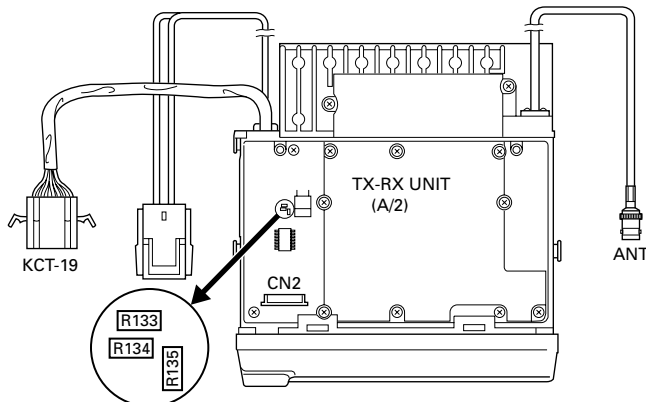

Fig. 2

Operation when KCT-18 is connected	R134	R135
	Enable	Enable
Power on/off and Horn Alert or AUX-A on/off	Disable	Enable
Horn Alert or AUX-A on/off	Enable	Disable
	Disable	Disable

← **KCT-18 cannot be connected**

← **Power cannot be turned on**

Table 1 R134 and R135 setup chart

PA/HA Unit (KAP-1 : Option)

■ Installing the KAP-1 in the Transceiver

The Horn Alert (max. 2A drive) and Public Address functions are enabled by inserting the KAP-1 W1 (3P; white/black/red) into CN3 on the TX-RX unit, inserting W2 (3P; green) into CN7 on the TX-RX unit, and connecting the KCT-19 (option) to CN2 and CN3 of the KAP-1.

• Installation procedure

1. Open the upper case of the transceiver.
2. Insert the two cables (❶) with connectors from the KAP-1 switch unit into the connectors on the transceiver.
3. Secure the switch unit board to the chassis with a screw (❷). The notch (❸) in the board must be placed at the front left side.
4. Attach the cushion on the top of the KAP-1 switch unit.

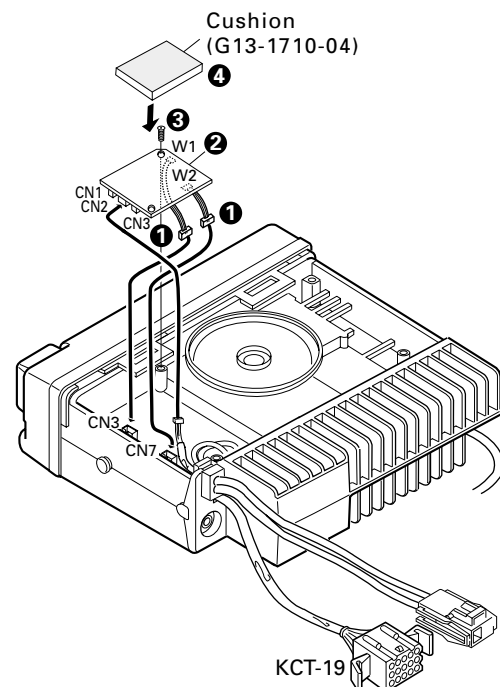

Fig. 3

INSTALLATION

■ Modifying the Transceiver

• Horn alert

The signal from pin 4 of IC9 on the TX-RX unit turns Q5 and Q1 on and off and drives KAP-1 HA relay K2 to drive the horn with a maximum of 2A.

The default output is HR1. The relay open output can be obtained between HR1 and HR2 by removing R1 in the KAP-1.

	R1	Output form
HR1 (Default)	Enable	
HR2	Disable	

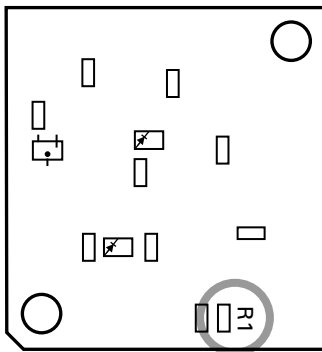

Fig. 4 KAP-1 foil side view

• Public address

The signal from pin 13 of IC9 on the TX-RX unit drives PA relay K1 in the KAP-1 and switches the audio power amplifier output between the external PA system (through KCT-19) and internal and external speakers.

To use the PA function, R153 on the TX-RX unit must be removed.

	R153
Use the PA function	Disable
Do not use the PA function	Enable

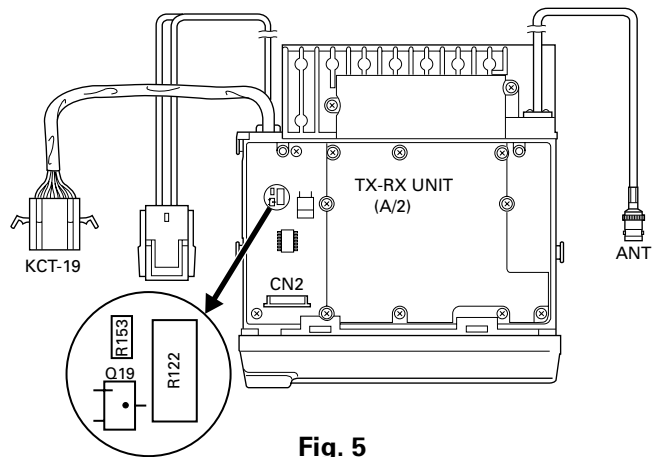

Fig. 5

■ Others

If the PA and HR2 are not necessary and the speaker output is output to an external unit through the KCT-19, connect the KCT-19 C connector to CN8 on the TX-RX unit.

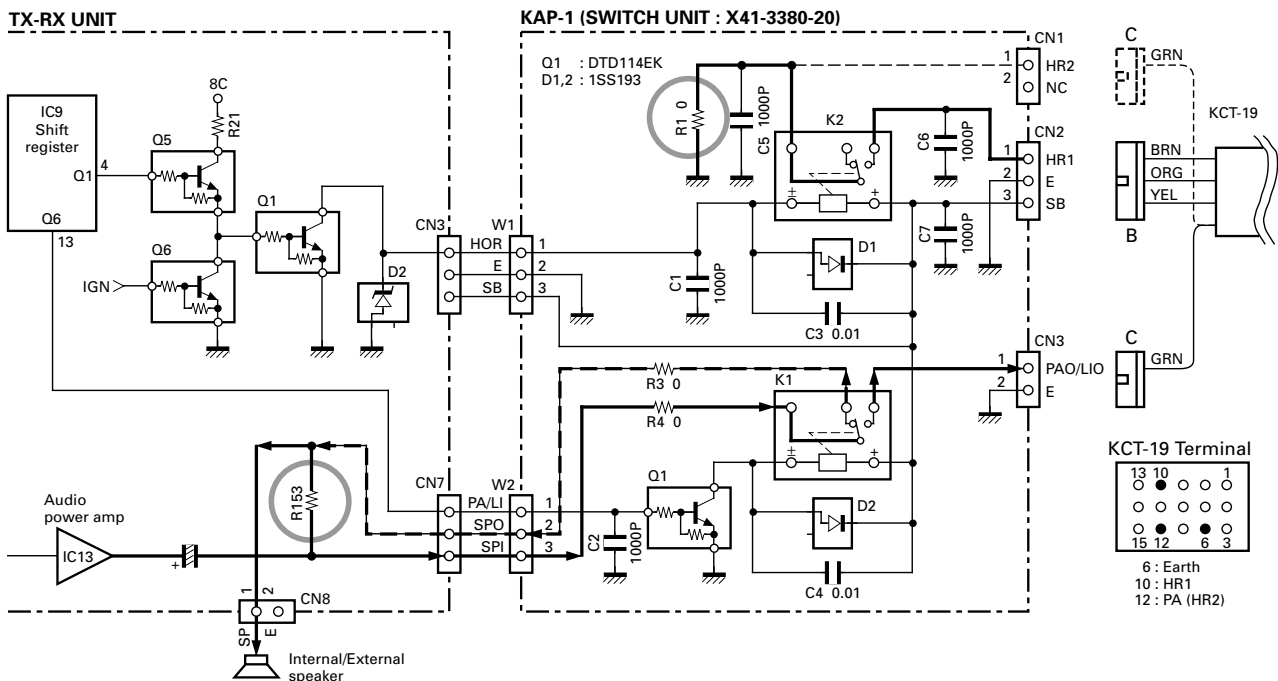

Fig. 6

INSTALLATION

Emergency Mode

■ Transceiver Modification Procedure

• Install the foot switch

Install the foot switch through the KCT-19 and KCT-18. When the switch is treaded on, the radio enters the emergency mode.

• Change the power switch circuit

TX-RX unit (B/2) : Control section
 \$R705 : Attach (R92-1252-05, 0Ω)

TX-RX unit (A/2) : RF section
 R142 : Remove (RK73GB1J473J, 47kΩ)

Once the transceiver is modified, it cannot be turned on and off with the power switch. The power switch turns the LCD backlight and display on and off. (The power is switched on and off by IGNITION SENSE.)

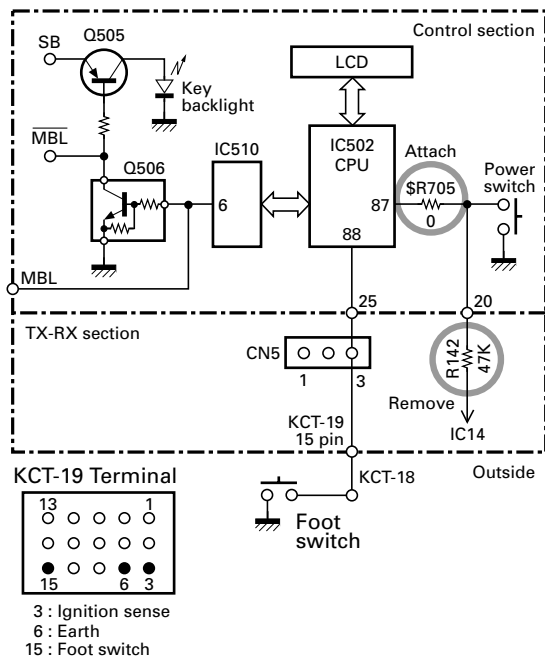

Fig. 7

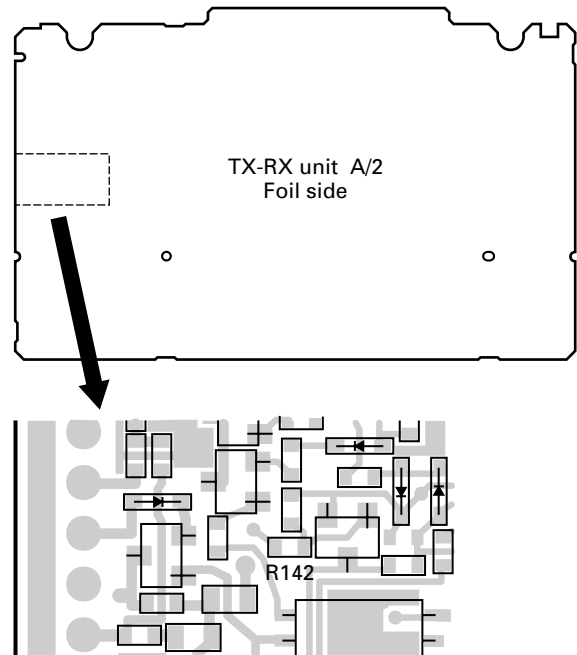
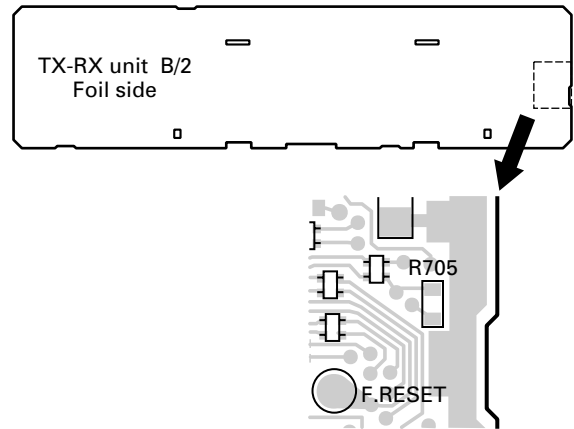

Fig. 8

TK-860G/862G

PARTS LIST

*New Parts. ⚠ indicates safety critical components.

Parts without **Parts No.** are not supplied.

Les articles non mentionnés dans le **Parts No.** ne sont pas fournis.

Teile ohne **Parts No.** werden nicht geliefert.

L : Scandinavia

K : USA

P : Canada

Y : PX (Far East, Hawaii)

T : England

E : Europe

Y : AAFES (Europe)

X : Australia

M : Other Areas

TK-860G/862G

DISPLAY UNIT (X54-3270-10) : TK-860G, DISPLAY UNIT (X54-3280-10) : TK-862G

Ref. No.	Address	New parts	Parts No.	Description	Destination
TK-860G/862G					
1	1B,1F		A01-2165-13	CABINET UPPER	
2	2A,2D		A01-2166-13	CABINET LOWER	
3	2A		A62-0642-03	PANEL ASSY	860
3	2D		A62-0731-03	PANEL ASSY	862
5	1G		B09-0235-05	CAP	
6	2B		B11-1226-03	ILLUMINATION GUIDE	860
6	2E		B11-1230-03	ILLUMINATION GUIDE	862
7	2A		B38-0824-05	LCD	860
7	2E		B38-0825-05	LCD	862
8	2G		B62-1257-20	INSTRUCTION MANUAL	M,M2
8	2G		B62-1258-10	INSTRUCTION MANUAL	K,K2,K3
9	1C		B72-1692-04	MODEL NAME PLATE	860K
9	1C		B72-1693-04	MODEL NAME PLATE	860M
9	1F		B72-1695-04	MODEL NAME PLATE	862K
9	1C		B72-1743-04	MODEL NAME PLATE	860K3
9	1C		B72-1808-04	MODEL NAME PLATE	860K2
9	1C		B72-1809-04	MODEL NAME PLATE	860M2
9	1F		B72-1810-04	MODEL NAME PLATE	862K2
11	2B		E29-1179-04	INTER CONNECTOR	860
11	2E		E29-1183-04	INTER CONNECTOR	862
12	1C,1F		E30-2145-15	ANTENNA CABLE	
13	1G		E30-3339-05	DC CORD ACC	
14	1C,1F		E30-3340-05	DC CORD RADIO	
-	-		E30-3404-05	EXTENSION CABLE	
16	1C,1F		E37-0790-25	LEAD WIRE WITH CONNECTOR (SP)	
17	2B,2E		E37-0815-05	FLAT CABLE	
18	2B,2E		F12-0435-04	CONDUCTIVE SHEET	
19	1G		F51-0016-05	FUSE (6*30) 10A	
21	1C,1F		G02-0791-04	FLAT SPRING AF,APC	
22	1B,1E		G10-1221-04	FIBROUS SHEET SIDE	
23	1B,1E		G10-1222-14	FIBROUS SHEET UP,DOWN	
24	1A,1D		G10-1223-14	FIBROUS SHEET SHIELD	
25	1C,1F		G13-1468-04	CUSHION DC CORD	
26	1B,1E		G13-1759-04	CUSHION SP	
27	2C,2F		G53-0796-04	PACKING PHONE JACK	
28	2E		G53-0889-04	PACKING DISPLAY UNIT	862
30	3G		H10-6618-12	POLYSTYRENE FOAMED FIXTURE (F)	
31	2H		H10-6619-12	POLYSTYRENE FOAMED FIXTURE (R)	
32	1G		H12-1391-03	INNER PACKING CASE	
33	1H,2H		H25-0720-04	PROTECTION BAG (200X350)	
34	3H		H52-1519-02	ITEM CARTON CASE	
36	2G		J19-1584-05	HOLDER ACC	
37	2A,2D		J21-8382-03	HARDWARE FIXTURE	
38	1G		J29-0627-23	BRACKET	
40	2A		K29-5343-02	KEY TOP	860
40	2D		K29-5344-02	KEY TOP	862
A	2A,2D		N33-2606-45	OVAL HEAD MACHINE SCREW	
B	2C,2F		N67-3008-46	PAN HEAD SEMS SCREW W	
C	2B,2E		N87-2606-46	BRAZIER HEAD TAPTITE SCREW	
D	2B,2E		N87-2612-46	BRAZIER HEAD TAPTITE SCREW	
42	2G		N99-0395-05	SCREW SET	

Ref. No.	Address	New parts	Parts No.	Description	Destination
44	1B,1F		T07-0368-05	SPEAKER	
45	1G		T91-0597-25	MICROPHONE	K,K2,K3
DISPLAY UNIT (X54-3270-10) : TK-860G					
D802-805		*	B30-2220-05	LED (2P/YELLOW)	
C801-803			CC73GCH1H101J	CHIP C 100PF J	
C804			CK73GF1A105Z	CHIP C 1.0UF Z	
C805			CK73GB1H102K	CHIP C 1000PF K	
C806,807			CK73GB1H471K	CHIP C 470PF K	
CN801			E40-6020-05	PIN ASSY	
L801			L92-0138-05	FERRITE CHIP	
R801-803			RK73GB1J103J	CHIP R 10K J 1/16W	
R804			RK73GB1J473J	CHIP R 47K J 1/16W	
R805			RK73GB1J474J	CHIP R 470K J 1/16W	
R806			R92-1252-05	CHIP R 0 OHM	
R808			RK73GB1J392J	CHIP R 3.9K J 1/16W	
R809			RK73FB2A270J	CHIP R 27 J 1/10W	
D801			MA2S111	DIODE	
D808			HSB123	DIODE	
IC801			LC75823W	IC (LCD DRIVER)	
Q801			2SB1132(Q,R)	TRANSISTOR	
DISPLAY UNIT (X54-3280-10) : TK-862G					
D801			B30-2204-05	LED (RED/YELLOW)	
D803			B30-2220-05	LED (2P/YELLOW)	
D804			B30-2204-05	LED (RED/YELLOW)	
C801			CK73GB1H471K	CHIP C 470PF K	
C802-804			CC73GCH1H101J	CHIP C 100PF J	
C805			CK73GF1A105Z	CHIP C 1.0UF Z	
C806			CK73GB1H471K	CHIP C 470PF K	
C807			CK73GB1H102K	CHIP C 1000PF K	
C808			CK73GB1H471K	CHIP C 470PF K	
C812			CK73GB1H471K	CHIP C 470PF K	
CN801			E40-6020-05	PIN ASSY	
L801			L92-0138-05	FERRITE CHIP	
R801,802			RK73GB1J103J	CHIP R 10K J 1/16W	
R803			RK73FB2A123J	CHIP R 12K J 1/10W	
R804			RK73GB1J103J	CHIP R 10K J 1/16W	
R805			RK73FB2A332J	CHIP R 3.3K J 1/10W	
R806			RK73GB1J474J	CHIP R 470K J 1/16W	
R807			R92-1252-05	CHIP R 0 OHM	
R808			RK73GB1J393J	CHIP R 39K J 1/16W	
R809			RK73FB2A123J	CHIP R 12K J 1/10W	
R810			RK73FB2A332J	CHIP R 3.3K J 1/10W	
R812			RK73FB2A561J	CHIP R 560 J 1/10W	

PARTS LIST

DISPLAY UNIT (X54-3280-10) : TK-862G
TX-RX UNIT (X57-5960-XX)

Ref. No.	Address	New parts	Parts No.	Description	Desti-nation	Ref. No.	Address	New parts	Parts No.	Description	Desti-nation
R813-816			RK73GB1J473J	CHIP R 47K J 1/16W		C73			CC73GCH1H101J	CHIP C 100PF J	
D802			MA2S111	DIODE		C74,75			CK73GB1H471K	CHIP C 470PF K	
IC801			LC75833W	IC (LCD DRIVER)		C77			C92-0561-05	CHIP-ELE 22UF 16WV	K,K2,M
Q801-803			DTA114EKA	DIGITAL TRANSISTOR		C77			C92-0561-05	CHIP-ELE 22UF 16WV	M2
Q804			KRA225S	DIGITAL TRANSISTOR		C78			CK73GB1H102K	CHIP C 1000PF K	
Q805			DTA114EKA	DIGITAL TRANSISTOR		C79,80			CK73GB1H221K	CHIP C 220PF K	
Q806-809			2SK1824	FET		C81			CK73GB1H471K	CHIP C 470PF K	
TX-RX UNIT (X57-5960-XX)						C82			C92-0507-05	CHIP-TAN 4.7UF 6.3WV	
-10 : TK-860G K,M -11 : TK-862G K -12 : TK-860G K2,M2						C83			CC73GCH1H270J	CHIP C 27PF J	
-13 : TK-862G K2 -14 : TK-860G K3						C84			C92-0507-05	CHIP-TAN 4.7UF 6.3WV	
D509-514			B30-2050-05	LED		C86			C92-0662-05	CHIP-TAN 15UF 6.3WV	
D521			B30-2151-05	LED (RED/GREEN)		C87			CC73GCH1H330J	CHIP C 33PF J	
C1-19			CK73GB1H471K	CHIP C 470PF K		C88			CK73GB1H103K	CHIP C 0.010UF K	
C20			C92-0507-05	CHIP-TAN 4.7UF 6.3WV		C89			CK73GB1H471K	CHIP C 470PF K	
C21			CK73GB1H471K	CHIP C 470PF K		C91			CC73GCH1H020B	CHIP C 2.0PF B	
C22			CK73GB1C104K	CHIP C 0.10UF K		C92			CK73GB1H471K	CHIP C 470PF K	
C23,24			C92-0507-05	CHIP-TAN 4.7UF 6.3WV		C93			C92-0555-05	CHIP-TAN 0.047UF 35WV	
C25			CC73GCH1H060D	CHIP C 6.0PF D	K,K2,M	C94-96			CK73GB1H471K	CHIP C 470PF K	
C25			CC73GCH1H060D	CHIP C 6.0PF D	M2	C97			C92-0546-05	CHIP-TAN 68UF 6.3WV	
C25			CC73GCH1H080D	CHIP C 8.0PF D	K3	C98			CK73GB1H103K	CHIP C 0.010UF K	
C26			CK73GB1H471K	CHIP C 470PF K		C99			C92-0697-05	CHIP-TAN 3.3UF 16WV	
C28			CC73GCH1H060D	CHIP C 6.0PF D	K,K2,M	C100			CC73GCH1H020B	CHIP C 2.0PF B	
C28			CC73GCH1H060D	CHIP C 6.0PF D	M2	C101			CK73GB1H471K	CHIP C 470PF K	
C28			CC73GCH1H080D	CHIP C 8.0PF D	K3	C102			CC73GCH1H020B	CHIP C 2.0PF B	
C29			C92-0507-05	CHIP-TAN 4.7UF 6.3WV		C103			CK73GB1H471K	CHIP C 470PF K	
C30			CC73GCH1H030C	CHIP C 3.0PF C		C104			C92-0001-05	CHIP C 0.1UF 35WV	
C31			CK73GB1H102K	CHIP C 1000PF K		C105			CK73GB1H471K	CHIP C 470PF K	
C32			C92-0662-05	CHIP-TAN 15UF 6.3WV		C106			CC73GCH1H180J	CHIP C 18PF J	
C33			CC73GCH1H220J	CHIP C 22PF J		C107			CK73GB1H471K	CHIP C 470PF K	
C35			CK73GB1C104K	CHIP C 0.10UF K		C108			CC73GCH1H020B	CHIP C 2.0PF B	
C36			CK73GB1H102K	CHIP C 1000PF K		C109			CK73GB1H471K	CHIP C 470PF K	
C37			CK73FB1C334K	CHIP C 0.33UF K		C110			CC73GCH1H070D	CHIP C 7.0PF D	
C40,41			CK73GB1H103K	CHIP C 0.010UF K		C111			CC73GCH1H030C	CHIP C 3.0PF C	
C43			C92-0507-05	CHIP-TAN 4.7UF 6.3WV		C112			CK73GB1H471K	CHIP C 470PF K	
C44			CK73GB1H331K	CHIP C 330PF K		C113			C92-0507-05	CHIP-TAN 4.7UF 6.3WV	
C45			CK73GB1H102K	CHIP C 1000PF K		C114			C92-0697-05	CHIP-TAN 3.3UF 16WV	
C46			CK73GB1H103K	CHIP C 0.010UF K		C115			CK73GB1H471K	CHIP C 470PF K	
C47			C92-0561-05	CHIP-ELE 22UF 16WV		C116			CK73GB1H103K	CHIP C 0.010UF K	
C49			CK73GB1H102K	CHIP C 1000PF K		C117			CK73GB1H102K	CHIP C 1000PF K	
C51			CK73GB1C104K	CHIP C 0.10UF K		C118			CK73GB1H471K	CHIP C 470PF K	
C52			CC73GCH1H680J	CHIP C 68PF J		C119			CK73GB1H103K	CHIP C 0.010UF K	
C53			CK73GB1C104K	CHIP C 0.10UF K		C120			CC73GCH1H040C	CHIP C 4.0PF C	K,K3,M
C54			CK73GB1H103K	CHIP C 0.010UF K		C120			CC73GCH1H050C	CHIP C 5.0PF C	K2,M2
C56			CC73GCH1H220J	CHIP C 22PF J		C121			CK73GB1H471K	CHIP C 470PF K	
C58			CK73GB1E223K	CHIP C 0.022UF K		C122,123			CK73GB1C104K	CHIP C 0.10UF K	
C60,61			CK73GB1H102K	CHIP C 1000PF K		C124			CC73GCH1H030C	CHIP C 3.0PF C	K2,K3,M2
C62			CC73GCH1H101J	CHIP C 100PF J		C125			C92-0004-05	CHIP-TAN 1.0UF 16WV	K3
C63			CK73GB1C104K	CHIP C 0.10UF K		C125			C92-0005-05	CHIP-TAN 2.2UF 6.3WV	K,K2,M
C64			CK73GB1H103K	CHIP C 0.010UF K		C125			C92-0005-05	CHIP-TAN 2.2UF 6.3WV	M2
C66			CK73GB1H102K	CHIP C 1000PF K		C126			CC73GCH1H120J	CHIP C 12PF J	
C67			CK73GB1H471K	CHIP C 470PF K		C127			CK73GB1H103K	CHIP C 0.010UF K	
C68			CC73GCH1H101J	CHIP C 100PF J		C128			C92-0543-05	CHIP-TAN 3.3UF 10WV	
C69			CK73GB1E223K	CHIP C 0.022UF K		C129			CK73FF1C105Z	CHIP C 1.0UF Z	
C70			C92-0507-05	CHIP-TAN 4.7UF 6.3WV		C130			CK73GB1H103K	CHIP C 0.010UF K	
C71			CC73GCH1H101J	CHIP C 100PF J		C131			CK73GB1H102K	CHIP C 1000PF K	
C72			C92-0507-05	CHIP-TAN 4.7UF 6.3WV		C133			CK73GB1H471K	CHIP C 470PF K	
						C134			CK73FB1E104K	CHIP C 0.10UF K	
						C135			CC73GCH1H120J	CHIP C 12PF J	K3
						C135			CC73GCH1H180J	CHIP C 18PF J	K,M
						C135			CK73GB1H102K	CHIP C 1000PF K	K2,M2

TK-860G : K,K2,K3,M,M2

TK-862G : K,K2

PARTS LIST

TX-RX UNIT (X57-5960-XX)

Ref. No.	Address	New parts	Parts No.	Description	Destination	Ref. No.	Address	New parts	Parts No.	Description	Destination
C136			CC73GCH1H040C	CHIP C 4.0PF C	K,M	C208			CC73GCH1H060D	CHIP C 6.0PF D	K3
C138			CK73FB1E104K	CHIP C 0.10UF K		C208			CC73GCH1H070D	CHIP C 7.0PF D	K,M
C139,140			CK73GB1H471K	CHIP C 470PF K		C209			CC73FCH1H050C	CHIP C 5.0PF C	K,K3,M
C141			C92-0719-05	ELECTRO 47UF 25WV		C210			CK73GB1H103K	CHIP C 0.010UF K	
C142,143			CK73GB1H471K	CHIP C 470PF K		C211			CC73GCH1H180J	CHIP C 18PF J	K,K3,M
C144			CK73GB1H102K	CHIP C 1000PF K		C212			CK73GB1H471K	CHIP C 470PF K	
C145			CC73GCH1H070D	CHIP C 7.0PF D		C214			C93-0550-05	CHIP C 1.0PF C	K2,M2
C146			CK73GB1H471K	CHIP C 470PF K		C215			CC73FCH1H060D	CHIP C 6.0PF D	K,K3,M
C147			CC73GCH1H1R5B	CHIP C 1.5PF B	K2,M2	C216			CC73GCH1H0R5B	CHIP C 0.5PF B	
C148,149			CK73GB1H471K	CHIP C 470PF K		C217			CC73GCH1H020B	CHIP C 2.0PF B	
C150			CK73FF1C105Z	CHIP C 1.0UF Z		C218			CK73GB1C104K	CHIP C 0.10UF K	
C152			CC73GCH1H060D	CHIP C 6.0PF D	K2,K3,M2	C219			CC73FCH1H040C	CHIP C 4.0PF C	
C152			CC73GCH1H080D	CHIP C 8.0PF D	K,M	C220			CK73GB1H471K	CHIP C 470PF K	
C153			CC73GCH1H040C	CHIP C 4.0PF C	K,M	C221			C93-0550-05	CHIP C 1.0PF C	K,K2,M
C154			CK73GB1H102K	CHIP C 1000PF K	K,K3,M	C221			C93-0550-05	CHIP C 1.0PF C	M2
C154,155			CK73GB1H102K	CHIP C 1000PF K	K2,M2	C221			C93-0552-05	CHIP C 2.0PF C	K3
C155			CC73GCH1H040C	CHIP C 4.0PF C	K3	C222			CC73GCH1H0R5B	CHIP C 0.5PF B	
C155			CC73GCH1H060D	CHIP C 6.0PF D	K,M	C223			CC73GCH1H020B	CHIP C 2.0PF B	
C156			CK73GB1H471K	CHIP C 470PF K		C224			CK73GB1H471K	CHIP C 470PF K	
C157			CK73GB1H102K	CHIP C 1000PF K		C225			C93-0603-05	CHIP C 1000PF K	
C158			CK73GB1H471K	CHIP C 470PF K		C226			C93-0555-05	CHIP C 5.0PF C	K2,M2
C160,161			C92-0719-05	ELECTRO 47UF 25WV		C226			C93-0556-05	CHIP C 6.0PF D	K,M
C162,163			CK73GB1H471K	CHIP C 470PF K		C226			C93-0558-05	CHIP C 8.0PF D	K3
C164			CK73GB1H102K	CHIP C 1000PF K		C227			C93-0557-05	CHIP C 7.0PF D	K2,M2
C165			C92-0719-05	ELECTRO 47UF 25WV		C227			C93-0558-05	CHIP C 8.0PF D	K,M
C166			CE04EW1E471M	ELECTRO 470UF 25WV		C227			C93-0560-05	CHIP C 10PF D	K3
C167			CK73GB1H471K	CHIP C 470PF K		C229			C93-0556-05	CHIP C 6.0PF D	K,K2,M
C168			CC73GCH1H060D	CHIP C 6.0PF D	K2,K3,M2	C229			C93-0556-05	CHIP C 6.0PF D	M2
C168			CC73GCH1H080D	CHIP C 8.0PF D	K,M	C229			C93-0557-05	CHIP C 7.0PF D	K3
C169			CK73GB1H471K	CHIP C 470PF K		C230,231			CK73GB1C104K	CHIP C 0.10UF K	
C172			CE04EW1E471M	ELECTRO 470UF 25WV		C241			CK73GB1H102K	CHIP C 1000PF K	K2,K3,M2
C173			CK73GB1C104K	CHIP C 0.10UF K		C243			CK73GB1H102K	CHIP C 1000PF K	K2,K3,M2
C174			CK73GB1H471K	CHIP C 470PF K		C247			CK73GB1H102K	CHIP C 1000PF K	K2,M2
C175			CC73GCH1H020B	CHIP C 2.0PF B	K,K2,M	C248			C92-0585-05	CHIP-TAN 4.7UF 16WV	
C175			CC73GCH1H020B	CHIP C 2.0PF B	M2	C250			CK73FF1C105Z	CHIP C 1.0UF Z	
C177			CC73FCH1H220J	CHIP C 22PF J		C254			CK73GB1C104K	CHIP C 0.10UF K	
C178			CC73GCH1H060D	CHIP C 6.0PF D	K2,K3,M2	C259			CK73GB1C104K	CHIP C 0.10UF K	
C178			CC73GCH1H080D	CHIP C 8.0PF D	K,M	C260			CK73GB1H103K	CHIP C 0.010UF K	
C179			CK73GB1H471K	CHIP C 470PF K		C261			CK73FF1C105Z	CHIP C 1.0UF Z	
C181			CK73GB1H471K	CHIP C 470PF K		C265			CK73GB1H102K	CHIP C 1000PF K	K2,K3,M2
C182			CK73GB1H102K	CHIP C 1000PF K	K2,M2	C270			CK73GB1H471K	CHIP C 470PF K	
C183			CK73GB1C104K	CHIP C 0.10UF K		C271			CK73GB1H472K	CHIP C 4700PF K	
C185			CK73GB1C104K	CHIP C 0.10UF K		C272			C92-0004-05	CHIP-TAN 1.0UF 16WV	
C186			CK73GB1H471K	CHIP C 470PF K		C274			CC73GCH1H050C	CHIP C 5.0PF C	K3
C187			CC73GCH1H060D	CHIP C 6.0PF D	K2,K3,M2	C275			CK73GB1H102K	CHIP C 1000PF K	K2,K3,M2
C187			CC73GCH1H080D	CHIP C 8.0PF D	K,M	C276			C90-2046-05	ELECTRO 22UF 10WV	K3
C188			CC73GCH1H040C	CHIP C 4.0PF C	K,M	C290			C92-0004-05	CHIP-TAN 1.0UF 16WV	K2,M2
C189,190			CK73GB1H471K	CHIP C 470PF K		C291			CC73GCH1H100D	CHIP C 10PF D	K2,M2
C191			CK73GB1C104K	CHIP C 0.10UF K		C501			CK73GB1H102K	CHIP C 1000PF K	
C192			C92-0719-05	ELECTRO 47UF 25WV		C502			CK73GB1C104K	CHIP C 0.10UF K	
C195			CK73GB1C104K	CHIP C 0.10UF K		C503			CK73GB1H471K	CHIP C 470PF K	
C196,197			CK73GB1H471K	CHIP C 470PF K		C504			CK73GB1H103K	CHIP C 0.010UF K	
C198			C92-0719-05	ELECTRO 47UF 25WV		C505			CK73GB1C104K	CHIP C 0.10UF K	
C201			CK73GB1H471K	CHIP C 470PF K		C506,507			CK73GB1H103K	CHIP C 0.010UF K	
C202			CK73GB1C104K	CHIP C 0.10UF K		C508			CK73GB1H472K	CHIP C 4700PF K	
C203			CK73GB1H471K	CHIP C 470PF K		C509			C92-0507-05	CHIP-TAN 4.7UF 6.3WV	
C204			C92-0004-05	CHIP-TAN 1.0UF 16WV	K,K3,M	C514			CC73GCH1H680J	CHIP C 68PF J	
C204			C92-0501-05	CHIP-TAN 1.5UF 10WV	K2,M2	C515			CK73GB1H103K	CHIP C 0.010UF K	
C206			CK73GB1H102K	CHIP C 1000PF K		C516			CC73GCH1H270J	CHIP C 27PF J	
C207			CK73GB1H103K	CHIP C 0.010UF K		C517			CK73GB1C683K	CHIP C 0.068UF K	

PARTS LIST

TX-RX UNIT (X57-5960-XX)

Ref. No.	Address	New parts	Parts No.	Description	Destination	Ref. No.	Address	New parts	Parts No.	Description	Destination
C518			CC73GCH1H270J	CHIP C 27PF J		C598			CK73GB1H102K	CHIP C 1000PF K	
C519			CK73GB1H102K	CHIP C 1000PF K		C599			CC73GCH1H101J	CHIP C 100PF J	
C520			CK73GB1C104K	CHIP C 0.10UF K		C600			CK73GB1H102K	CHIP C 1000PF K	
C521			CK73GB1H102K	CHIP C 1000PF K		C601,602			CC73GCH1H101J	CHIP C 100PF J	
C522			C92-0507-05	CHIP-TAN 4.7UF 6.3WV		C603			CK73GB1H102K	CHIP C 1000PF K	
C523			CC73GCH1H221J	CHIP C 220PF J		C604-606			CC73GCH1H101J	CHIP C 100PF J	
C524			CK73GB1H103K	CHIP C 0.010UF K		C608-610			CC73GCH1H101J	CHIP C 100PF J	
C525			CK73GB1E123K	CHIP C 0.012UF K		C611,612			CK73GB1H471K	CHIP C 470PF J	
C526			CK73GB1C683K	CHIP C 0.068UF K		C613			CC73GCH1H101J	CHIP C 100PF J	
C527			CK73GB1H222K	CHIP C 2200PF K		C615			CK73GB1H471K	CHIP C 470PF K	
C528			CK73GB1H103K	CHIP C 0.010UF K		C616			CC73GCH1H101J	CHIP C 100PF J	
C529			CK73GB1H272K	CHIP C 2700PF K		C618			CK73GB1H102K	CHIP C 1000PF K	
C530			CK73GB1H152K	CHIP C 1500PF K		C620			CK73GB1H471K	CHIP C 470PF K	
C531			CK73GB1H272K	CHIP C 2700PF K		C621			CK73GB1H102K	CHIP C 1000PF K	
C532,533			CK73GB1C104K	CHIP C 0.10UF K		C623			CK73GB1H102K	CHIP C 1000PF K	
C534,535			CK73GB1H103K	CHIP C 0.010UF K		C626			CK73GB1C104K	CHIP C 0.10UF K	
C536,537			CK73GB1C104K	CHIP C 0.10UF K		C628			CK73GB1C104K	CHIP C 0.10UF K	
C538			C92-0566-05	CHIP-TAN 10UF 6.3WV		C629			CC73GCH1H470J	CHIP C 47PF J	
C539			CK73GB1H103K	CHIP C 0.010UF K		C630			C92-0507-05	CHIP-TAN 4.7UF 6.3WV	
C540,541			CK73GB1C104K	CHIP C 0.10UF K		C631			CK73GB1H103K	CHIP C 0.010UF K	
C542			CC73GCH1H331J	CHIP C 330PF J		C632			CK73FF1C105Z	CHIP C 1.0UF Z	
C543			CK73GB1H102K	CHIP C 1000PF K		C633			CK73GB1C104K	CHIP C 0.10UF K	
C544-546			CK73GB1H562K	CHIP C 5600PF K		C720			C92-0566-05	CHIP-TAN 10UF 6.3WV	
C547			CC73GCH1H030C	CHIP C 3.0PF C		CN1			E40-6047-05	PIN ASSY	
C548-550			CK73GB1H272K	CHIP C 2700PF K		CN2			E40-6021-05	FLAT CABLE CONNECTOR	
C551			CC73GCH1H151J	CHIP C 150PF J		CN3			E40-3247-05	PIN ASSY	
C552			CC73GCH1H030C	CHIP C 3.0PF C		CN4			E40-5737-05	PIN ASSY	
C553			CK73GB1H102K	CHIP C 1000PF K		CN5			E40-5738-05	PIN ASSY	
C554			CK73GB1H122K	CHIP C 1200PF K		CN7			E40-3247-05	PIN ASSY	
C555			C92-0566-05	CHIP-TAN 10UF 6.3WV		CN8			E40-3246-05	PIN ASSY	
C556			CK73GB1C333K	CHIP C 0.033UF K		CN501			E40-6021-05	FLAT CABLE CONNECTOR	
C557			CK73GB1C104K	CHIP C 0.10UF K		J1			E11-0442-05	3.5D PHONE JACK (3P)	
C558			CC73GCH1H101J	CHIP C 100PF J		J501			E08-0877-05	MODULAR JACK	
C559			CK73GB1H102K	CHIP C 1000PF K		F1			F53-0108-05	FUSE	
C560-563			CK73GB1C104K	CHIP C 0.10UF K		-			J31-0543-05	COLLAR (LH-5-1.5)	
C564			C92-0507-05	CHIP-TAN 4.7UF 6.3WV		CF1			L72-0959-05	CERAMIC FILTER	
C565,566			CK73GB1H472K	CHIP C 4700PF K		CF2			L72-0973-05	CERAMIC FILTER	
C567			CC73GCH1H101J	CHIP C 100PF J		L1			L40-1005-34	SMALL FIXED INDUCTOR (10UH/8)	
C568			C92-0507-05	CHIP-TAN 4.7UF 6.3WV		L2-4			L40-3381-86	SMALL FIXED INDUCTOR (0.33U/160)	
C569			CK73GB1E223K	CHIP C 0.022UF K		L5			L34-4530-05	COIL	
C570			CK73FF1C105Z	CHIP C 1.0UF Z		L6			L40-8275-77	SMALL FIXED INDUCTOR (82NH/1608)	
C571,572			CK73GB1H102K	CHIP C 1000PF K		L7			L40-5685-85	SMALL FIXED INDUCTOR (0.56U/252)	
C573			CK73FB1H563K	CHIP C 0.056UF K		L8			L40-8285-85	SMALL FIXED INDUCTOR (0.82U/252)	
C574			CC73GCH1H470J	CHIP C 47PF J		L9			L40-1575-77	SMALL FIXED INDUCTOR (15NH/1608)	
C575			CK73GB1H102K	CHIP C 1000PF K		L10			L40-2775-77	SMALL FIXED INDUCTOR (27NH/1608)	
C576			CK73GB1C104K	CHIP C 0.10UF K		L11,12			L40-1575-34	SMALL FIXED INDUCTOR (15NH/8)	
C577,578			CK73GB1H103K	CHIP C 0.010UF K		L13			L79-1169-05	HELICAL BLOCK	K2,M2
C579			CC73GCH1H101J	CHIP C 100PF J		L13			L79-1585-05	HELICAL BLOCK	K,M
C580			CK73GB1C104K	CHIP C 0.10UF K		L13			L79-1591-05	HELICAL BLOCK	K3
C581			CK73GB1H102K	CHIP C 1000PF K		L14			L40-1875-77	SMALL FIXED INDUCTOR (18NH/1608)	K,M
C582			CK73GB1C473K	CHIP C 0.047UF K		L14			L40-2775-77	SMALL FIXED INDUCTOR (27NH/1608)	K2,K3,M2
C583			C92-0566-05	CHIP-TAN 10UF 6.3WV		L15			L40-3975-77	SMALL FIXED INDUCTOR (39NH/1608)	K2,M2
C584			CK73GB1H103K	CHIP C 0.010UF K		L15			L40-4775-77	SMALL FIXED INDUCTOR (47NH/1608)	K,K3,M
C585			CC73GCH1H101J	CHIP C 100PF J		L16			L40-6875-34	SMALL FIXED INDUCTOR (68NH/8)	
C587			CK73GB1H103K	CHIP C 0.010UF K		L17			L40-1875-77	SMALL FIXED INDUCTOR (18NH/1608)	
C589			C92-0606-05	CHIP-TAN 4.7UF 10WV		L18			L40-1075-34	SMALL FIXED INDUCTOR (10NH/8)	
C590			CK73GB1H102K	CHIP C 1000PF K		L19			L40-1085-77	SMALL FIXED INDUCTOR (100NH/160)	K3
C594			CK73GB1H102K	CHIP C 1000PF K		L19			L40-4775-77	SMALL FIXED INDUCTOR (47NH/1608)	K2,M2
C596			CK73GB1H102K	CHIP C 1000PF K							
C597			CC73GCH1H101J	CHIP C 100PF J							

TK-860G : K,K2,K3,M,M2

TK-862G : K,K2

TK-860G/862G

PARTS LIST

TX-RX UNIT (X57-5960-XX)

Ref. No.	Address	New parts	Parts No.	Description	Destination	Ref. No.	Address	New parts	Parts No.	Description	Destination
L19			L40-5675-77	SMALL FIXED INDUCTOR (56NH/1608)	K,M	R36			RK73GB1J223J	CHIP R 22K J 1/16W	
L20			L40-1875-77	SMALL FIXED INDUCTOR (18NH/1608)	K,M	R37			RK73GB1J100J	CHIP R 10 J 1/16W	
L20			L40-2775-77	SMALL FIXED INDUCTOR (27NH/1608)	K3	R38-40			RK73GB1J103J	CHIP R 10K J 1/16W	
L21			L34-4478-05	AIR-CORE COIL		R41			RK73GB1J224J	CHIP R 220K J 1/16W	
L22			L79-1169-05	HELICAL BLOCK	K2,M2	R42			RK73GB1J473J	CHIP R 47K J 1/16W	
L22			L79-1585-05	HELICAL BLOCK	K,M	R43			RK73GB1J683J	CHIP R 68K J 1/16W	
L22			L79-1591-05	HELICAL BLOCK	K3	R44			RK73GB1J153J	CHIP R 15K J 1/16W	
L24			L92-0179-05	FERRITE CHIP		R46			RK73GB1J223J	CHIP R 22K J 1/16W	
L26			L40-3375-34	SMALL FIXED INDUCTOR (33NH/8)	K,K3,M	R47			RK73GB1J101J	CHIP R 100 J 1/16W	
L27			L40-1575-34	SMALL FIXED INDUCTOR (15NH/8)	K,M	R48			RK73GB1J184J	CHIP R 180K J 1/16W	
L27			L40-1875-34	SMALL FIXED INDUCTOR (18NH/8)	K3	R49			RK73GB1J152J	CHIP R 1.5K J 1/16W	
L29			L34-1185-05	AIR-CORE COIL		R50			RK73GB1J473J	CHIP R 47K J 1/16W	
L30,31			L34-1039-05	AIR-CORE COIL		R51-53			RK73GB1J562J	CHIP R 5.6K J 1/16W	
L32			L34-4478-05	AIR-CORE COIL		R54,55			R92-1252-05	CHIP R 0 OHM	
L33			L92-0179-05	FERRITE CHIP		R56			RK73GB1J100J	CHIP R 10 J 1/16W	
L35			L40-2775-77	SMALL FIXED INDUCTOR (27NH/1608)	K3	R57			RK73GB1J471J	CHIP R 470 J 1/16W	
L501			L92-0138-05	FERRITE CHIP		R58			RK73GB1J332J	CHIP R 3.3K J 1/16W	
L503,504			L92-0138-05	FERRITE CHIP		R59			RK73GB1J472J	CHIP R 4.7K J 1/16W	
L510			L92-0138-05	FERRITE CHIP		R60			RK73GB1J334J	CHIP R 330K J 1/16W	
X1		*	L77-1826-05	TCXO (16.8M)		R61			RK73GB1J102J	CHIP R 1.0K J 1/16W	
X501			L77-1708-05	CRYSTAL RESONATOR (3.579545MHZ)		R62			RK73GB1J224J	CHIP R 220K J 1/16W	
X502			L78-0462-05	RESONATOR (9.8304M/8*2.5)		R63			RK73GB1J474J	CHIP R 470K J 1/16W	
XF1		*	L71-0551-15	MCF (49.95MHZ/5.0K)		R64,65			RK73GB1J223J	CHIP R 22K J 1/16W	
CP501-505			R90-0741-05	MULTIPLE RESISTOR		R66			RK73GB1J101J	CHIP R 100 J 1/16W	
CP508-514			R90-0741-05	MULTIPLE RESISTOR		R67			RK73GB1J472J	CHIP R 4.7K J 1/16W	
CP516-524			R90-0741-05	MULTIPLE RESISTOR		R68			RK73GB1J182J	CHIP R 1.8K J 1/16W	
CP526,527			R90-0741-05	MULTIPLE RESISTOR		R69			R92-1252-05	CHIP R 0 OHM	
CP529-536			R90-0741-05	MULTIPLE RESISTOR		R70,71			RK73GB1J103J	CHIP R 10K J 1/16W	
CP538			R90-0741-05	MULTIPLE RESISTOR		R72			R92-1252-05	CHIP R 0 OHM	
CP539			R90-0724-05	MULTI-COMP	1K X4	R73			RK73GB1J223J	CHIP R 22K J 1/16W	
R1			R92-1252-05	CHIP R	0 OHM	R75			R92-1252-05	CHIP R 0 OHM	
R2			RK73GB1J102J	CHIP R	1.0K J 1/16W	R76			RK73GB1J223J	CHIP R 22K J 1/16W	
R3			R92-1252-05	CHIP R	0 OHM	R77			RK73GB1J224J	CHIP R 220K J 1/16W	
R4			RK73GB1J333J	CHIP R	33K J 1/16W	R78			RK73GB1J104J	CHIP R 100K J 1/16W	
R5,6			R92-1252-05	CHIP R	0 OHM	R79			RK73GB1J102J	CHIP R 1.0K J 1/16W	
R7,8			RK73GB1J102J	CHIP R	1.0K J 1/16W	R80			RK73GB1J471J	CHIP R 470 J 1/16W	
R9,10			R92-1252-05	CHIP R	0 OHM	R81			RK73GB1J101J	CHIP R 100 J 1/16W	
R11			RK73GB1J102J	CHIP R	1.0K J 1/16W	R82			RK73GB1J102J	CHIP R 1.0K J 1/16W	
R12			RK73GB1J104J	CHIP R	100K J 1/16W	R83			RK73GB1J684J	CHIP R 680K J 1/16W	
R13			RK73GB1J472J	CHIP R	4.7K J 1/16W	R84			R92-1252-05	CHIP R 0 OHM	
R14			RK73GB1J474J	CHIP R	470K J 1/16W	R85,86			RK73GB1J122J	CHIP R 1.2K J 1/16W	
R15			RK73GB1J104J	CHIP R	100K J 1/16W	R87			RK73GB1J102J	CHIP R 1.0K J 1/16W	
R16			RK73GB1J220J	CHIP R	22 J 1/16W	R88			RK73GB1J271J	CHIP R 270 J 1/16W	
R17			RK73GB1J154J	CHIP R	150K J 1/16W	R89			RK73GB1J102J	CHIP R 1.0K J 1/16W	
R18			RK73GB1J103J	CHIP R	10K J 1/16W	R90			RK73GB1J104J	CHIP R 100K J 1/16W	
R19			RK73GB1J392J	CHIP R	3.9K J 1/16W	R91			RK73GB1J823J	CHIP R 82K J 1/16W	
R20			RK73GB1J224J	CHIP R	220K J 1/16W	R92			RK73GB1J822J	CHIP R 8.2K J 1/16W	
R21			RK73GB1J102J	CHIP R	1.0K J 1/16W	R93			RK73GB1J152J	CHIP R 1.5K J 1/16W	
R22			RK73GB1J474J	CHIP R	470K J 1/16W	R94			RK73GB1J392J	CHIP R 3.9K J 1/16W	
R23			RK73GB1J223J	CHIP R	22K J 1/16W	R95			RK73GB1J103J	CHIP R 10K J 1/16W	
R24			RK73GB1J563J	CHIP R	56K J 1/16W	R97,98			RK73GB1J101J	CHIP R 100 J 1/16W	
R25			R92-1252-05	CHIP R	0 OHM	R99			RK73GB1J331J	CHIP R 330 J 1/16W	
R26			RK73GB1J104J	CHIP R	100K J 1/16W	R100,101			RK73GB1J222J	CHIP R 2.2K J 1/16W	
R29			R92-1252-05	CHIP R	0 OHM	R103			RK73GB1J472J	CHIP R 4.7K J 1/16W	
R30			RK73GB1J103J	CHIP R	10K J 1/16W	R104			RK73GB1J682J	CHIP R 6.8K J 1/16W	
R31			RK73GB1J152J	CHIP R	1.5K J 1/16W	R105			RK73GB1J101J	CHIP R 100 J 1/16W	
R32			RK73GB1J103J	CHIP R	10K J 1/16W	R106			RK73GB1J102J	CHIP R 1.0K J 1/16W	
R33			R92-1252-05	CHIP R	0 OHM	R107			RK73GB1J473J	CHIP R 47K J 1/16W	
R34,35			RK73GB1J104J	CHIP R	100K J 1/16W	R108			RK73GB1J152J	CHIP R 1.5K J 1/16W	
						R109			RK73GB1J103J	CHIP R 10K J 1/16W	

PARTS LIST

TX-RX UNIT (X57-5960-XX)

Ref. No.	Address	New parts	Parts No.	Description	Desti-nation	Ref. No.	Address	New parts	Parts No.	Description	Desti-nation
R110			RK73GB1J470J	CHIP R 47 J 1/16W		R175			RK73GB1J682J	CHIP R 6.8K J 1/16W	
R111			RK73GB1J101J	CHIP R 100 J 1/16W		R176			RK73GB1J103J	CHIP R 10K J 1/16W	
R112			RK73GB1J471J	CHIP R 470 J 1/16W		R177			R92-1261-05	CHIP R 150 J 1/2W	
R113			RK73GB1J100J	CHIP R 10 J 1/16W		R178			RK73GB1J822J	CHIP R 8.2K J 1/16W	
R114			RK73GB1J472J	CHIP R 4.7K J 1/16W		R179			RK73GB1J223J	CHIP R 22K J 1/16W	
R115			RK73GB1J223J	CHIP R 22K J 1/16W		R180			RK73GB1J333J	CHIP R 33K J 1/16W	K3
R116			RK73GB1J473J	CHIP R 47K J 1/16W		R180,181			RK73GB1J562J	CHIP R 5.6K J 1/16W	K,K2,M
R117			RK73GB1J221J	CHIP R 220 J 1/16W		R180,181			RK73GB1J562J	CHIP R 5.6K J 1/16W	M2
R118			RK73GB1J681J	CHIP R 680 J 1/16W		R181			RK73GB1J562J	CHIP R 5.6K J 1/16W	K3
R119			RK73GB1J222J	CHIP R 2.2K J 1/16W		R182			R92-0670-05	CHIP R 0 OHM	
R120			R92-1252-05	CHIP R 0 OHM		R184			R92-1252-05	CHIP R 0 OHM	K,K2,M
R121			RK73GB1J100J	CHIP R 10 J 1/16W		R184			R92-1252-05	CHIP R 0 OHM	M2
R122			R92-1215-05	CHIP R 470 J 1/2W		R185			RK73GB1J473J	CHIP R 47K J 1/16W	
R123			RK73GB1J472J	CHIP R 4.7K J 1/16W		R186			R92-1252-05	CHIP R 0 OHM	K2,K3,M2
R124			RK73GB1J103J	CHIP R 10K J 1/16W		R186,187			R92-1252-05	CHIP R 0 OHM	K,M
R125			RK73GB1J333J	CHIP R 33K J 1/16W		R187			RK73GB1J220J	CHIP R 22 J 1/16W	K2,K3,M2
R126			RK73GB1J471J	CHIP R 470 J 1/16W		R188			RK73GB1J102J	CHIP R 1.0K J 1/16W	
R127,128			RK73GB1J104J	CHIP R 100K J 1/16W		R189			RK73GB1J101J	CHIP R 100 J 1/16W	
R129			RK73GB1J331J	CHIP R 330 J 1/16W		R190			RK73GB1J473J	CHIP R 47K J 1/16W	
R130			RK73GB1J152J	CHIP R 1.5K J 1/16W		R192			RK73GB1J103J	CHIP R 10K J 1/16W	
R131			RK73GB1J681J	CHIP R 680 J 1/16W		R193			RK73GB1J102J	CHIP R 1.0K J 1/16W	
R132			R92-0670-05	CHIP R 0 OHM		R194			RK73GB1J473J	CHIP R 47K J 1/16W	
R133-136			R92-1252-05	CHIP R 0 OHM		R195			RK73GB1J154J	CHIP R 150K J 1/16W	
R138			RK73GB1J102J	CHIP R 1.0K J 1/16W		R196			RK73GB1J332J	CHIP R 3.3K J 1/16W	
R140			RK73FB2A2R2J	CHIP R 2.2 J 1/10W		R197			R92-1252-05	CHIP R 0 OHM	
R141			R92-0685-05	CHIP R 22 J 1/2W		R198			RK73GB1J104J	CHIP R 100K J 1/16W	
R142			RK73GB1J473J	CHIP R 47K J 1/16W		R199			R92-1252-05	CHIP R 0 OHM	K2,M2
R143			RK73GB1J101J	CHIP R 100 J 1/16W		R199,200			R92-1252-05	CHIP R 0 OHM	K,K3,M
R144			RK73GB1J222J	CHIP R 2.2K J 1/16W		R207			R92-1252-05	CHIP R 0 OHM	
R145,146			RK73GB1J473J	CHIP R 47K J 1/16W		R208			R92-0670-05	CHIP R 0 OHM	
R147			RK73GB1J683J	CHIP R 68K J 1/16W		R210			R92-1252-05	CHIP R 0 OHM	
R148			RK73GB1J104J	CHIP R 100K J 1/16W		R219			R92-1252-05	CHIP R 0 OHM	
R149			RK73GB1J101J	CHIP R 100 J 1/16W	K2,M2	R221			R92-1252-05	CHIP R 0 OHM	
R149			RK73GB1J151J	CHIP R 150 J 1/16W	K,K3,M	R228,229			R92-0670-05	CHIP R 0 OHM	K2,M2
R150			RK73GB1J104J	CHIP R 100K J 1/16W		R230			R92-1252-05	CHIP R 0 OHM	K2,M2
R151			RK73FB2A102J	CHIP R 1.0K J 1/10W	K,K2,M	R501			RK73GB1J473J	CHIP R 47K J 1/16W	
R151			RK73FB2A102J	CHIP R 1.0K J 1/10W	M2	R502			RK73GB1J472J	CHIP R 4.7K J 1/16W	
R151			RK73FB2A391J	CHIP R 390 J 1/10W	K3	R503			RK73GB1J102J	CHIP R 1.0K J 1/16W	
R152			R92-1252-05	CHIP R 0 OHM		R504-507			RK73GB1J473J	CHIP R 47K J 1/16W	
R153			R92-0670-05	CHIP R 0 OHM		R508			RK73GB1J102J	CHIP R 1.0K J 1/16W	
R154			RK73GB1J152J	CHIP R 1.5K J 1/16W		R509,510			R92-1252-05	CHIP R 0 OHM	
R155			RK73GB1J103J	CHIP R 10K J 1/16W		R511			RK73GB1J473J	CHIP R 47K J 1/16W	
R156			RK73FB2A120J	CHIP R 12 J 1/10W	K3	R512			RK73GB1J104J	CHIP R 100K J 1/16W	
R156			RK73FB2A5R6J	CHIP R 5.6 J 1/10W	K,K2,M	R513			RK73GB1J223J	CHIP R 22K J 1/16W	
R156			RK73FB2A5R6J	CHIP R 5.6 J 1/10W	M2	R514			RK73GB1J473J	CHIP R 47K J 1/16W	
R158			R92-0670-05	CHIP R 0 OHM		R515,516			RK73GB1J223J	CHIP R 22K J 1/16W	
R159			RK73GB1J473J	CHIP R 47K J 1/16W		R517			RK73GB1J473J	CHIP R 47K J 1/16W	
R160			RK73FB2A102J	CHIP R 1.0K J 1/10W	K,K2,M	R518			RK73GB1J472J	CHIP R 4.7K J 1/16W	
R160			RK73FB2A102J	CHIP R 1.0K J 1/10W	M2	R519			RK73GB1J103J	CHIP R 10K J 1/16W	
R160			RK73FB2A391J	CHIP R 390 J 1/10W	K3	R520-523			RK73GB1J102J	CHIP R 1.0K J 1/16W	
R161,162			RK73GB1J104J	CHIP R 100K J 1/16W		R526			RK73GB1J154J	CHIP R 150K J 1/16W	
R163			R92-0670-05	CHIP R 0 OHM		R527			R92-1252-05	CHIP R 0 OHM	
R164			R92-1215-05	CHIP R 470 J 1/2W		R528			RK73GB1J472J	CHIP R 4.7K J 1/16W	
R166			RK73GB1J151J	CHIP R 150 J 1/16W		R529			RK73GB1J154J	CHIP R 150K J 1/16W	
R169			RK73GB1J103J	CHIP R 10K J 1/16W		R530			RK73GB1J473J	CHIP R 47K J 1/16W	
R170			RK73FB2A222J	CHIP R 2.2K J 1/10W		R531			RK73GB1J394J	CHIP R 390K J 1/16W	
R171			RK73GB1J153J	CHIP R 15K J 1/16W		R532			RK73GB1J103J	CHIP R 10K J 1/16W	
R172			RK73GB1J683J	CHIP R 68K J 1/16W		R533			RK73GB1J104J	CHIP R 100K J 1/16W	
R173			RK73GB1J472J	CHIP R 4.7K J 1/16W		R534			RK73GB1J823J	CHIP R 82K J 1/16W	
R174			RK73GB1J103J	CHIP R 10K J 1/16W		R535			RK73GB1J103J	CHIP R 10K J 1/16W	

TK-860G : K,K2,K3,M,M2

TK-862G : K,K2

TK-860G/862G

PARTS LIST

TX-RX UNIT (X57-5960-XX)

Ref. No.	Address	New parts	Parts No.	Description	Destination	Ref. No.	Address	New parts	Parts No.	Description	Destination
R536			RK73GB1J153J	CHIP R 15K J 1/16W		R602			RK73GB1J473J	CHIP R 47K J 1/16W	
R537			RK73GB1J105J	CHIP R 1.0M J 1/16W		R603			RK73GB1J101J	CHIP R 100 J 1/16W	
R538			RK73GB1J103J	CHIP R 10K J 1/16W		R604			RK73GB1J472J	CHIP R 4.7K J 1/16W	
R539			R92-1252-05	CHIP R 0 OHM		R605			RK73GB1J332J	CHIP R 3.3K J 1/16W	
R540			RK73GB1J223J	CHIP R 22K J 1/16W		R606			RK73GB1J102J	CHIP R 1.0K J 1/16W	
R541			RK73GB1J184J	CHIP R 180K J 1/16W		R607			RK73GB1J101J	CHIP R 100 J 1/16W	
R542			RK73GB1J102J	CHIP R 1.0K J 1/16W		R608			RK73GB1J122J	CHIP R 1.2K J 1/16W	
R543			RK73GB1J184J	CHIP R 180K J 1/16W		R610,611			RK73GB1J473J	CHIP R 47K J 1/16W	
R544			RK73GB1J103J	CHIP R 10K J 1/16W		R612			R92-1201-05	CHIP R 220 1/2W	
R545			RK73GB1J472J	CHIP R 4.7K J 1/16W		R613			RK73GB1J103J	CHIP R 10K J 1/16W	
R546			RN73GH1J913D	CHIP R 91K D 1/16W		R614,615			R92-1252-05	CHIP R 0 OHM	
R547			RK73GB1J103J	CHIP R 10K J 1/16W		R616			RK73GB1J474J	CHIP R 470K J 1/16W	
R548			RN73GH1J333D	CHIP R 33K D 1/16W		R617			RK73GB1J472J	CHIP R 4.7K J 1/16W	
R549			RN73GH1J913D	CHIP R 91K D 1/16W		R618			RK73GB1J683J	CHIP R 68K J 1/16W	
R550			RN73GH1J683D	CHIP R 68K D 1/16W		R619			RK73GB1J104J	CHIP R 100K J 1/16W	
R551,552			RK73GB1J223J	CHIP R 22K J 1/16W		R620,621			RK73GB1J103J	CHIP R 10K J 1/16W	
R553			RK73GB1J105J	CHIP R 1.0M J 1/16W		R622			RK73GB1J473J	CHIP R 47K J 1/16W	
R554			RN73GH1J913D	CHIP R 91K D 1/16W		R630			R92-1252-05	CHIP R 0 OHM	
R555,556			RK73GB1J104J	CHIP R 100K J 1/16W		R701			RK73GB1J473J	CHIP R 47K J 1/16W	
R557			RN73GH1J274D	CHIP R 270K D 1/16W		R704			RK73GB1J223J	CHIP R 22K J 1/16W	
R558			R92-1252-05	CHIP R 0 OHM		R720,721			R92-1252-05	CHIP R 0 OHM	
R559			RK73GB1J333J	CHIP R 33K J 1/16W		D1			HSB123	DIODE	
R560			RK73GB1J474J	CHIP R 470K J 1/16W		D2			02D220(Y,Z)	ZENER DIODE	
R561			RK73GB1J333J	CHIP R 33K J 1/16W		D3-5			HSB123	DIODE	
R562			R92-1252-05	CHIP R 0 OHM		D8			DAN235K	DIODE	
R563			RK73GB1J473J	CHIP R 47K J 1/16W		D9			1SS355	DIODE	
R564			RK73GB1J223J	CHIP R 22K J 1/16W		D10			DAN235K	DIODE	
R565			R92-1252-05	CHIP R 0 OHM		D11			MA742	DIODE	
R566			RK73GB1J563J	CHIP R 56K J 1/16W		D14			1SS355	DIODE	
R567			RK73GB1J334J	CHIP R 330K J 1/16W		D15			DAN202K	DIODE	
R568			RK73GB1J473J	CHIP R 47K J 1/16W		D16			DAN235K	DIODE	
R569			RK73GB1J102J	CHIP R 1.0K J 1/16W		D17			HSB123	DIODE	
R570			RK73GB1J155J	CHIP R 1.5M J 1/16W		D18			1SV280	VARIABLE CAPACITANCE DIODE	
R571			RN73GH1J682D	CHIP R 6.8K D 1/16W		D19,20			1SS355	DIODE	
R572			RK73GB1J473J	CHIP R 47K J 1/16W		D21			02DZ18(X,Y)	ZENER DIODE	
R573			RK73GB1J474J	CHIP R 470K J 1/16W		D23			1SV280	VARIABLE CAPACITANCE DIODE	
R574			RN73GH1J683D	CHIP R 68K D 1/16W		D24			02DZ15(X,Y)	ZENER DIODE	
R575			RK73GB1J101J	CHIP R 100 J 1/16W		D25			22ZR-10D	SURGE ABSORBER	
R576			RK73GB1J224J	CHIP R 220K J 1/16W		D27			1SS355	DIODE	
R577			RK73GB1J103J	CHIP R 10K J 1/16W		D28			1SV280	VARIABLE CAPACITANCE DIODE	
R578			RN73GH1J682D	CHIP R 6.8K D 1/16W		D29			DSM3MA1	DIODE	
R579			RK73GB1J223J	CHIP R 22K J 1/16W		D30			MA4PH633	DIODE	
R580			R92-1252-05	CHIP R 0 OHM		D31			1SV280	VARIABLE CAPACITANCE DIODE	
R581			RK73GB1J394J	CHIP R 390K J 1/16W		D33,34			XB15A709	DIODE	
R582			RK73GB1J273J	CHIP R 27K J 1/16W		D35,36			MA742	DIODE	
R583			RK73GB1J470J	CHIP R 47 J 1/16W		D39			UDZ4.7(B)	ZENER DIODE	
R584			RK73GB1J220J	CHIP R 22 J 1/16W		D40			MA742	DIODE	
R585			R92-1252-05	CHIP R 0 OHM		D41			1SS355	DIODE	
R586			RK73GB1J473J	CHIP R 47K J 1/16W		D42			HZU5ALL	DIODE	
R587			R92-1252-05	CHIP R 0 OHM		D501-504			MA2S111	DIODE	
R588			RK73GB1J103J	CHIP R 10K J 1/16W		D505			MA2S111	DIODE	862
R590			RK73GB1J333J	CHIP R 33K J 1/16W		D506,507			MA2S111	DIODE	
R591			R92-1252-05	CHIP R 0 OHM		D508			MA742	DIODE	
R592			RK73GB1J103J	CHIP R 10K J 1/16W		D523			DAN202U	DIODE	
R593			RK73GB1J181J	CHIP R 180 J 1/16W		D524,525			HSB123	DIODE	
R594			RK73GB1J392J	CHIP R 3.9K J 1/16W		D526			1812L075PR	VARISTOR	
R595			RK73GB1J181J	CHIP R 180 J 1/16W		D527,528			HSB123	DIODE	
R598			RK73GB1J473J	CHIP R 47K J 1/16W		D529			MA742	DIODE	
R599			RK73GB1J102J	CHIP R 1.0K J 1/16W		IC1,2			TA75S01F	IC (OP AMP)	
R600			R92-1252-05	CHIP R 0 OHM							

PARTS LIST

TX-RX UNIT (X57-5960-XX)
PLL/VCO (X58-4670-XX)

Ref. No.	Address	New parts	Parts No.	Description	Desti-nation	Ref. No.	Address	New parts	Parts No.	Description	Desti-nation
IC3			MB15A02	IC (PLL SYSTEM)		Q501			2SC4619	TRANSISTOR	
IC4			NJM4558M	IC (OP AMP X2)		Q502,503			DTC114EE	DIGITAL TRANSISTOR	
IC5			TA31136FN	IC (FM IF DETECTOR)		Q504			2SC4617(S)	TRANSISTOR	
IC6			M62363FP	IC (8BIT D/A CONVERTER)		Q505			2SB1132(Q,R)	TRANSISTOR	
IC7			NJM2904M	IC (OP AMP X 2)		Q506			DTC114EE	DIGITAL TRANSISTOR	
IC9			BU4094BCF	IC (8-STAGE SHIFT/STORE REGISTER)		Q508			2SC4617(S)	TRANSISTOR	
IC10			NJM78L05UA	IC (VOLTAGE REGULATOR/ +5V)		Q509			DTC363EU	DIGITAL TRANSISTOR	
IC11			AN8009M	IC (REGULATOR)		TH1			157-153-65001	THERMISTOR	
IC12			TA7808S	IC (REGULATOR)		PLL/VCO (X58-4670-XX)					
IC13			LA4422	IC (AF POWER AMP/ 5.8W)		-12 : K,M -13 : K2,M2 -14 : K3					
IC14			TC4013BF(N)	IC (MEMORY)		C102			CK73GB1H471K	CHIP C	470PF K
IC15			TA75S01F	IC (OP AMP)		C104			CC73GCH1H060D	CHIP C	6.0PF D
IC400	2C,2F		S-AU27AH(K1)	IC (POWER MODULE)	K2,M2	C104			CC73GCH1H070D	CHIP C	7.0PF D
IC400	2C		S-AU27AL(K3)	IC (POWER MODULE)	K3	C104			CC73GCH1H080D	CHIP C	8.0PF D
IC400	2C,2F		S-AU27AM(K3)	IC (POWER MODULE)	K,M	C105			CC73GCH1H070D	CHIP C	7.0PF D
IC501			AT29C020-90TI	IC (ROM)		C105			CC73GCH1H080D	CHIP C	8.0PF D
IC502			30622M4102GP	IC (CPU)		C107			CC73GCH1H030B	CHIP C	3.0PF B
IC503			RH5VL42C	IC (REGULATOR)		C107			CC73GCH1H040B	CHIP C	4.0PF B
IC505			AT2408N10SI2.5	IC (8KBIT SERIAL REGISTER)		C108			CC73GCH1HR75B	CHIP C	0.75PF B
IC507			NJM2904V	IC (APC)		C110			CC73GCH1H040B	CHIP C	4.0PF B
IC508			TC35453F	IC (AUDIO PROCESSOR)		C110			CC73GCH1H060D	CHIP C	6.0PF D
IC509			BU4066BCFV	IC (ANALOG SWITCH X4)		C110			CC73GCH1H060D	CHIP C	6.0PF D
IC510			BU4094BCFV	IC (8 BIT SHIFT/STORE REGISTER)		C111			CC73GCH1H050B	CHIP C	5.0PF B
IC511			LC73872M	IC (DTMF RECEIVER)		C112			CC73GCH1H1R5B	CHIP C	1.5PF B
IC512			S-81350HG-KD	IC (VOLTAGE REGULATOR)		C113			CC73GCH1H010B	CHIP C	1.0PF B
IC513			TA75W558FU	IC (OP AMP X2)		C113			CC73GCH1H010B	CHIP C	1.0PF B
IC514			TC75W51FU	IC (OP AMP X2)		C113			CC73GCH1H020B	CHIP C	2.0PF B
Q1			DTD114EK	DIGITAL TRANSISTOR		C114			CC73GCH1H040B	CHIP C	4.0PF B
Q2,3			DTA114EKA	DIGITAL TRANSISTOR		C114			CC73GCH1H050B	CHIP C	5.0PF B
Q4-6			DTC114EKA	DIGITAL TRANSISTOR		C115			CC73GCH1H060D	CHIP C	6.0PF D
Q7			2SC4649(N,P)	TRANSISTOR		C115			CC73GCH1H070D	CHIP C	7.0PF D
Q8			2SC2412K	TRANSISTOR		C116			CC73GCH1H050B	CHIP C	5.0PF B
Q9			2SC4215(Y)	TRANSISTOR		C116			CC73GCH1H050B	CHIP C	5.0PF B
Q10			2SC2412K	TRANSISTOR		C116			CC73GCH1H060D	CHIP C	6.0PF D
Q11			2SA1832(GR)	TRANSISTOR		C117			CK73GB1H471K	CHIP C	470PF K
Q12			2SC4738(GR)	TRANSISTOR		C118			CC73GCH1H050B	CHIP C	5.0PF B
Q13			2SC4649(N,P)	TRANSISTOR		C119,120			CK73GB1H471K	CHIP C	470PF K
Q14			2SC5110(O)	TRANSISTOR		C121			CC73GCH1H050B	CHIP C	5.0PF B
Q15			3SK228	FET		C122			CC73GCH1HOR5B	CHIP C	0.5PF B
Q16			DTC114EKA	DIGITAL TRANSISTOR		C123			CK73GB1H471K	CHIP C	470PF K
Q17			DTC363EU	DIGITAL TRANSISTOR		C124			CC73GCH1HOR5B	CHIP C	0.5PF B
Q18			2SA1745(6,7)	TRANSISTOR		C125			CK73GB1H102K	CHIP C	1000PF K
Q19			DTC114EKA	DIGITAL TRANSISTOR		C126			CK73GB1H471K	CHIP C	470PF K
Q20			DTA114EKA	DIGITAL TRANSISTOR		C127			CC73GCH1H050B	CHIP C	5.0PF B
Q21			DTC114EKA	DIGITAL TRANSISTOR		TC106			C05-0384-05	CERAMIC TRIMMER CAP (10P/8)	
Q22			2SC4093	TRANSISTOR		TC109			C05-0384-05	CERAMIC TRIMMER CAP (10P/8)	
Q23			2SA1641(S,T)	TRANSISTOR		CN101			E40-6019-05	PIN ASSY	
Q24			DTA114EKA	DIGITAL TRANSISTOR		-			F10-2279-04	SHIELDING CASE	
Q25			2SC3357	TRANSISTOR		L101-104			L40-1595-34	SMALL FIXED INDUCTOR (1.5UH/8)	
Q26			DTA114EKA	DIGITAL TRANSISTOR		L105			L40-3975-34	SMALL FIXED INDUCTOR (39NH/8)	
Q27			2SC2954	TRANSISTOR		L106			L40-2775-34	SMALL FIXED INDUCTOR (27NH/8)	
Q28			2SB1132(Q,R)	TRANSISTOR		L107,108			L40-1098-76	SMALL FIXED INDUCTOR (1UH/2522)	
Q29			DTC114EKA	DIGITAL TRANSISTOR		L109,110			L40-1595-34	SMALL FIXED INDUCTOR (1.5UH/8)	
Q31			2SC2412K	TRANSISTOR		L111			L34-4547-05	AIR-CORE COIL K2,M2	
Q32			2SB1565(E,F)	TRANSISTOR							
Q33			DTC114EKA	DIGITAL TRANSISTOR							
Q34			3SK228	FET							
Q35			DTC144EKA	DIGITAL TRANSISTOR							
Q36			2SC2412K	TRANSISTOR							
Q37-39			2SK1824	FET							

TK-860G : K,K2,K3,M,M2
 TK-862G : K,K2

TK-860G/862G

PARTS LIST

PLL/VCO (X58-4670-XX)

Ref. No.	Address	New parts	Parts No.	Description	Destination	Ref. No.	Address	New parts	Parts No.	Description	Destination
L112			L34-4548-05	AIR-CORE COIL	K,M						
L112			L34-4549-05	AIR-CORE COIL	K3						
L115			L34-4546-05	AIR-CORE COIL	K2,M2						
L115			L34-4547-05	AIR-CORE COIL	K,M						
L116			L34-4548-05	AIR-CORE COIL	K3						
R101,102			RK73GB1J101J	CHIP R 100 J 1/16W							
R103			RK73GB1J102J	CHIP R 1.0K J 1/16W							
R104			RK73GB1J101J	CHIP R 100 J 1/16W							
R105			RK73GB1J154J	CHIP R 150K J 1/16W							
R106			RK73GB1J470J	CHIP R 47 J 1/16W							
R107-110			RK73GB1J103J	CHIP R 10K J 1/16W							
R111			RK73GB1J331J	CHIP R 330 J 1/16W							
R112			RK73GB1J181J	CHIP R 180 J 1/16W	K3						
R112,113			RK73GB1J221J	CHIP R 220 J 1/16W	K,K2,M						
R112,113			RK73GB1J221J	CHIP R 220 J 1/16W	M2						
R113			RK73GB1J221J	CHIP R 220 J 1/16W	K3						
R114			RK73GB1J470J	CHIP R 47 J 1/16W							
R115			RK73GB1J103J	CHIP R 10K J 1/16W							
R116			RK73GB1J392J	CHIP R 3.9K J 1/16W							
R117			RK73GB1J101J	CHIP R 100 J 1/16W							
D101-104			1SV283	VARIABLE CAPACITANCE DIODE							
D105			1SV214	VARIABLE CAPACITANCE DIODE							
Q101			2SK508NV(K52)	FET							
Q102			DTC114EUA	DIGITAL TRANSISTOR							
Q103			2SK508NV(K52)	FET							
Q104,105			2SC4081	TRANSISTOR							
Q106			2SC4226(R24)	TRANSISTOR							

ADJUSTMENT

Test Mode (TK-860G Only)

■ Test Mode Operating Features

This transceiver has a test mode. **To enter test mode, press [SCN] key and turn power on. Hold [SCN] key until test channel No. and test signalling No. appears on LCD.** Test mode can be inhibited by programming. To exit test mode, switch the power on again. The following functions are available in test mode.

• Controls

[PTT]	Used when making a transmission.
[MON]	Monitor on and off.
[SCN]	Sets to the tuning mode.
[A]	Function on.
[D/A]	RF power high and low.
[▼]	Changes signalling.
[▲]	Changes wide and narrow
[CH▲/▼]	Changes channel.
[Volume▲/▼]	Volume up/down.

• LCD indicator

"SCN"	Unused.
"AUX"	Lights at RF power low.
"MON"	Lights at monitor on.
"Right side dot"	Lights at narrow.

• LED indicator

Red LED	Lights during transmission.
Green LED	Lights when there is a carrier.

■ Frequency and Signalling

The set has been adjusted for the frequencies shown in the following table. When required, re-adjust them following the adjustment procedure to obtain the frequencies you want in actual operation.

• Frequency (MHz)

Channel No.	TK-860G/862G (K2)		TK-860G (M2)	
	RX	TX	RX	TX
1 (Center)	498.55000	498.60000	502.55000	502.60000
2 (Low)	485.05000	485.10000	485.05000	485.10000
3 (High)	511.95000	511.90000	519.95000	519.90000
4	498.50000	498.50000	502.00000	502.00000
5	498.70000	498.70000	502.20000	502.20000
6	498.90000	498.90000	502.40000	502.40000
7~16	—	—	—	—

• Signalling

Signalling No.	RX	TX
1	None	None
2	None	100Hz square
3	QT 67.0Hz	QT 67.0Hz
4	QT 151.4Hz	QT 151.4Hz
5	QT 210.7Hz	QT 210.7Hz
6	QT 250.3Hz	QT 250.3Hz
7	DQT D023N	DQT D023N
8	DQT D754I	DQT D754I
9	DTMF DEC, (159D)	DTMF ENC, (159D)
10	None	DTMF tone (9)
11	2-tone 321.7/928.1Hz	2-tone 321.7/928.1Hz
12	Single tone 1200Hz	Single tone 1200Hz

• Preparations for tuning the transceiver

Before attempting to tune the transceiver, connect the unit to a suitable power supply.

Whenever the transmitter is turned, the unit must be connected to a suitable dummy load (i.e. power meter).

The speaker output connector must be terminated with a 4Ω dummy load and connected to an AC voltmeter and an audio distortion meter or a SINAD measurement meter at all times during tuning.

• Transceiver tuning

(To place transceiver in tuning mode)

Channel appears on LCD. Set channel according to tuning requirements.

LCD display (Test mode)

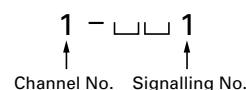

Press [SCN], now in tuning mode. Use [D/A] button to write tuning data through tuning modes, and [CH▲/▼] to adjust tuning requirements (1 to 256 appears on LCD).

Use [▼] button to select the adjustment item through tuning modes. Use [A] button to adjust 3-point or 5-point tuning, and use [▲] button to switch between wide/narrow.

LCD display (Tuning mode)

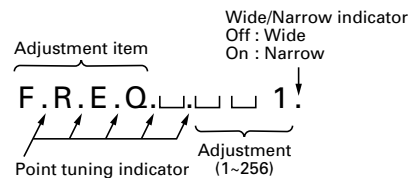

ADJUSTMENT

■ Tuning Mode

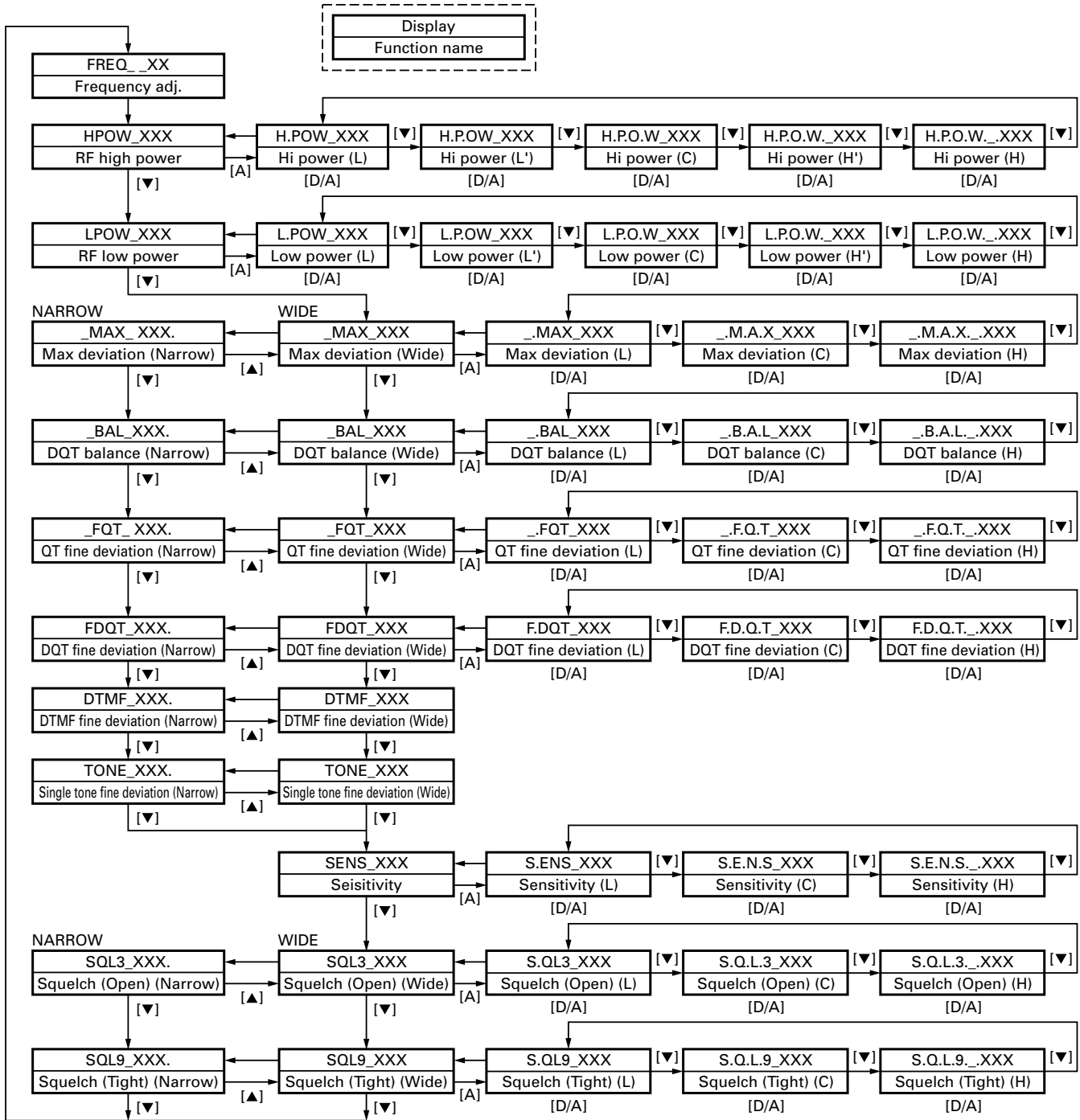

ADJUSTMENT

Test Equipment Required for Alignment

Test Equipment	Major Specifications	
1. Standard Signal Generator (SSG)	Frequency Range Modulation Output	400 to 520MHz Frequency modulation and external modulation -127dBm/0.1μV to greater than -7dBm/100mV
2. Power Meter	Input Impedance Operation Frequency Measurement Capability	50Ω 400 to 520MHz or more Vicinity of 100W
3. Deviation Meter	Frequency Range	400 to 520MHz
4. Digital Volt Meter (DVM)	Measuring Range Accuracy	1 to 20V DC High input impedance for minimum circuit loading
5. Oscilloscope		DC through 30MHz
6. High Sensitivity Frequency Counter	Frequency Range Frequency Stability	10Hz to 1000MHz 0.2ppm or less
7. Ammeter		20A
8. AF Volt Meter (AF VTVM)	Frequency Range Voltage Range	50Hz to 10kHz 1mV to 3V
9. Audio Generator (AG)	Frequency Range Output	20Hz to 20kHz or more 0 to 1V
10. Distortion Meter	Capability Input Level	3% or less at 1kHz 50mV to 10Vrms
11. 4Ω Dummy Load		Approx. 4Ω, 10W or more
12. Regulated Power Supply		13.6V, approx. 20A (adjustable from 9 to 17V) Useful if ammeter requipped

Tuning cable (E30-3383-05)

Adapter cable (E30-3383-05) is required for injecting an audio if PC tuning is used. See "PC Mode" section for the connection.

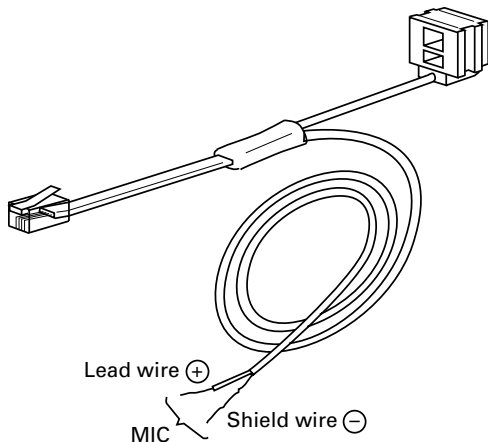

Test cable for microphone input (E30-3360-08)

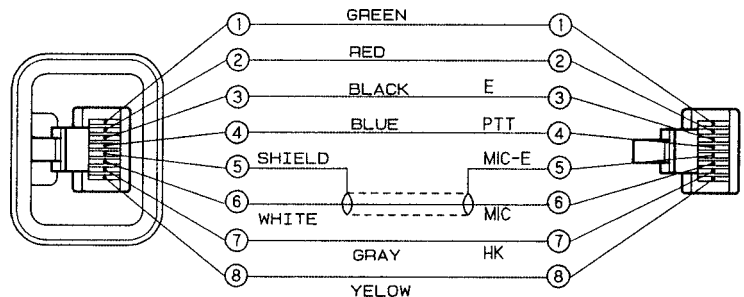

MIC connector (Front view)

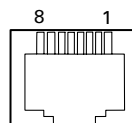

- 1 : BLC
- 2 : PSB
- 3 : E
- 4 : PTT
- 5 : ME
- 6 : MIC
- 7 : HOOK
- 8 : CM

TK-860G/862G

ADJUSTMENT

Adjustment Location

■ Switch (TK-860G)

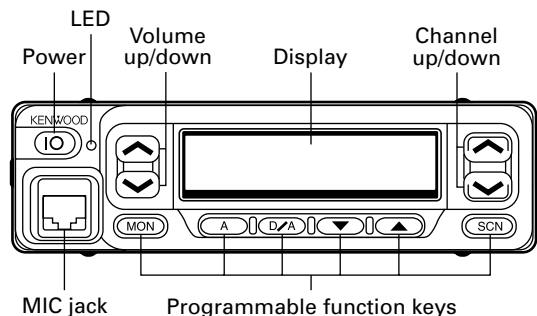

■ Note

• Flash memory

The firmware program (User mode, Test mode, Tuning mode, etc.) and the data programmed by the FPU (KPG-56D) for the flash memory, is stored in memory. When parts are changed, program the data again.

• EEPROM

The tuning data (Deviation, Squelch, etc.) for the EEPROM, is stored in memory. When parts are changed, readjust the transceiver.

■ Adjustment Point

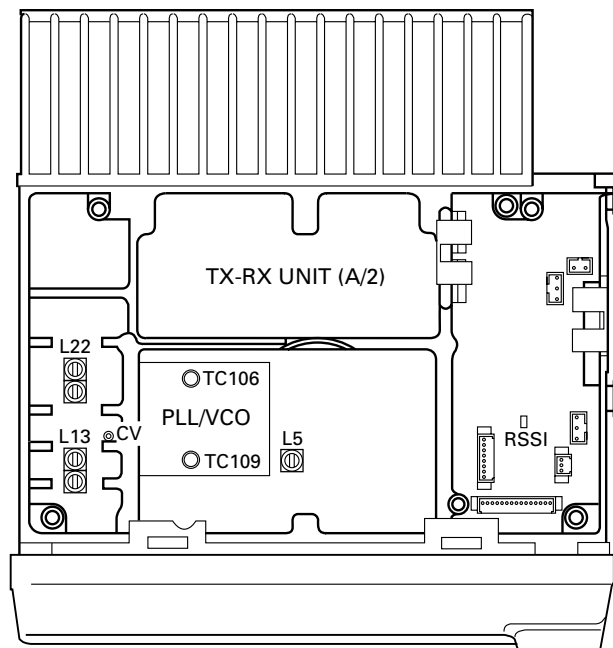

■ Repair Jig

• Chassis

Use jig (Part No. : A10-4010-02) for repairing the TK-860G/862G. The jig facilitates the voltage check when the voltage on the component side TX-RX unit is checked during repairs.

• Extension cable

Part No. : E30-3404-05

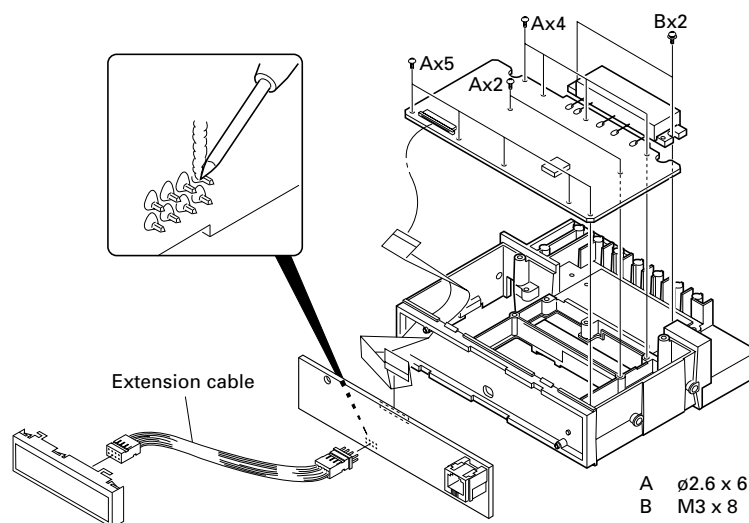

A $\phi 2.6 \times 6$
B M3 $\times 8$



ADJUSTMENT

Common Section

To adjust TK-862G, use KPG-56D, otherwise you cannot tune this transceiver from the front panel.

Item	Condition	Measurement			Adjustment			Specifications/Remarks
		Test-equipment	Unit	Terminal	Unit	Parts	Method	
1. PLL lock voltage	RX 1) Set test mode CH : CH3 - Sig1	DVM Power meter F. conter	TX-RX (A/2)	CV	PLL	TC106	6.5V	±0.1V
	TX 2) PTT : ON (Transmit)					TC109	6.5V	
	RX 3) CH : CH2 - Sig1					Check	0.9V or more	
	TX 4) PTT : ON (Transmit)						0.9V or more	

Receiver Section

Item	Condition	Measurement			Adjustment			Specifications/Remarks
		Test-equipment	Unit	Terminal	Unit	Parts	Method	
1. Discriminator • Wide	1) Set test mode CH : CH1 - Sig1 SSG output : -53dBm/501μV SSG MOD : 3kHz AF : 1.4V/4Ω	SSG AF VTVM Oscilloscope	Rear panel	ANT ACC (EXT.SP)	TX-RX (A/2)	L5	AF output maximum.	
2. Sensitivity • Wide	1) Set test mode Select "SENS" in tuning mode. "S.E.N.S." Adjust [250] SSG freq' : 511.950MHz K2 : 519.950MHz M2 SSG output : -116dBm/0.35μV SSG MOD : 3kHz AF output : 1V/4Ω	SSG AF VTVM Distortion meter Oscilloscope AG	Rear panel	ANT ACC (EXT.SP)	TX-RX (A/2)	L13 L22	RSSI voltage maximum.	
	2) "S.ENS" Adjust [***] SSG freq' : 485.050MHz				Front panel	CH 	RSSI voltage maximum.	
	3) "S.E.N.S._." Adjust [***] SSG freq' : 498.550MHz K2 : 502.550MHz M2							
3. Squelch 3 • Wide	1) Set test mode Select "SQL3" in tuning mode. "S.QL3" Adjust [***] SSG freq' : 485.050MHz SSG output : -127dBm/0.1μV SSG MOD : 3kHz (Wide) 1.5kHz (Narrow)	SSG AF VTVM Distortion meter Oscilloscope AG	Rear panel	ANT ACC (EXT.SP)	Front panel	CH 	Adjust to the squelch threshold point.	

ADJUSTMENT



Item	Condition	Measurement			Adjustment			Specifications/Remarks
		Test-equipment	Unit	Terminal	Unit	Parts	Method	
	2) "S.O.L.3" Adjust [***] SSG freq' : 498.550MHz K2 : 502.550MHz M2	SSG AF VTVM Distortion meter Oscilloscope AG	Rear panel	ANT	Front panel	CH 	Adjust to the squelch threshold point.	
	3) "S.O.L.3_."" Adjust [***] SSG freq' : 511.950MHz K2 : 519.950MHz M2			ACC (EXT.SP)				
• Narrow	4) "SQL3***." Adjust [***] SSG freq' : 498.550MHz K2 : 502.550MHz M2							
4. Squelch 9 • Wide	1) Set test mode Select "SQL9" in tuning mode. "S.QL9" Adjust [***] SSG freq' : 485.050MHz SSG output : -115dBm/0.4μV SSG MOD : 3kHz (Wide) 1.5kHz (Narrow)							
	2) "S.O.L.9" Adjust [***] SSG freq' : 498.550MHz K2 : 502.550MHz M2							
	3) "S.O.L.9_."" Adjust [***] SSG freq' : 511.950MHz K2 : 519.950MHz M2							
• Narrow	4) "SQL9***." Adjust [***] SSG freq' : 498.550MHz K2 : 502.550MHz M2							
5. Squelch check	1) Set test mode CH : CH1 - Sig1~CH3 - Sig1 SSG output : -116dBm/0.35μV					Check	Squelch must be opened. (Wide/Narrow)	
	2) SSG output : OFF						Squelch must be closed. (Wide/Narrow)	
6. QT check	1) Set test mode CH : CH1 - Sig4 SSG MOD INT : 3kHz (Wide) 1.5kHz (Narrow) EXT : 151.4Hz SSG system MOD DEV : ±3.75kHz (Wide) : ±1.85kHz (Narrow) SSG output : 10dB SINAD level							
	2) CH : CH1 - Sig3 CH1 - Sig5 CH1 - Sig6					Check	Squelch must be opened.	

ADJUSTMENT





Transmitter Section

Item	Condition	Measurement			Adjustment			Specifications/Remarks
		Test-equipment	Unit	Terminal	Unit	Parts	Method	
1. Frequency	1) Set test mode Select "FREQ" in tuning mode. PTT : ON Adjust [_**]	Power meter F. counter	Rear panel	ANT	Front panel	CH 	Check	498.600MHz±100Hz K2 502.600MHz±100Hz M2
2. Power output	1) Maximum power Set test mode Select "HPOW" in tuning mode. "H.POW" Adjust [256] PTT : ON						Check	More than 26.0W
3. High power	1) Set test mode Select "HPOW" in tuning mode. "H.POW" PTT : ON Adjust [***]						25.0W	±1.0W
	2) "H.P.O.W" PTT : ON Adjust [***]							
	3) "H.P.O.W" PTT : ON Adjust [***]							
	4) "H.P.O.W." PTT : ON Adjust [***]							
	5) "H.P.O.W._." PTT : ON Adjust [***]						25W K2 22W M2	±1.0W
4. Low power	1) Set test mode Select "LPOW" in tuning mode. "L.POW" PTT : ON Adjust [***]	Power meter					5.0W	±0.5W
	2) "L.P.O.W" PTT : ON Adjust [***]							
	3) "L.P.O.W" PTT : ON Adjust [***]							
	4) "L.P.O.W." PTT : ON Adjust [***]							
	5) "L.P.O.W._." PTT : ON Adjust [***]							
5. Power check	1) Set test mode CH : CH1 - Sig1 CH2 - Sig1 CH3 - Sig1 PTT : ON	Power meter Ammeter	Rear panel	ANT DC IN			Check	25W±1W, 8A or less

ADJUSTMENT

Item	Condition	Measurement			Adjustment			Specifications/Remarks
		Test-equipment	Unit	Terminal	Unit	Parts	Method	
6. Modulation balanced • Wide	1) Set test mode MIC input : OFF Select "BAL" in tuning mode. "_.BAL" Deviation meter filter LPF : 3kHz HPF : OFF De-emphasis : OFF PTT : ON Adjust [***]	Power meter Deviation meter Oscilloscope	Rear panel	ANT	Front panel	CH 	Make the de-modulation waveform neat.	(Wide/Narrow) 
	2) "_.B.A.L." PTT : ON Adjust [***]							
	3) "_.B.A.L._." PTT : ON Adjust [***]							
	4) "_.BAL***." PTT : ON Adjust [***]							
• Narrow								
7. Maximum deviation • Wide	1) Set test mode Connect AG to the MIC terminal. Select "MAX" in tuning mode. "_.MAX" AG : 1kHz/50mV Deviation meter filter LPF : 15kHz HPF : OFF De-emphasis : OFF PTT : ON Adjust [***]						3.95kHz (Wide) 1.75kHz (Narrow) (According to the larger +, -)	±50Hz (Wide/Narrow)
	2) "_.M.A.X." PTT : ON Adjust [***]							
	3) "_.M.A.X._." PTT : ON Adjust [***]							
	4) "_.MAX***." PTT : ON Adjust [***]							
• Narrow								
8. MIC sensitivity check	1) Set test mode CH : CH1 - Sig1 AG : 1kHz/5mV PTT : ON Adjust [***]						Check	±3kHz±0.2kHz (Wide) ±1.5kHz±0.05kHz (Narrow)

ADJUSTMENT

Item	Condition	Measurement			Adjustment			Specifications/Remarks
		Test-equipment	Unit	Terminal	Unit	Parts	Method	
9. QT deviation • Wide	1) Set test mode Select "FQT" in tuning mode. "_FQT" Deviation meter filter LPF : 3kHz HPF : OFF PTT : ON Adjust [***]	Power meter Deviation meter Oscilloscope	Rear panel	ANT	Front panel	CH 	0.75kHz	±50Hz (Wide/Narrow)
	2) "_F.Q.T." PTT : ON Adjust [***]							
	3) "_F.Q.T._." PTT : ON Adjust [***]							
	• Narrow	4) "_FQT***." PTT : ON Adjust [***]	AF VTVM AG	Front panel	MIC		0.35kHz	
10. DQT deviation • Wide	1) Set test mode Select "FDQT" in tuning mode. "F.DQT" Deviation meter filter LPF : 3kHz HPF : OFF PTT : ON Adjust [***]				Front panel	CH 	0.75kHz	±50Hz (Wide/Narrow)
	2) "F.D.Q.T." PTT : ON Adjust [***]							
	3) "F.D.Q.T._." PTT : ON Adjust [***]							
	• Narrow	4) "FDQT***." PTT : ON Adjust [***]					0.35kHz	
11. DTMF deviation • Wide	1) Set test mode Select "DTMF" in tuning mode. Deviation meter filter LPF : 15kHz HPF : OFF PTT : ON Adjust [***]				Front panel	CH 	3.0kHz	±0.2kHz
	• Narrow	2) "DTMF***." PTT : ON Adjust [***]					1.5kHz	±0.1kHz
12. TONE deviation • Wide	1) Set test mode Select "TONE" in tuning mode. Deviation meter filter LPF : 15kHz HPF : OFF PTT : ON Adjust [***]				Front panel	CH 	3.0kHz	±0.1kHz (Wide/Narrow)
	• Narrow	2) "TONE***." PTT : ON Adjust [***]					1.5kHz	

TK-860G/862G PC BOARD VIEWS

DISPLAY UNIT (X54-3270-10) : TK-860G
Component side view

DISPLAY UNIT (X54-3270-10) : TK-860G
Foil side view

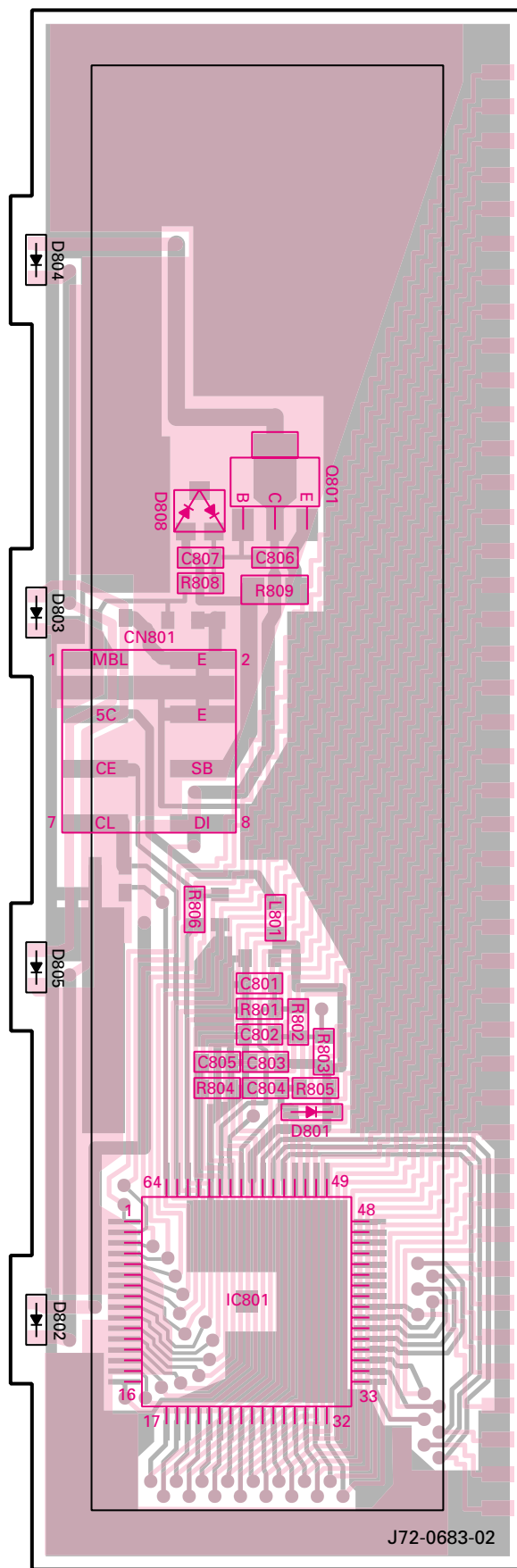
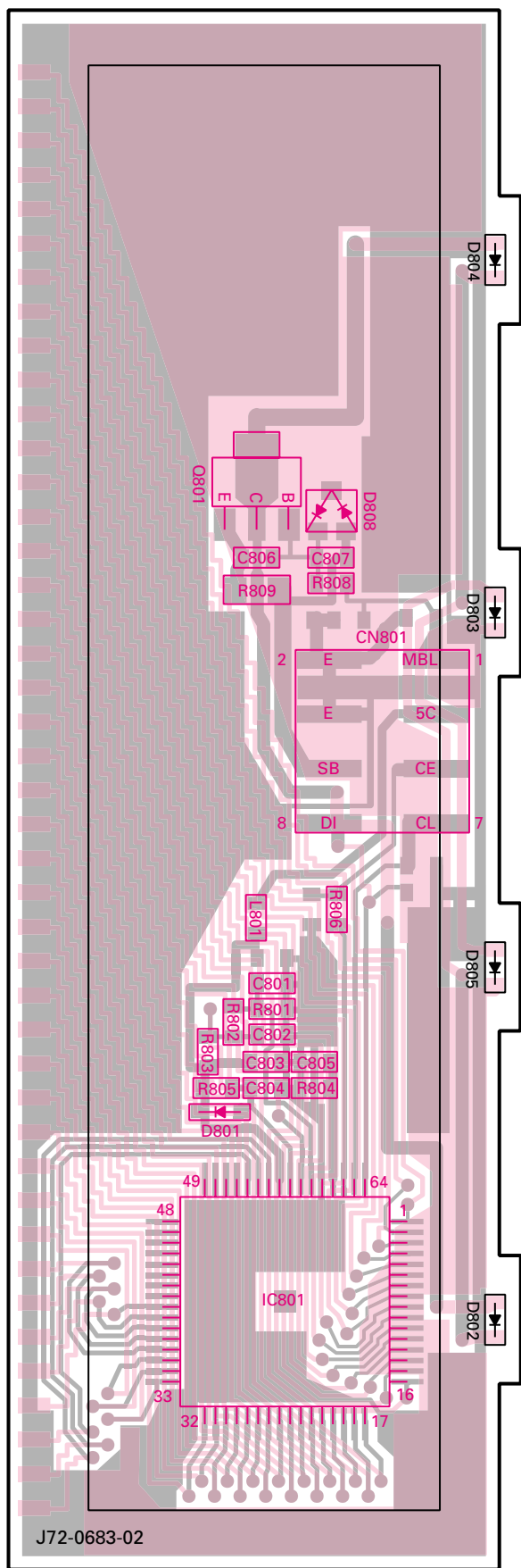

Component side Foil side

DISPLAY UNIT (X54-3280-10) : TK-862G
Component side view

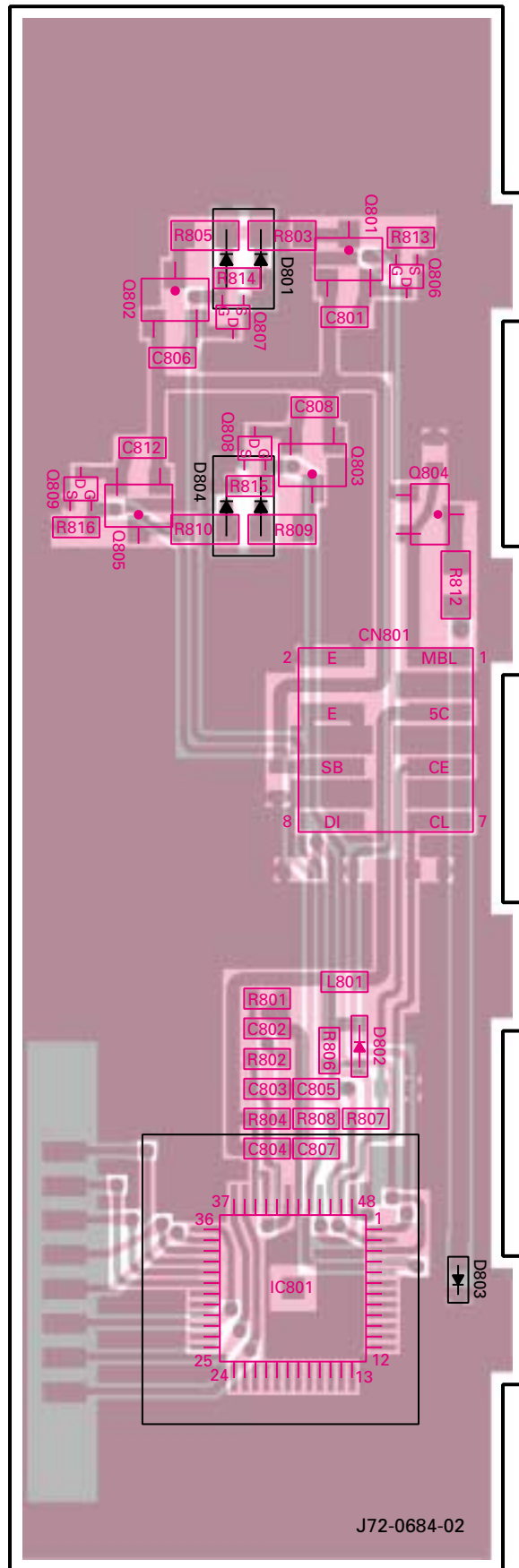

DISPLAY UNIT (X54-3280-10) : TK-862G
Foil side view

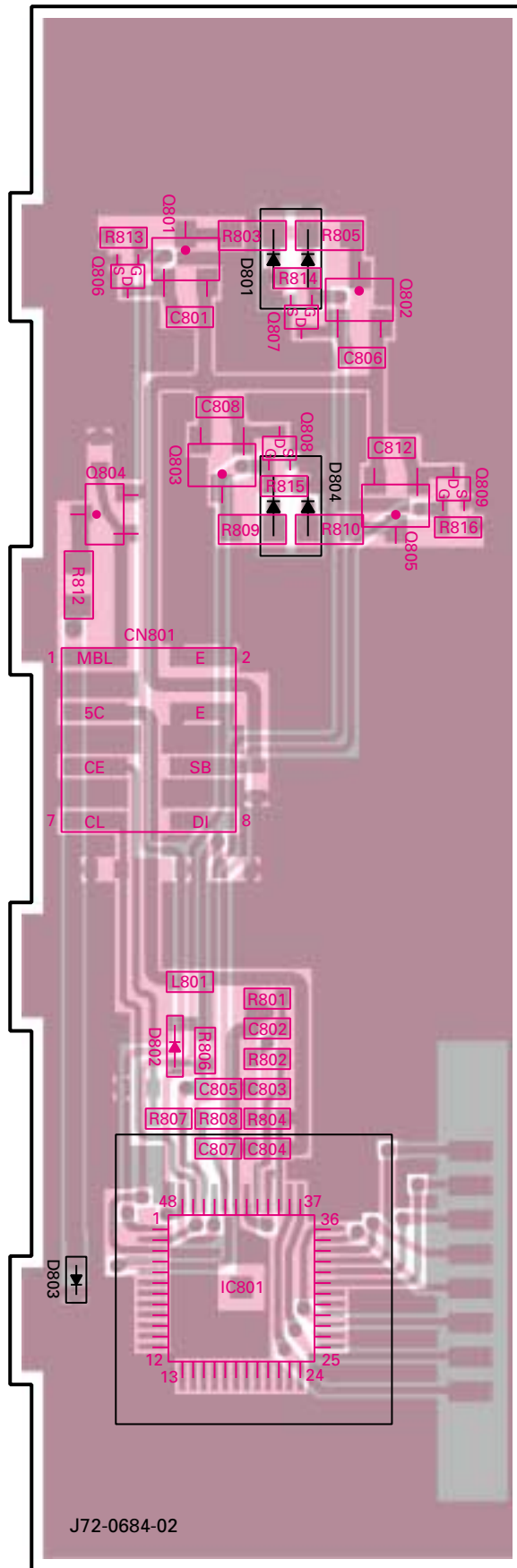

Component side Foil side

PC BOARD VIEWS TK-860G/862G

PLL/VCO (X58-4670-XX) -12 : K,M -13 : K2,M2 -14 : K3
Component side view

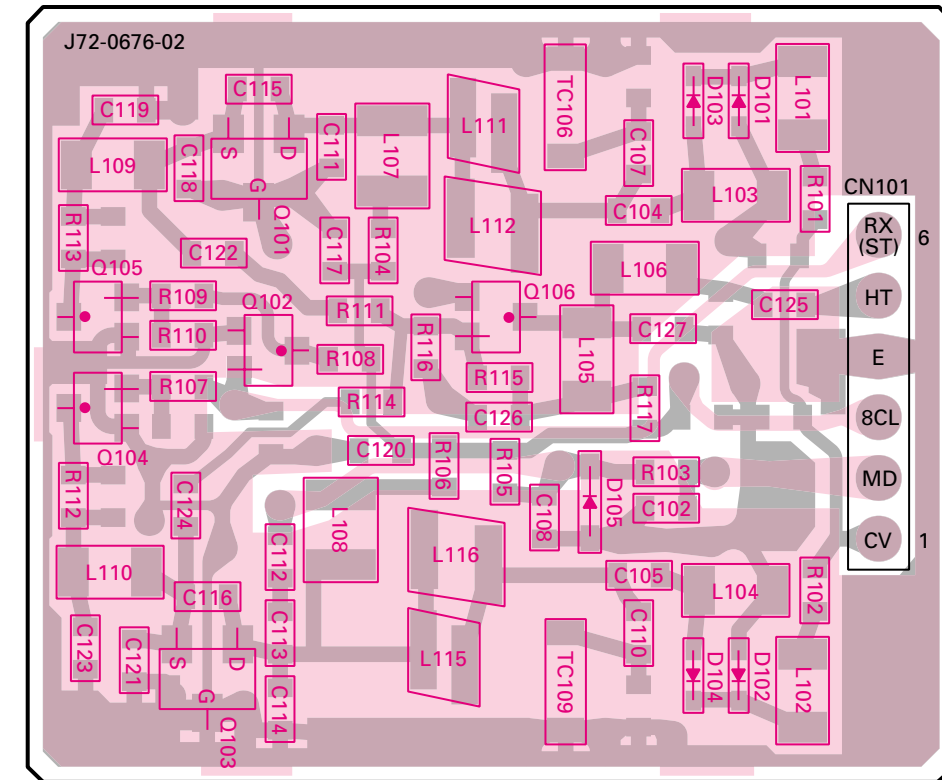

PLL/VCO (X58-4670-XX) -12 : K,M -13 : K2,M2 -14 : K3
Foil side view

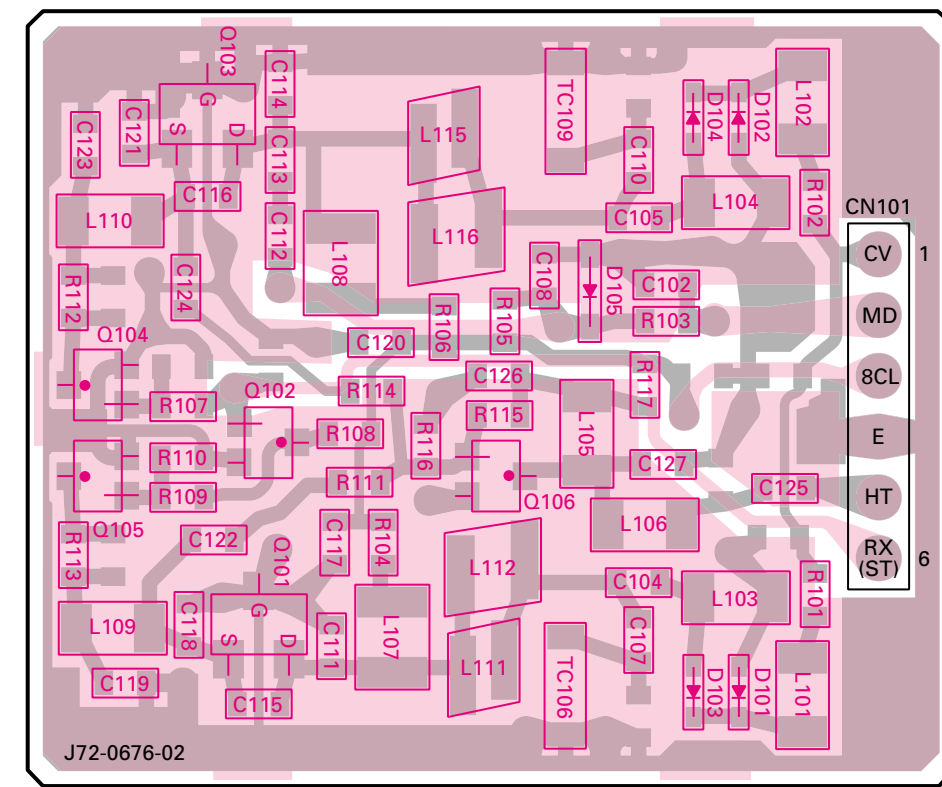

Component side
Foil side

TK-860G/862G PC BOARD VIEW

TX-RX UNIT (X57-5960-XX) (A/2)

Component side view

-10 : TK-860G K,M -11 : TK-862G K -12 : TK-860G K2,M2 -13 : TK-862G K2 -14 : TK-860G K3

Ref. No.	Address	Ref. No.	Address	Ref. No.	Address	Ref. No.	Address
IC3	10H	IC13	8R	Q32	4O	D30	5E
IC4	12M	IC400	2I	Q35	12L	D33	7C
IC5	12I	Q2	12R	Q37	11L	D34	7C
IC6	10M	Q8	7F	Q38	12R	D40	11M
IC7	9L	Q9	10F	Q39	9N	D42	11G
IC11	10J	Q11	11G	D9	9G		
IC12	6O	Q12	11G	D25	5O		

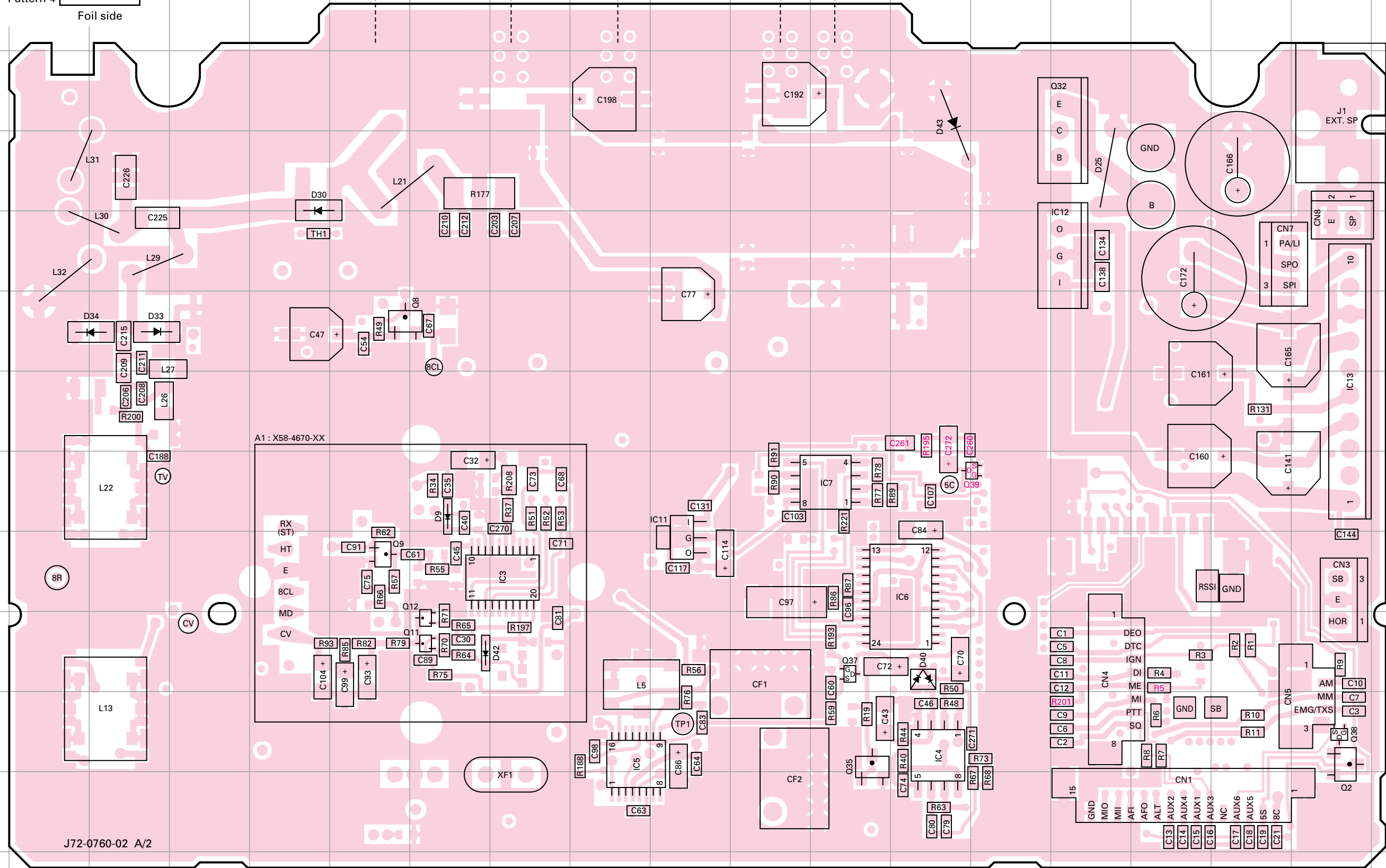
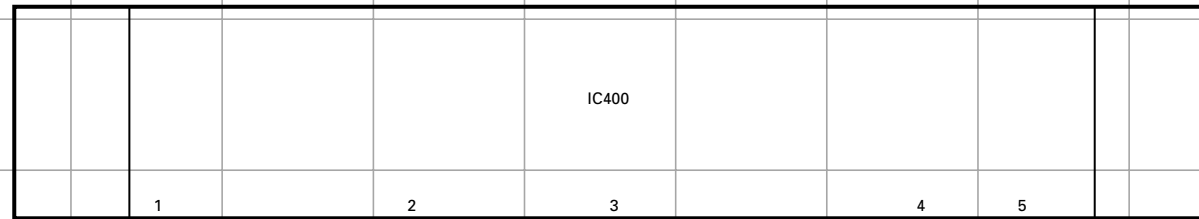
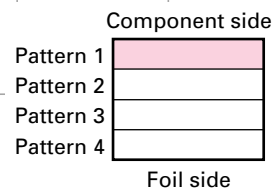

J72-0760-02 A/2

PC BOARD VIEW TK-860G/862G

TX-RX UNIT (X57-5960-XX) (A/2) Foil side view

-10 : TK-860G K,M -11 : TK-862G K -12 : TK-860G K2,M2 -13 : TK-862G K2 -14 : TK-860G K3

Ref. No.	Address	Ref. No.	Address	Ref. No.	Address	Ref. No.	Address	Ref. No.	Address	Ref. No.	Address		
IC1	11E	Q4	12H	Q17	9B	Q26	8C	D2	12B	D16	11N	D28	9Q
IC2	9J	Q5	11B	Q18	13N	Q27	6I	D3	13C	D17	7J	D29	5D
IC9	9G	Q6	11B	Q19	7C	Q28	7I	D4	13C	D18	12Q	D31	9R
IC10	8E	Q7	11K	Q20	8C	Q29	7H	D5	13D	D19	8B	D35	7Q
IC14	9D	Q10	13G	Q21	7C	Q31	6H	D8	11J	D20	8D	D36	7R
IC15	7O	Q13	13K	Q22	7L	Q33	7N	D10	12I	D21	7C	D39	8L
IC400	2K	Q14	10N	Q23	7E	Q34	10Q	D11	12G	D23	12R	D41	6H
Q1	11B	Q15	12O	Q24	8B	Q36	9K	D14	10H	D24	8D		
Q3	12H	Q16	13M	Q25	7K	D1	13D	D15	10B	D27	8D		

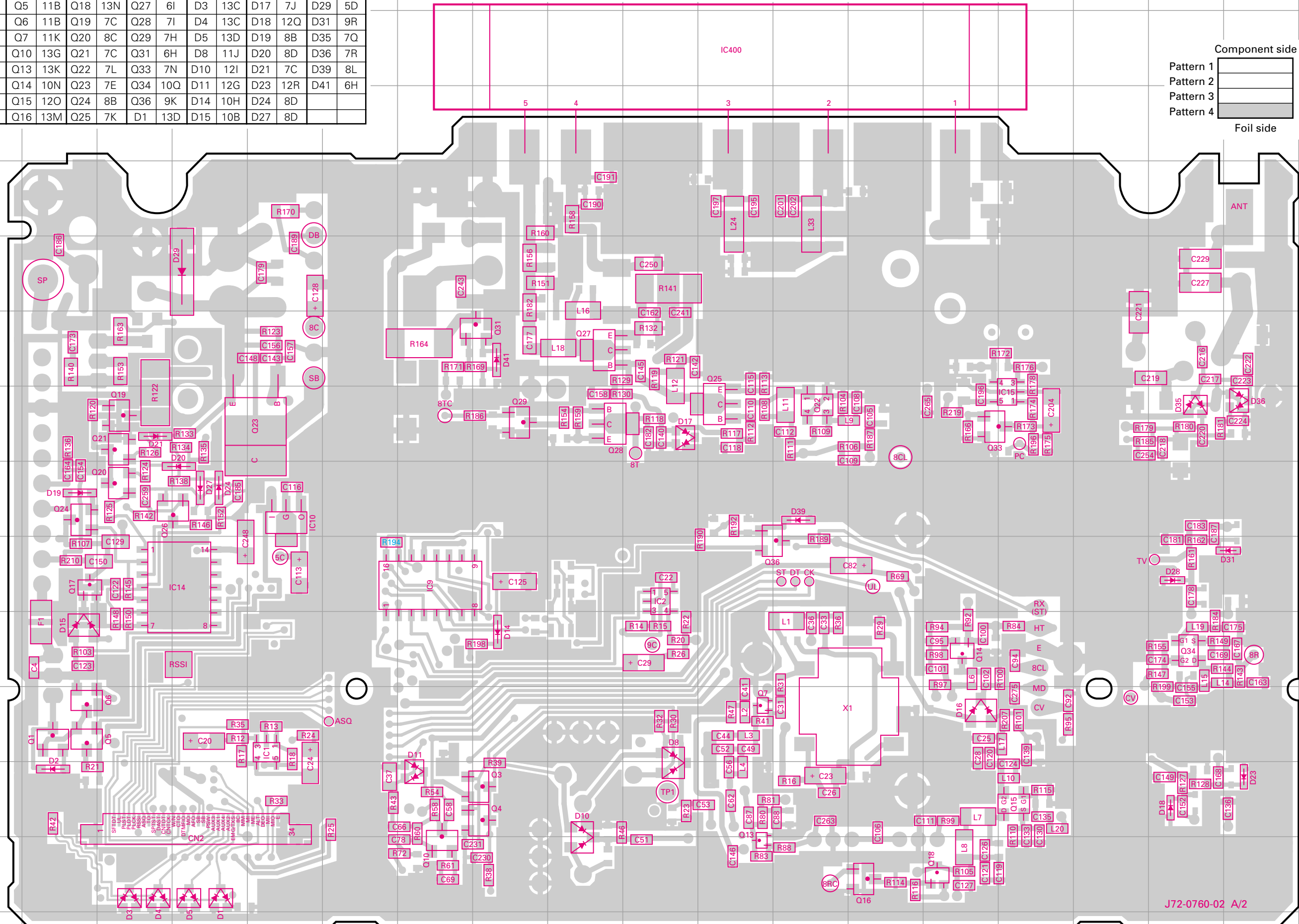
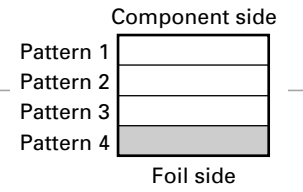

J72-0760-02 A/2

TK-860G/862G PC BOARD VIEW

TX-RX UNIT (X57-5960-XX) (A/2) Component side view + Foil side

-10 : TK-860G K,M -11 : TK-862G K -12 : TK-860G K2,M2 -13 : TK-862G K2 -14 : TK-860G K3

Ref. No.	Address	Ref. No.	Address	Ref. No.	Address	Ref. No.	Address	Ref. No.	Address	Ref. No.	Address	Ref. No.	Address	Ref. No.	Address
IC1	11O	IC13	8R	Q8	7F	Q19	7Q	Q31	6L	D3	13Q	D18	12C	D31	9B
IC2	9J	IC14	9P	Q9	10F	Q20	8Q	Q32	4O	D4	13Q	D19	8R	D33	7C
IC3	10H	IC15	7E	Q10	13M	Q21	7Q	Q33	7F	D5	13P	D20	8P	D34	7C
IC4	12M	IC400	2I	Q11	11G	Q22	7H	Q34	10C	D8	11J	D21	7Q	D35	7C
IC5	12I	Q1	11R	Q12	11G	Q23	7O	Q35	12L	D9	9G	D23	12B	D36	7B
IC6	10M	Q2	12R	Q13	13I	Q24	8R	Q36	8I	D10	12K	D24	8P	D39	8H
IC7	9L	Q3	12L	Q14	10F	Q25	7I	Q37	11L	D11	12M	D25	5O	D40	11M
IC9	9M	Q4	12L	Q15	12E	Q26	8Q	Q38	12R	D14	10L	D27	8P	D41	6L
IC10	8O	Q5	11R	Q16	13G	Q27	6K	Q39	9N	D15	10R	D28	9C	D42	11G
IC11	10J	Q6	11R	Q17	9R	Q28	7K	D1	13P	D16	11F	D29	5P		
IC12	6O	Q7	11I	Q18	13F	Q29	7L	D2	12R	D17	7J	D30	5E		

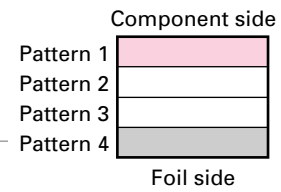

● Connect 1 and 4

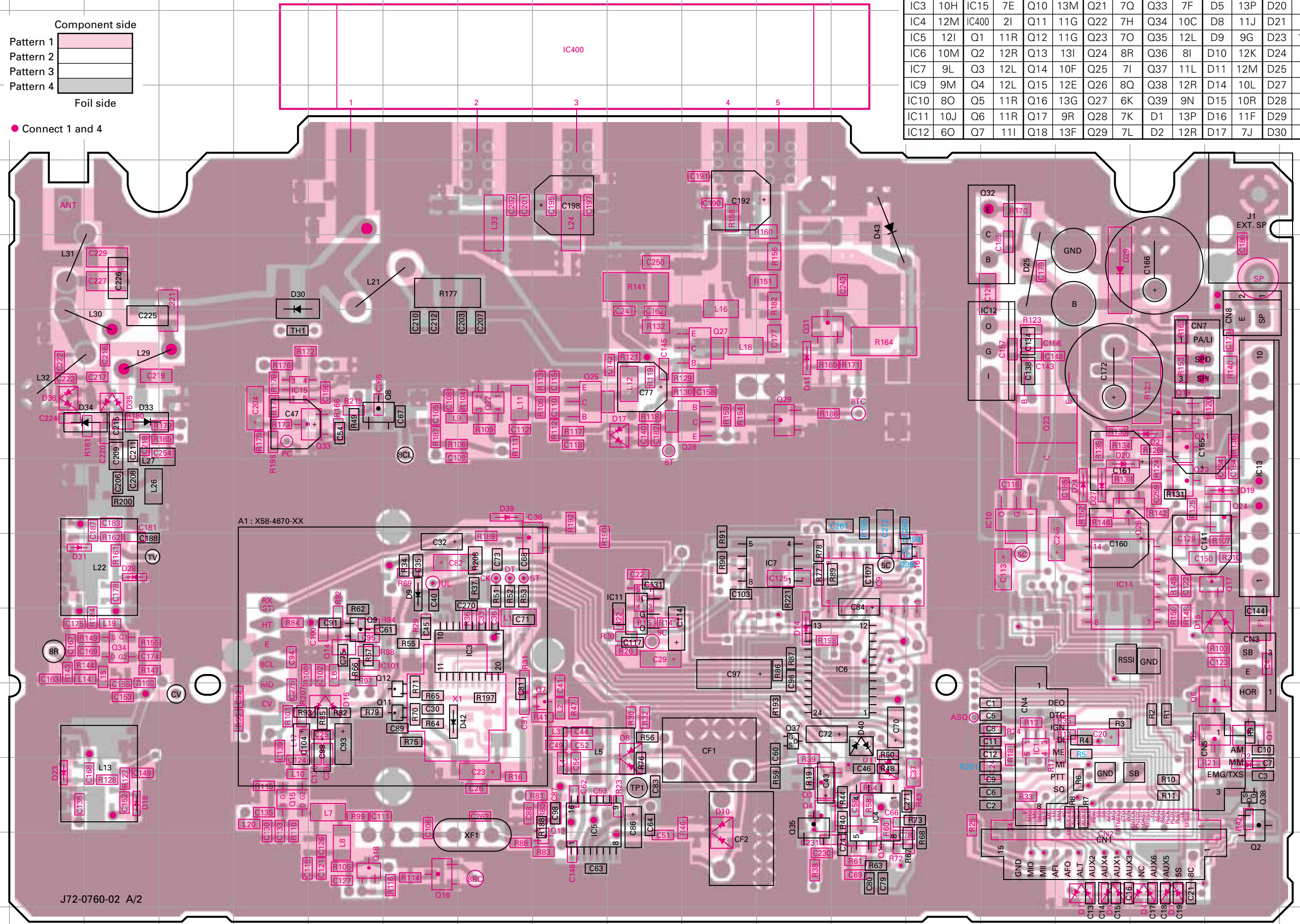

A1 : X58-4670-XX

J72-0760-02 A/2

TK-860G/862G PC BOARD VIEW

TX-RX UNIT (X57-5960-XX) (B/2) Component side view + Foil side
 -10 : TK-860G K,M -11 : TK-862G K -12 : TK-860G K2,M2 -13 : TK-862G K2 -14 : TK-860G K3

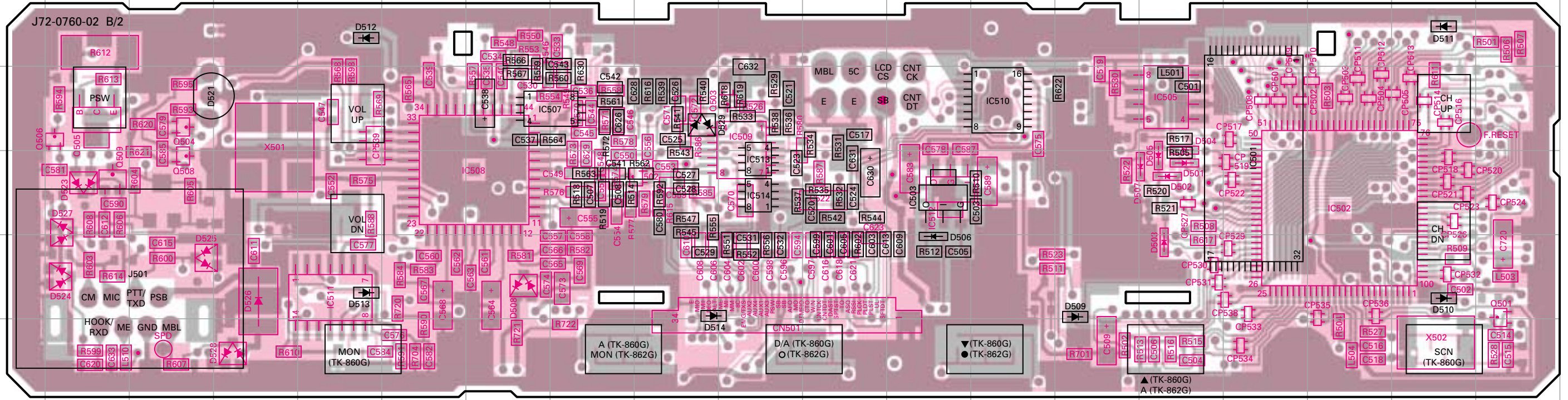

Ref. No.	Address	Ref. No.	Address	Ref. No.	Address	Ref. No.	Address	Ref. No.	Address	Ref. No.	Address
IC501	4P	IC510	3M	Q503	3J	D502	4O	D509	5N	D523	4B
IC502	4Q	IC511	5E	Q504	3C	D503	5O	D510	5R	D524	5B
IC503	4L	IC512	4L	Q505	3B	D504	3O	D511	2R	D525	5C
IC505	3O	IC513	4J	Q506	3B	D505	4O	D512	2E	D526	5D
IC507	3H	IC514	4J	Q508	4C	D506	5L	D513	5E	D527	4B
IC508	4G	Q501	5S	Q509	4B	D507	4O	D514	5I	D528	6D
IC509	3J	Q502	4I	D501	4O	D508	5G	D521	3C	D529	3I

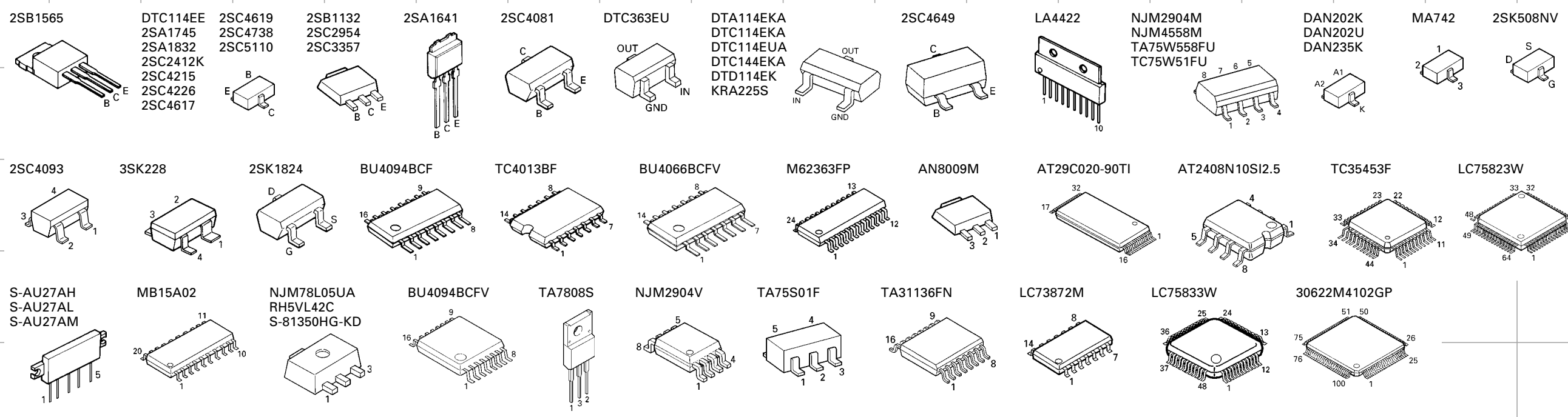
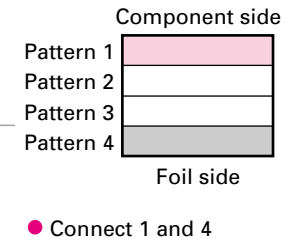

SCHEMATIC DIAGRAM TK-860G

Note : Components marked with a dot (·) are parts of pattern 1.

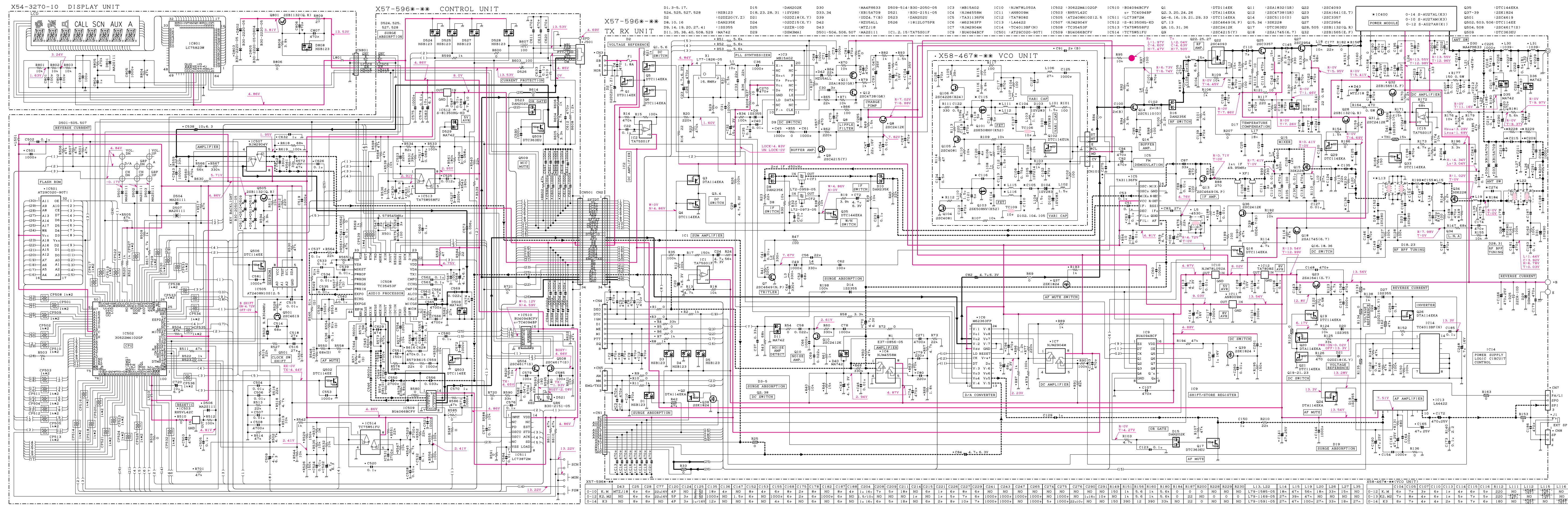

X57-596*-**		X58-467*-** (VCO UNIT)	
Part No.	Quantity	Part No.	Quantity
D43	1	C104	1
C25	1	C105	1
C77	1	C107	1
C120	1	C110	1
C124	1	C114	1
C125	1	C115	1
C135	1	C116	1
C147	1	L11	1
C152	1	L12	1
C153	1	L13	1
C155	1	L14	1
C158	1	L15	1
C175	1	L19	1
C178	1	L20	1
C182	1	L26	1
C187	1	L27	1
C198	1	L28	1
C204	1	L29	1
C208	1	L30	1
C209	1	L31	1
C211	1	L32	1
C212	1	L33	1
C215	1	L34	1
C221	1	L35	1
C222	1	L36	1
C227	1	L37	1
C241	1	L38	1
C243	1	L39	1
C247	1	L40	1
C265	1	L41	1
C274	1	L42	1
C275	1	L43	1
C276	1	L44	1
C290	1	L45	1
C291	1	L46	1
R149	1	L47	1
R151	1	L48	1
R156	1	L49	1
R160	1	L50	1
R184	1	L51	1
R187	1	L52	1
R190	1	L53	1
R200	1	L54	1
R228	1	L55	1
R230	1	L56	1
L13	1	L57	1
L22	1	L58	1
L14	1	L59	1
L15	1	L60	1
L19	1	L61	1
L20	1	L62	1
L26	1	L63	1
L27	1	L64	1
L28	1	L65	1
L29	1	L66	1
L30	1	L67	1
L31	1	L68	1
L32	1	L69	1
L33	1	L70	1
L34	1	L71	1
L35	1	L72	1
L36	1	L73	1
L37	1	L74	1
L38	1	L75	1
L39	1	L76	1
L40	1	L77	1
L41	1	L78	1
L42	1	L79	1
L43	1	L80	1
L44	1	L81	1
L45	1	L82	1
L46	1	L83	1
L47	1	L84	1
L48	1	L85	1
L49	1	L86	1
L50	1	L87	1
L51	1	L88	1
L52	1	L89	1
L53	1	L90	1
L54	1	L91	1
L55	1	L92	1
L56	1	L93	1
L57	1	L94	1
L58	1	L95	1
L59	1	L96	1
L60	1	L97	1
L61	1	L98	1
L62	1	L99	1
L63	1	L100	1

SPECIFICATIONS**GENERAL**

Frequency Range	K2 : 485 to 512MHz	M2 : 485 to 520MHz
Number of Channels	TK-862G : Maximum 8 channels	TK-860G : Maximum 128 channels
Number of Groups	TK-860G : Maximum 128 groups	
Channel Spacing	Wide : 25kHz	Narrow : 12.5kHz
PLL Channel Stepping	5, 6.25kHz	
Operating Voltage	13.6V DC \pm 15%	
Current Drain	Less than 0.4A on standby	
	Less than 1.0A on receive	
	Less than 8.0A on transmit	
Operating Temperature Range	-30°C to +60°C (-22°F to +140°F)	
Dimensions & Weight	140 (5-33/64) W x 40 (1-37/64) H x 145 (5-45/64) D mm (inch), 940g (2.07 lbs)	
Channel Frequency Spread	K2 : 27MHz	M2 : 35MHz

RECEIVER (Measurements made per EIA standard EIA/TIA-204-D)

Sensitivity (12dB SINAD)	Wide : 0.28 μ V	Narrow : 0.35 μ V
Selectivity	Wide : 80dB	Narrow : 65dB
Intermodulation	Wide : 75dB	Narrow : 63dB
Spurious Responce	85dB	
Audio Power Output	4.0W	
Frequency Stability	\pm 2.5ppm	

TRANSMITTER (Measurements made per EIA standard EIA-152-C)

RF Power Output	25W	
Spurious and Harmonics	65dB	
Modulation	Wide : 16K0F3E	Narrow : 11K0F3E
FM Noise	Wide : 50dB	Narrow : 45dB
Audio Distortion	Less than 3%	
Frequency Stability	\pm 2.5ppm	

TK-860G/862G

KENWOOD CORPORATION

14-6, Dogenzaka 1-chome, Shibuya-ku, Tokyo 150-8501, Japan

KENWOOD SERVICE CORPORATION

P.O. BOX 22745, 2201 East Dominguez Street, Long Beach, CA 90801-5745, U.S.A.

KENWOOD ELECTRONICS CANADA INC.

6070 Kestrel Road, Mississauga, Ontario, Canada L5T 1S8

KENWOOD ELECTRONICS DEUTSCHLAND GMBH

Rembrücker Str. 15, 63150 Heusenstamm, Germany

KENWOOD ELECTRONICS BELGIUM N.V.

Mechelsesteenweg 418 B-1930 Zaventem, Belgium

KENWOOD ELECTRONICS FRANCE S.A.

13, Boulevard Ney, 75018 Paris, France

KENWOOD ELECTRONICS U.K. LIMITED

KENWOOD House, Dwight Road, Watford, Herts., WD1 8EB United Kingdom

KENWOOD ELECTRONICS EUROPE B.V.

Amsterdamseweg 37, 1422 AC Uithoorn, The Netherlands

KENWOOD ELECTRONICS ITALIA S.p.A.

Via G. Sirtori, 7/9 20129 Milano, Italy

KENWOOD IBERICA S.A.

Bolivia, 239-08020 Barcelona, Spain

KENWOOD ELECTRONICS AUSTRALIA PTY. LTD.

(A.C.N. 001 499 074)

16 Giffnock Avenue, North Ryde, N.S.W. 2113 Australia

KENWOOD ELECTRONICS (HONG KONG) LTD.

Unit 3712-3724, Level 37, Tower one Metroplaza, 223 Hing Fong Road, Kwai Fong, N.T., Hong Kong

KENWOOD ELECTRONICS TECHNOLOGIES(S) PTE LTD.

Sales Marketing Division

1 Ang Mo Kio Street 63, Singapore 569110