

KENWOOD

TM-251A/251E

TM-451A/451E

**144, 430/440 MHz FM TRANSCEIVER
INSTRUCTION MANUAL**

KENWOOD CORPORATION

© PRINTED IN JAPAN B62-0455-08(K, P, E, M)

94/12 11 10 9 8 7 6 5 4 3 2 1 93/12

Notice to the user:

One or more of the following statements may be applicable to this equipment.

FCC WARNING

This equipment generates or uses radio frequency energy. Changes or modifications to this equipment may cause harmful interference unless the modifications are expressly approved in the instruction manual. The user could lose the authority to operate this equipment if an unauthorized change or modification is made.

INFORMATION TO THE DIGITAL DEVICE USER REQUIRED BY THE FCC

This equipment has been tested and found to comply with the limits for a Class B digital device, pursuant to Part 15 of the FCC Rules. These limits are designed to provide reasonable protection against harmful interference in a residential installation.

This equipment generates, uses and can generate radio frequency energy and, if not installed and used in accordance with the instructions, may cause harmful interference to radio communications. However, there is no guarantee that the interference will not occur in a particular installation. If this equipment does cause harmful interference to radio or television reception, which can be determined by turning the equipment off and on, the user is encouraged to try to correct the interference by one or more of the following measures:

- *Reorient or relocate the receiving antenna.*
- *Increase the separation between the equipment and receiver.*
- *Connect the equipment to an outlet on a circuit different from that to which the receiver is connected.*
- *Consult the dealer for technical assistance.*

Models Covered by this Manual

- TM-251A:** 144 MHz FM transceiver
(U.S.A./ Canada/ General)
- TM-251E:** 144 MHz FM transceiver
(Europe)
- TM-451A:** 440 MHz FM transceiver
(U.S.A./ Canada)
430 MHz FM transceiver
(General)
- TM-451E:** 430 MHz FM transceiver
(Europe)

Note:

- ▶ *The TM-251 series is used for all illustrations and all LCD example displays.*
- ▶ *Functions requiring the microphone keypad, such as Remote Control, cannot be used without a keypad-equipped microphone. This type of microphone is optional for some transceiver versions.*

THANK YOU

We are grateful you decided to purchase this KENWOOD FM transceiver. The TM-251/TM-451 series of mobile transceivers were developed to satisfy the requirement for a compact rig that's simple to operate yet has superior performance. Users of this series will discover the transceiver's Menu Set-up method for feature configuration recently incorporated in other KENWOOD products.

KENWOOD believes that the compact size coupled with the reasonable cost will guarantee your satisfaction with this product.

PRECAUTIONS

Please observe the following precautions to prevent fire, personal injury, and transceiver damage:

- Do not transmit with high output power for extended periods. The transceiver may overheat.
- Do not modify this transceiver unless instructed by this manual or by some other approved KENWOOD communication.
- Do not expose the transceiver to long periods of direct sunlight or place the transceiver close to heating appliances.
- Do not place the transceiver in excessively dusty or humid areas, or on unstable surfaces.
- If an abnormal odor or smoke is detected coming from the transceiver, turn OFF the power immediately. Contact a KENWOOD service station or your dealer.
- The transceiver is designed for a 13.8 V power source. Never use a 24 V battery to power the transceiver.

CONTENTS

FEATURES	1	REAR PANEL	15
ACCESSORIES	1	MICROPHONE	16
CONVENTIONS FOLLOWED IN THIS MANUAL ...	2	DISPLAY	17
PREPARATION FOR MOBILE OPERATION	3	MENU SET-UP	22
MOBILE INSTALLATION	3	MENU DESCRIPTION	22
Installation Example	3	MENU A ACCESS	22
DC POWER CABLE CONNECTION	4	MENU A CONFIGURATION	23
Replacing Fuses	6	MENU B ACCESS	24
ANTENNA CONNECTION	6	MENU B CONFIGURATION	24
PREPARATION FOR FIXED STATION OPERATION	7	CONFIRMATION BEFORE OPERATION	26
DC POWER SUPPLY CONNECTION	7	REAR PANEL	26
Replacing Fuses	8	FRONT PANEL	27
ANTENNA CONNECTION	8	RECEIVING	28
ACCESSORY CONNECTIONS	9	SWITCHING POWER ON/OFF	28
EXTERNAL SPEAKER	9	VOLUME ADJUST	28
MICROPHONE	9	SQUELCH ADJUST	28
PACKET EQUIPMENT	9	Noise Squelch	28
Data Connector Pinout	10	S-Meter Squelch	29
YOUR FIRST QSO	11	SQUELCH HANG TIME	29
GETTING ACQUAINTED	12	BAND SELECT	30
FRONT PANEL	12	Selecting AM/FM Mode (TM-251A/E only) ...	31
		VFO MODE	32
		SELECTING FREQUENCIES	32
		Tuning Control	32

Programmable VFO	33	OPERATING THROUGH REPEATERS	48
Microphone [UP]/[DWN] Buttons	34	TRANSMIT OFFSETS	48
FREQUENCY STEP SIZE	35	SELECTING OFFSET DIRECTION	49
Changes in Displayed Frequencies	36	AUTOMATIC TRANSMIT OFFSET	49
TRANSMITTING	37	U.S.A. and Canada Versions	49
MICROPHONE PTT	37	European Versions	50
SELECTING OUTPUT POWER	37	SELECTING OFFSET VALUES MANUALLY ..	50
TIME-OUT TIMER (TOT)	38	REVERSE FUNCTION	51
INHIBITING TRANSMIT	38	TONE ACCESS	51
MEMORY CHANNELS	39	Selecting a Tone Frequency	52
STORING DATA IN MEMORY	39	European Versions	53
Simplex Memory Channels	39	AUTOPATCH	
Split Memory Channels	40	(U.S.A. and Canada Versions)	53
RECALLING MEMORY CHANNELS	41	Activating the Microphone Keypad ..	53
Selecting Channels Sequentially	41	DUAL TONE MULTI-FREQUENCY	
Temporary Frequency Changes	41	(DTMF) MEMORY	54
MEMORY → VFO TRANSFERS	42	Making DTMF Calls	54
ERASING MEMORY CHANNELS	43	Storing DTMF Numbers	54
CALL CHANNEL	43	Confirming Stored DTMF Numbers	55
Recalling Call Channel	43	Transmitting Stored DTMF Numbers	55
Changing Call Channel Contents (Simplex) ..	44	SCAN	56
Changing Call Channel Contents (Split)	45	SCAN RESUME METHODS	57
CHANNEL DISPLAY FUNCTION	45	Time-Operated Scan	57
INITIALIZING MEMORY	46	Carrier-Operated Scan	57
Partial Reset	46	SELECTING SCAN RESUME METHOD	57
Full Reset	46	MEMORY SCAN	58
		Locking-Out Memory Channels	58
		BAND SCAN	59

PROGRAMMABLE BAND SCAN	59	DUAL TONE SQUELCH SYSTEM (DTSS)	75
Setting Scan Limits	59	ACTIVATING DTSS	75
Using Programmable Band Scan	60	STORING DTSS CODES	76
CALL/VFO SCAN	61	DTSS AND REPEATERS	76
CALL/MEMORY SCAN	61	MESSAGE PLAYBACK CONTROL	
AUXILIARY FUNCTIONS	62	VIA DTSS	77
LOCK	62	Setting Message Playback DTSS Code	78
Transceiver Lock	62	PAGE	79
Microphone Lock	62	OVERVIEW	79
AUTOMATIC POWER OFF (APO)	63	PAGE CODE MEMORY	79
BEEP TONE	64	STORING PAGE CODES	79
DISPLAY DIMMER	64	CALLING	81
DISPLAY MODE	65	RECEIVING	82
DISPLAY DEMONSTRATION MODE	66	Receiving a Call with your Station Code	82
REMOTE CONTROL	67	Receiving a Call with a Group Code	82
REMOTE FUNCTIONS USING		PAGE ANSWER-BACK	83
MC-45DM/DME	68	PAGE CODE AND REPEATERS	83
Configuring the PF Keys	70	LOCKING-OUT CODES	84
Monitor Function	70	AUTO PAGE CANCEL	84
REMOTE FUNCTIONS USING TH-7	71	OPEN PAGE	85
KEYPAD DIRECT ENTRY	71	TONE ALERT	86
Frequency Entry	71	ACTIVATING TONE ALERT	86
Memory Channel Entry	73	CHANGING THE ALARM TONE	87
CONTINUOUS TONE CODED SQUELCH SYSTEM		MESSAGE RECORDING	88
(CTCSS)	74	ACTIVATING THE RECORD FUNCTION	88
SELECTING CTCSS FREQUENCIES	74	SELECTING THE RECORDING TIME	88
USING CTCSS	74	SELECTING THE RECORDING MODE	89

PLAYBACK	90
FULL DUPLEX OPERATION	91
PACKET OPERATION	93
ENABLING THE DATA CONNECTOR	93
MAINTENANCE	94
GENERAL INFORMATION	94
SERVICE	94
SERVICE NOTE	95
CLEANING	95
TROUBLESHOOTING	96
OPTIONAL ACCESSORIES	102
INSTALLING OPTIONS	104
OPENING THE TRANSCEIVER	104
INSTALLING THE TSU-8 CTCSS UNIT	104
INSTALLING THE ME-1 EXPANSION MEMORY UNIT	105
SPECIFICATIONS	106
GLOSSARY	108
QUICK REFERENCE GUIDE	115

ACCESSORIES

Accessory	Part Number	Quantity
Transceiver		
U.S.A., Canada, Europe	100-001-000	1
Japan, Finland	100-001-000	1
Power Supply		
U.S.A., Canada, Europe	100-001-000	1
Japan, Finland	100-001-000	1
Antenna		
U.S.A., Canada, Europe	100-001-000	1
Japan, Finland	100-001-000	1
Mounting Bracket		
U.S.A., Canada, Europe	100-001-000	1
Japan, Finland	100-001-000	1
Mounting Plate		
U.S.A., Canada, Europe	100-001-000	1
Japan, Finland	100-001-000	1
Mounting		
U.S.A., Canada, Europe	100-001-000	1
Japan, Finland	100-001-000	1
Mounting		
U.S.A., Canada, Europe	100-001-000	1
Japan, Finland	100-001-000	1
Mounting		
U.S.A., Canada, Europe	100-001-000	1
Japan, Finland	100-001-000	1

FEATURES

- Dual band receive capability on each model in the series:
TM-251A/E: 144 MHz plus 430/440 MHz
TM-451A/E: 430/440 MHz plus 144 MHz
- Full Duplex allows "telephone-style" contacts; Transmit on the Main band with simultaneous Receive on the Sub-band.
- Digital Record extends the convenience of CTCSS, DTSS, Page, and Tone Alert by recording the audio of a station calling you.
- DTSS and Page allow selective calling of specific stations. In addition, combining Tone Alert with Page lets you know who called and when.
- Innovative Menu Set-up method combines sophisticated features with simple operation; ergonomic design places only the most frequently-used keys on the Front Panel without losing desired features.

ACCESSORIES

Accessory	Part Number	Quantity
Microphone U.S.A., Canada, General ¹ Europe, General ¹	T91-0517-XX T91-0516-XX	1 1
DC power cable	E30-2111-XX	1
Fuse TM-251: 15 A TM-451: 10 A	F51-0017-XX F51-0016-XX	1 1
Mounting bracket	J29-0614-XX	1
Stacking plate	J21-4469-XX	1 set
Screws	N99-0384-XX	1 set
Wrench	W01-0426-XX	1
Warranty card (U.S.A., Canada, Europe ²)	—	1
Instruction manual	B62-0455-XX	1

¹ Excluding some General market versions.

² Excluding some European versions.

CONVENTIONS FOLLOWED IN THIS MANUAL

The writing conventions described below have been followed to simplify key stroke instructions and avoid unnecessary repetition. This format is less confusing for the reader. Reviewing the following information now will reduce your learning period. That means less time will be spent reading this manual; more time will be available for operating.

Note: Basic procedures are numbered sequentially to guide you step-by- step. Additional information pertaining to a step, but not essential to complete the procedure, is provided in bulleted form following many steps for further guidance.

INSTRUCTION	MEANING	WHAT TO DO
Press [KEY] .	Press the key.	Press and release KEY .
Press [KEY1] + [KEY2] .	Press the keys simultaneously.	Press and hold KEY1 down, then press KEY2 .
Press [KEY1], [KEY2] .	Press the keys in sequence.	Press KEY1 momentarily, release KEY1 , then press KEY2 .
Press [KEY] + POWER ON .	Press the key while powering the transceiver.	With the transceiver power OFF, press and hold KEY , then turn ON the transceiver power by pressing [PWR] .
Press [F] (1 s) .	Press the Function key for longer than 1 second.	Press and hold the Function key until the "F" indicator on the Display begins flashing.
Press [KEY] (1 s) .	Press the key for longer than 1 second.	Press and hold KEY until the function begins.

PREPARATION FOR MOBILE OPERATION

When operating mobile, do not attempt to configure your transceiver or change Menu settings while driving because it is simply too dangerous. Stop the car first, then make the necessary changes. Also, be aware of local laws pertaining to the use of headphones/headsets while driving on public roads. If in doubt, do not wear headphones while mobiling.

MOBILE INSTALLATION

Install the transceiver in a safe, convenient position inside your vehicle that minimizes danger to your passengers and yourself while the vehicle is in motion. For example, consider installing the transceiver under the dash in front of the passenger seat so that knees or legs will not strike the transceiver during sudden braking of your vehicle. Try to pick a well-ventilated location that is shielded from direct sunlight.



■ Installation Example

- 1 Install the mounting bracket using the supplied flat washers and self-tapping screws. There are 4 washers and 4 screws supplied.
 - The bracket can be mounted with the bracket opening for the transceiver facing down for underdash mounting, or with the opening facing up.
 - If mounted underdash, the bracket must be installed so that the 3 screw holes on the edge of each bracket side are facing forward. This allows you to mount the transceiver horizontally or to angle it upward.
 - If mounted with the bracket opening facing upward, position the bracket with the 3 holes facing forward to angle the transceiver upward. Position the bracket with the 3 holes facing the rear if you plan to angle the transceiver downward. The transceiver can be mounted horizontally, angled neither up nor down, with the bracket positioned either way.

- 2 Position the transceiver in the bracket to determine the best viewing angle.
- 3 Insert and tighten the supplied hexagon SEMS screws and washers. There are 2 screws and 2 washers supplied for each side of the bracket.
 - Double check that all hardware is tightened to prevent vehicle vibration from loosening the bracket or transceiver.

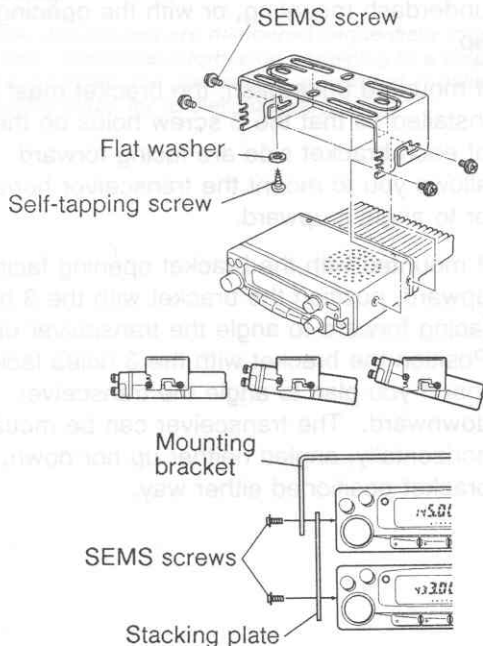

DC POWER CABLE CONNECTION

Route the DC power cable supplied with the transceiver, or an optional DC cable equipped with a noise filter, directly to the vehicle's battery terminals using the shortest path from the transceiver. If using a noise filter, it should be installed with an insulator to prevent it from touching metal on the vehicle. It is not recommended to use the cigarette lighter socket since some cigarette lighter sockets introduce an unacceptable voltage drop.

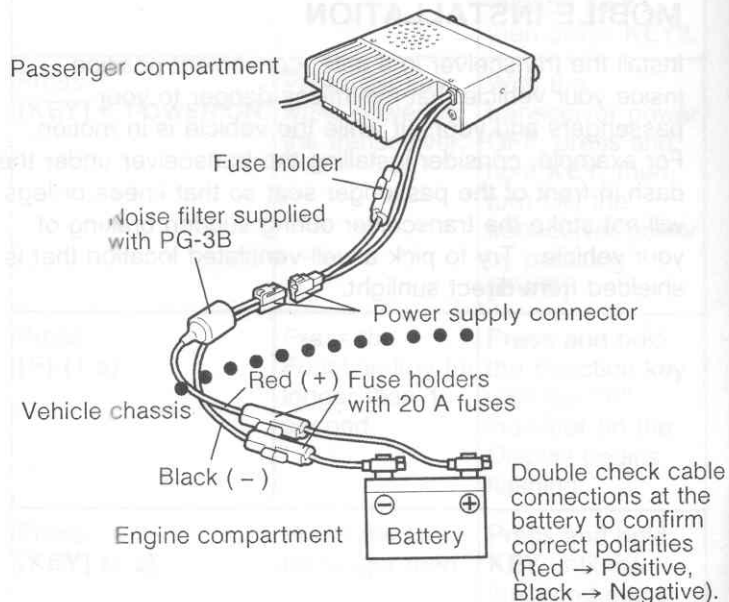

Dismantle fuse holder.

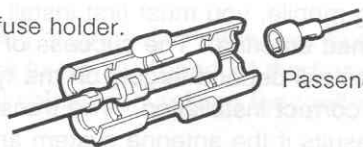

Passenger compartment

To prevent the risk of short circuits, disconnect other wiring from the negative (–) battery terminal before connecting the transceiver. Confirm the correct polarity of the connections before attaching the power cable; red connects to the positive (+) terminal, black connects to the negative (–) terminal. Use the full length of the cable without cutting off excess even if the cable is longer than required. In particular, never remove the fuse holders from the cable. After completing transceiver connections to the battery, then reconnect any wiring removed from the negative terminal.

If the power cable must be routed through a hole in the vehicle chassis or body, for example in the firewall at the front of the passenger compartment, use a rubber grommet to protect the cable from abrasion. The entire length of the cable must be dressed so it is isolated from heat and moisture. After the cable is in place, wind heat-resistant tape around the fuse holder to protect it from moisture. Tie down the full run of cable.

The vehicle battery must have a nominal rating of 12 V. Never connect the transceiver to a 24 V battery. Be sure to use a 12 V vehicle battery that has sufficient current capacity. If the current to the transceiver is insufficient, the Display may darken during transmission, or transmit output power may drop excessively.

Only after completing the installation, connect the transceiver's power supply connector to the DC power cable. Press the connectors firmly together until the locking tab clicks.

■ Replacing Fuses

If the fuse blows, determine the cause then correct the problem. After the problem is resolved, then replace the fuse. If newly installed fuses continue to blow, disconnect the power cable and contact your dealer or nearest Service Center for assistance.

Fuse Location	Fuse Current Rating
TM-251A/E	15 A
TM-451A/E	10 A
Supplied Accessory DC Power Cable	20 A

CAUTION: Only use fuses of the specified type and rating.

Note: If you use the transceiver for a long period when the vehicle battery has not been fully charged, or when the engine has been stopped, the battery may become discharged, and will not have sufficient reserves to start the vehicle. Avoid using the transceiver under these conditions.

ANTENNA CONNECTION

Before operating mobile, you must first install an efficient, well-tuned antenna. The success of your mobile installation will depend largely on the type of antenna and its correct installation. The transceiver can give excellent results if the antenna system and its installation is given careful attention.

Your choice of antenna should have a 50 ohm impedance to match the transceiver input impedance. Use low-loss coaxial feed line that also has a characteristic impedance of 50 ohms. Coupling the antenna to the transceiver via feed lines having an impedance other than 50 ohms reduces the efficiency of the antenna system, and can cause interference to nearby broadcast television receivers, radio receivers, and other electronic equipment.

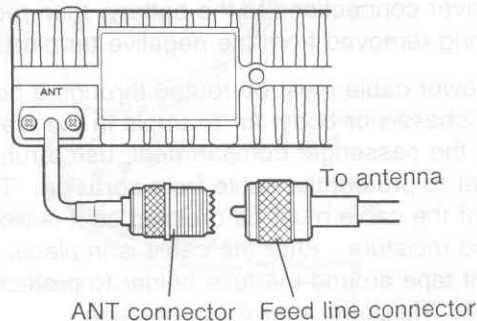

CAUTION: Transmitting without first connecting an antenna or other matched load may damage the transceiver. Always connect the antenna to the transceiver before transmitting.

PREPARATION FOR FIXED STATION OPERATION

The following diagram illustrates how to make connections to the rear panel of the transceiver. Connect all cables securely so they will not come loose if pulled.

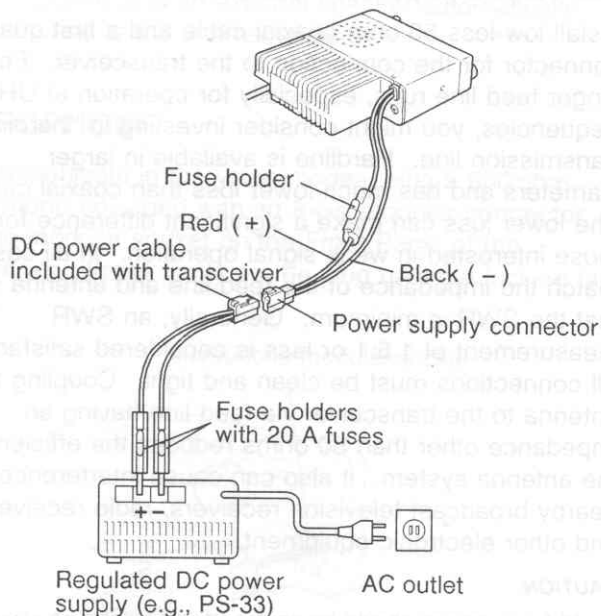

DC POWER SUPPLY CONNECTION

In order to use this transceiver for fixed station operation, you will need a separate 13.8 V DC power supply that must be purchased separately. DO NOT directly connect the transceiver to an AC outlet! Use the supplied DC power cable to connect the transceiver to a regulated power supply. Do not substitute a cable with smaller gauge wires.

The following table lists the current capacity recommended for power supplies used with each type of transceiver.

Transceiver Model	Power Supply Capacity
TM-251A/E	11 A or more
TM-451A/E	10 A or more

First connect the DC power cable to the regulated DC power supply and check that polarities are correct (Red: positive, Black: negative). Then connect the transceiver's DC power connector to the connector on the DC power cable. Press the connectors firmly together until the locking tab clicks.

Note:

- ▶ For your transceiver to fully exhibit its performance capabilities, the following optional power supply is recommended: PS-33 (20.5 A, 25% duty cycle).
- ▶ Before connecting the DC power supply to the transceiver, be sure to switch the transceiver and the DC power supply off.
- ▶ Do not plug the DC power supply into an AC outlet until you make all connections.

■ Replacing Fuses

If the fuse blows, determine the cause then correct the problem. After the problem is resolved, only then replace the fuse. If newly installed fuses continue to blow, disconnect the power plug and contact your dealer or nearest Service Center for assistance.

Fuse Location	Fuse Current Rating
TM-251A/E	15 A
TM-451A/E	10 A
Supplied Accessory DC Power Cable	20 A

CAUTION: Only use fuses of the specified type and rating.

ANTENNA CONNECTION

The type of the antenna system, consisting of the antenna, ground, and feed line, will greatly affect the successful performance of the transceiver. Use a properly adjusted 50 ohm antenna of good quality designed for operation at your operating frequency to let your transceiver perform at its best.

Install low-loss 50 ohm coaxial cable and a first quality connector for the connection to the transceiver. For longer feed line runs, especially for operation at UHF frequencies, you might consider investing in "hardline" transmission line. Hardline is available in larger diameters and has much lower loss than coaxial cable. The lower loss can make a significant difference for those interested in weak signal operation. In all cases, match the impedance of the feed line and antenna so that the SWR is minimum. Generally, an SWR measurement of 1.5:1 or less is considered satisfactory. All connections must be clean and tight. Coupling the antenna to the transceiver via feed line having an impedance other than 50 ohms reduces the efficiency of the antenna system. It also can cause interference to nearby broadcast television receivers, radio receivers, and other electronic equipment.

CAUTION:

- ▶ All fixed stations should be equipped with a lightning arrester to reduce the risk of fire, electric shock, and transceiver damage.
- ▶ Transmitting without first connecting an antenna or other matched load may damage the transceiver. Always connect the antenna to the transceiver before transmitting.

ACCESSORY CONNECTIONS

EXTERNAL SPEAKER

Use an external speaker with 8 ohms impedance. The jack accepts a 3.5 mm diameter mono (2-conductor) plug. Recommended speakers include the SP-50B and SP-41. Connecting an external speaker automatically cuts off audio to the internal speaker.

MICROPHONE

To communicate in the voice modes, plug a 600 ohm microphone equipped with an 8-pin modular connector into the modular socket on the Front Panel of the transceiver. Press firmly on the plug until the locking tab clicks.

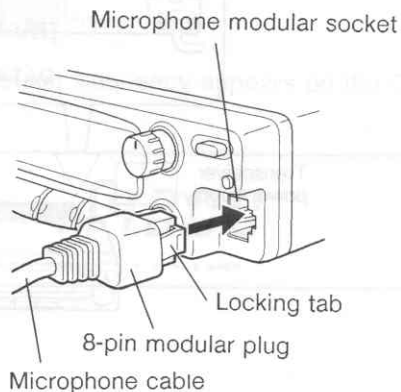

PACKET EQUIPMENT

If you intend to use this transceiver for Packet operation, you will need the following equipment:

- Personal computer with communications software (Alternatively, a "dumb" terminal capable of sending ASCII commands)
- TNC (Terminal Node Controller)
- TNC power supply
- RS-232C cable
- 6-pin mini DIN plug (PG-5A)

Refer to the accompanying diagram and the associated instruction manuals to configure the equipment as shown. Connect your TNC to the DATA connector on the transceiver Rear Panel using a cable equipped with a 6-pin mini DIN plug. Do not share a single power supply between the transceiver and the TNC. Keep as wide a separation between the transceiver and computer as practical to reduce noise-pickup by the transceiver.

■ DATA Connector Pinout

Pin Number	Pin Name	Function
1	PKD	Packet data input • Transmit data from TNC to transceiver
2	DE	Ground for PKD
3	PKS	Packet standby • TNC can use this pin to inhibit the transceiver microphone input while transmitting packet signals.
4	9600D	Detects 9600 bps data.
5	1200D	Detects 1200 bps data.
6	SQC	Squelch control output • Inhibits TNC data transmit while transceiver squelch is open.

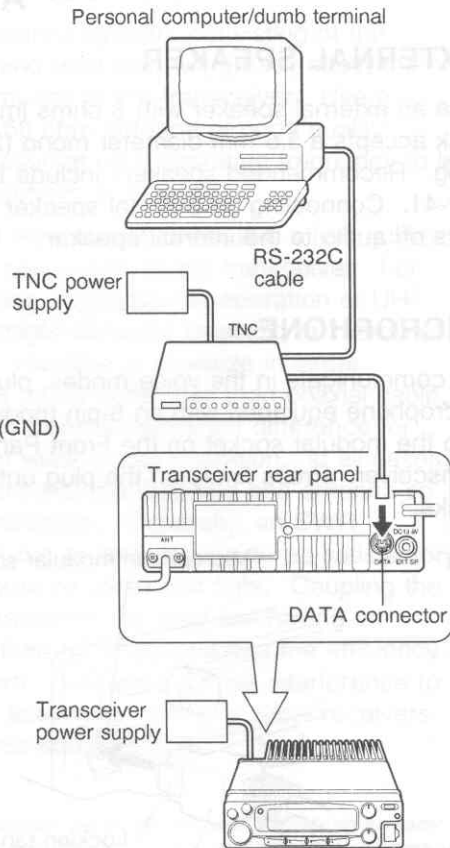
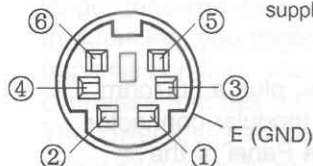

GETTING ACQUAINTED

The following sections describe basic functions of the Front Panel controls and buttons, Rear Panel jacks and connectors, microphone buttons and Display indicators. For full explanations of functions mentioned, refer to the appropriate section elsewhere in the manual.

FRONT PANEL

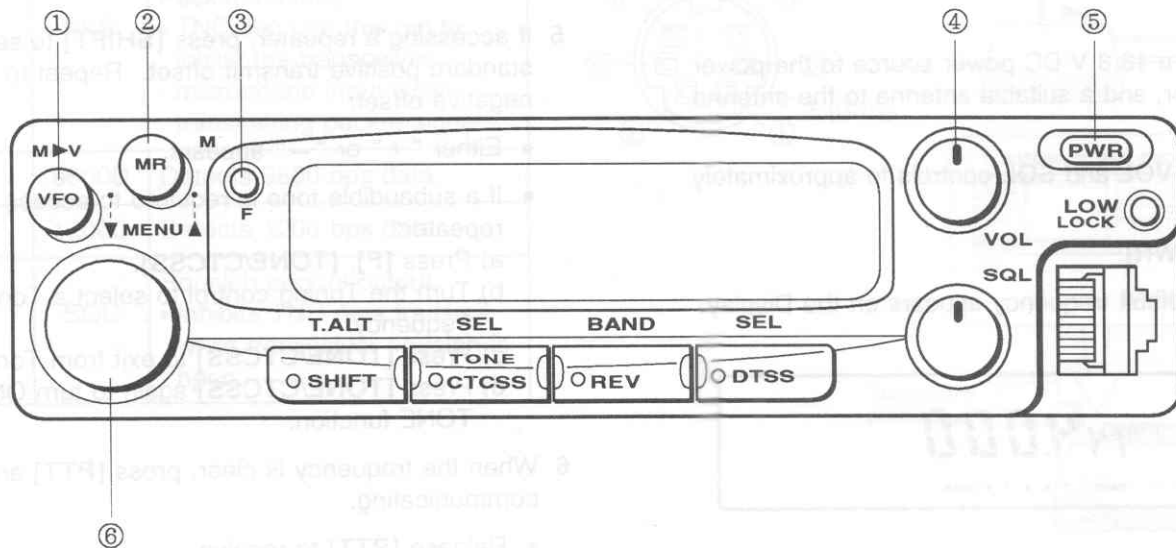

YOUR FIRST QSO

If you tend to discard instruction manuals along with the packaging material....please don't. The 5 steps below will get you on the air in your first QSO within minutes to allow you to experience the exhilaration that comes with opening a brand new transceiver.

After trying the rig for a while, settle back in your most comfortable operating chair with this manual and your favorite drink for an hour or two. The time spent will be worthwhile.

- 1 Connect a 13.8 V DC power source to the power connector, and a suitable antenna to the antenna connector.
- 2 Turn the **VOL** and **SQL** controls to approximately 9 o'clock.
- 3 Press **[PWR]**.
 - The default frequency appears on the Display.



- 4 Turn the Tuning control to select a frequency.



- 5 If accessing a repeater, press **[SHIFT]** to select a standard positive transmit offset. Repeat to select a negative offset.
 - Either "+" or "-" appears.
 - If a subaudible tone is required to access the repeater:
 - a) Press **[F]**, **[TONE/CTCSS]**.
 - b) Turn the Tuning control to select a Tone frequency.
 - c) Press **[TONE/CTCSS]** to exit from Tone Select.
 - d) Press **[TONE/CTCSS]** again to turn ON the TONE function.
- 6 When the frequency is clear, press **[PTT]** and begin communicating.
 - Release **[PTT]** to receive.

① VFO button

Provides the following 5 functions:

- VFO mode select {page 32}
- Menu function select (descending order) {page 22}
- VFO Scan {page 59}
- Memory/Call channel transfer to VFO {page 42}
- Partial reset {page 46}

② MR (Memory Recall) button

Provides the following 5 functions:

- Memory Recall select {page 41}
- Menu function select (ascending order) {page 22}
- Memory Scan {page 58}
- Memory Write {page 39}
- Full reset {page 46}

③ F (Function) button

Provides the following 3 functions:

- Multiple key function select
- Menu Set-up enter {page 22}
- Menu Set-up exit {page 22}

④ VOL (Volume) control

Adjusts the level of receive audio from the speaker {page 28}.

⑤ PWR (Power) switch

Switches the transceiver ON or OFF {page 28}. Also used in conjunction with other keys to access Menu B {page 24} or initialize the microprocessor and its memory {page 46}.

⑥ TUNING control

Provides the following 6 functions:

- Selects transmit/receive frequencies {page 32} and frequency limits {pages 33 and 59}.
- Selects memory channels in Memory Recall {page 41}.
- Selects available choices when configuring Menu functions {page 22}.
- Selects subaudible Tone frequency {page 52} and transmit offset {page 50}.
- Selects scan direction {page 58}.
- Selects DTSS/page codes {pages 76 and 79}.

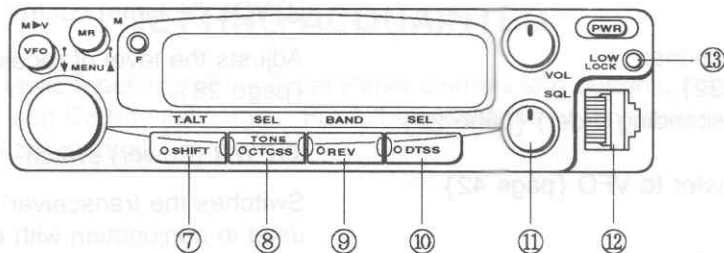

⑦ SHIFT button

Selects the transmit frequency offset with respect to the receive frequency {page 49}. Also toggles Tone Alert ON or OFF {page 86}.

⑧ TONE/CTCSS button

Switches Tone and CTCSS ON or OFF {pages 51 and 74}. Also used for selecting the subaudible Tone frequency {page 52}.

⑨ REV (Reverse) button

Switches the transmit frequency and receive frequency when operating with a transmit offset or split frequency {page 51}. Also toggles the transceiver between the Main band or the Sub-band {page 30}.

⑩ DTSS button

Toggles DTSS and Page ON or OFF. Also used for setting the DTSS code and Page codes {page 75}.

⑪ SQL (Squelch) control

Adjusts the squelch threshold level {page 28}. This allows you to mute speaker output while no stations are being received.

⑫ Microphone connector

Insert the 8-pin modular microphone plug until the locking tab "clicks".



⑬ LOW button

Selects High, Mid, or Low transmit output power. Also activates Lock {page 62} and memory channel lock-out {page 58} functions.

REAR PANEL

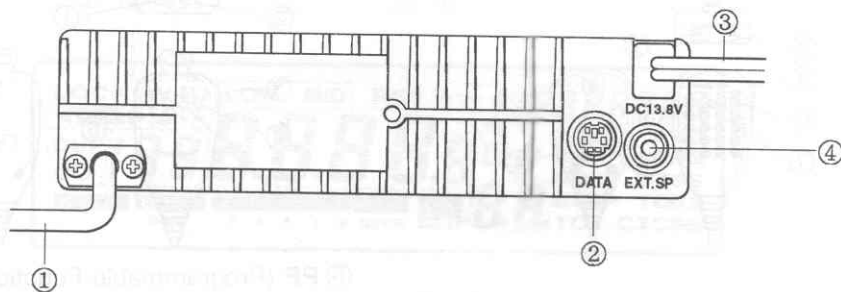

① ANT connector

Connect an external antenna designed for operation on the same band as this transceiver. When making test transmissions, connect a dummy load in place of the antenna. The antenna system or load should have an impedance of 50 ohms. All models accept a male PL-259 coaxial plug except the TM-451E which accepts a male Type N plug.

② DATA connector

Connect a Terminal Node Controller (TNC) for Packet operation. Accepts a 6-pin mini DIN plug. See page 10 for pinout details.

③ Power Input DC 13.8 V connector

Connect a 13.8 V DC power source. Use the supplied DC power cable.

④ EXT. SP jack

Connect an optional external speaker for clearer audio. Accepts a 3.5 mm diameter (2-conductor) plug.

MICROPHONE

MC-45DM/45DME

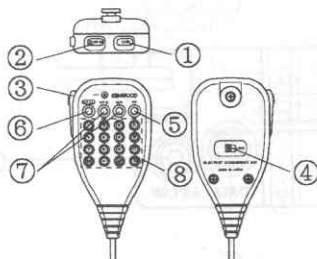

MC-45/45E

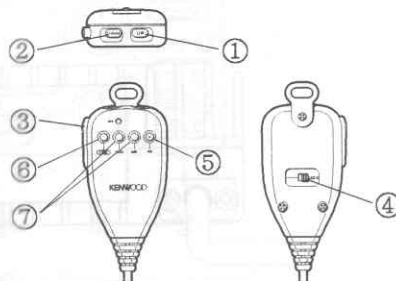

① **UP** button

② **DWN** button

Raises or lowers the VFO frequency, the memory channel number, the Tone/CTCSS frequency, the DTSS/Page code, or the Page memory number. Holding either button down causes the action to be repeated, and "fuzzy" logic increases the rate of repetition with time. Also, in Menu Set-up, switches among available menu selections for each menu function.

③ **PTT** (Push-to-talk) switch

Press to transmit; release to receive. Also, press to exit Scan and Menu Set-up functions, DTSS/Page code setting, or Tone/CTCSS frequency setting.

④ **LOCK** switch

Locks all microphone functions except **[PTT]** and the DTMF keypad, if equipped.

⑤ **PF** (Programmable Function) key

Activates the Monitor function to open and close the squelch regardless which squelch system is being used. The key function can be re-programmed, if desired {page 70}. On European versions, activates the 1750 Hz tone for repeater access.

⑥ **CALL** key, **1750** key

Recalls the Call channel. Pressing for more than 1 second initiates a Call Scan. The Call function can be re-programmed, if desired {page 70}. On European versions, sends a 1750 Hz tone for repeater access.

⑦ **VFO** key, **MR** key

Identical to the Front Panel functions of the same name. Both functions can be re-programmed, if desired {page 70}.

⑧ **DTMF keypad** (some versions only)

The 16-key keypad is used to transmit DTMF tones.

DISPLAY

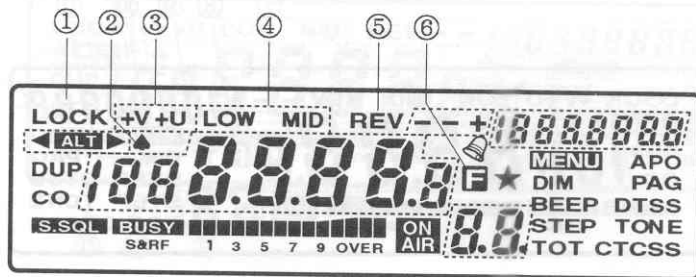

① LOCK

Indicates the Lock function is ON; most Front Panel and microphone buttons and keys are locked {page 62}.

② ▲

Indicates AM receive mode is ON. Blinks while accessing Menu A, AM/FM Mode {page 23}. AM/FM mode is available only on some versions of the TM- 251A/E {page 31}.

③ +V +U

Indicates the 144 MHz Sub-band (" +V") or 430/440 MHz Sub-band (" +U") is selected {page 30}.

④ LOW, MID

Indicates Low or Mid transmit output power is selected {page 37}. When "LOW" or "MID" are not visible, High output power is selected.

⑤ REV

Indicates the Reverse function is ON {page 51}. Transmit and receive frequencies are reversed.

⑥ F

Appears when [F] is pressed. Indicates that alternate functions of multiple-function buttons can be accessed now.

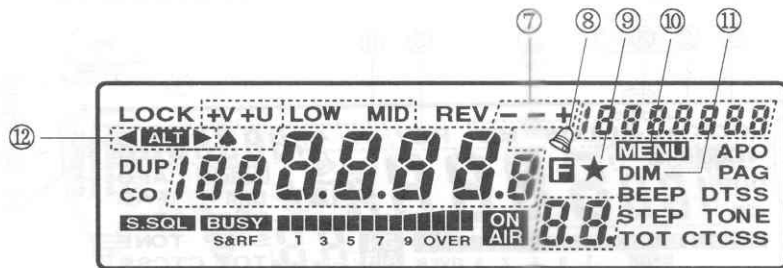

⑦ - - +

Indicates the transmit frequency is offset (different) from the receive frequency {page 49}. The symbol displayed indicates the direction that the transmit frequency is offset from the receive frequency. Also indicates a split-frequency memory channel is selected {page 41}. "- +" blinks while Menu A, Transmit Offset is selected {page 23}.

⑧

Indicates Tone Alert is ON {page 86}. When using Tone Alert, blinks after receipt of a signal. Also blinks while Menu A, Tone Alert Alarm Tone is selected {page 23}.

⑨ ★

Indicates the selected memory channel is locked-out {page 58}.

⑩ **MENU**

Blinks while accessing Menu A {page 23}. Remains ON while accessing Menu B {page 24}.

⑪ **DIM**

Blinks when selecting the level of Display illumination in Menu A, Display Brightness {page 23}.

⑫

This indicator is not currently used.

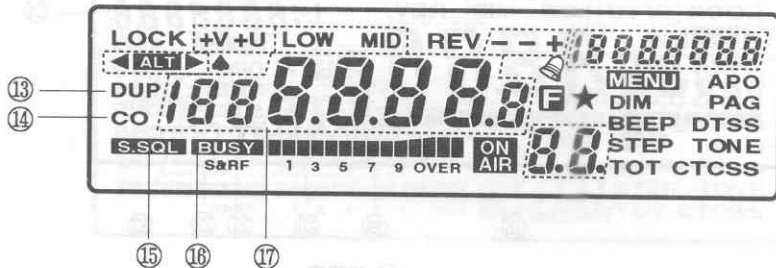

13 DUP

Indicates Full Duplex mode is ON {page 91}. Blinks while accessing Menu A, Full Duplex {page 23}.

14 CO

Indicates Carrier-operated Scan Resume is ON {page 57}. When not visible, Time-operated Scan Resume is in effect. Blinks while accessing Menu A, Scan Resume {page 23}.

15 S.SQL

Indicates S-meter squelch is ON {page 29}. Blinks while accessing Menu A, S-meter Squelch {page 23}.

16 BUSY

Indicates the squelch is open due to a receive signal or noise that is greater in strength than the noise squelch threshold level {page 28}. Also appears when the noise squelch is set to minimum by turning the **SQL** control fully counterclockwise. If using either CTCSS or DTSS, indicates the squelch is open due to a received signal that contains a CTCSS tone or DTSS code that matches the tone or code programmed in your transceiver.

17 1888.888.8

Displays the transmit/receive frequency, frequency step {page 35}, and Tone frequency {page 52}. Also displays the available selections when using Menu Set-up {page 22}. The decimal point blinks while the transceiver is scanning {page 59}.

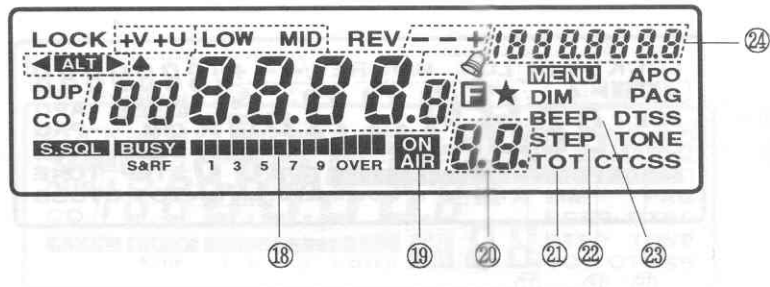

In Receive, acts as an S-meter to indicate the signal strength of received signals. In Transmit, acts as an RF power meter to indicate the relative transmit output power {page 37}. Full scale represents High transmit power.



Indicates the transceiver is in Transmit mode with a transmit frequency that is within the transmit band.



Displays the currently selected memory channel number {page 41} or Menu B number {page 24}. The dots beside the memory channel numbers are used only by the ME-1 Expansion Unit. The right dot appears when the 100s digit of the channel number is 1 (memory channels 100-199). The left dot appears when the 100s digit of the channel number is 2 (memory channel 200).



Indicates the Time-out Timer is ON {page 38}. Blinks while accessing Menu A, Time-Out Timer {page 23}.



Blinks while accessing Menu A, Frequency Step {page 23}.



Blinks while accessing Menu A, Confirmation Beep {page 23}.



Acts as a Sub-display to show receive frequency, Tone frequency, etc.



25 APO

Indicates Automatic Power Off is ON {page 63}. Blinks while accessing Menu A, Automatic Power Off {page 23}.

26 PAG

Indicates Page is ON {page 79}.

27 DTSS

Indicates the Dual Tone Squelch System is ON {page 75}.

28 TONE

Indicates the subaudible Tone encoder is ON {page 52}.

29 CTCSS

Indicates the Continuous Tone Coded Squelch System is ON when the CTCSS option (TSU-8) is installed {page 74}.

MENU SET-UP

MENU DESCRIPTION

Many functions on this transceiver are selected or configured via software-controlled menus instead of physical controls on the transceiver. Once familiar with the Menu system, you will appreciate the versatility it offers. No longer is the number and complexity of features restricted by the physical size of transceiver.

The Menus are identified as Menu A and Menu B. Menu A is used to access functions that are frequently changed while Menu B is used for less frequently changed functions.

MENU A ACCESS



Anytime that you want to change a function that is controlled by Menu A, use the following procedure:

- 1 Press **[F]** (1 s) to enter Menu A.
 - "MENU" begins blinking and the menu selected last appears.
- 2 Select the desired menu function by pressing either **[MR]** or **[VFO]**.

- Press **[VFO]** to cycle through functions in a downward direction on the chart.
 - Press **[MR]** to cycle through functions in an upward direction on the chart.
 - Microphone **[MR]** or **[VFO]** may be used if more convenient.
- 3 Select the desired menu selection by turning the Tuning control or by pressing microphone **[UP]** or **[DWN]**.
 - When selecting from a group of numeric menu selections, turning the Tuning control clockwise or pressing microphone **[UP]** selects in ascending order, and turning the Tuning control counterclockwise or pressing microphone **[DWN]** selects in descending order.
 - 4 After selecting the desired menu selection, press **[SHIFT]** or **[TONE/CTCSS]** or **[REV]** or **[DTSS]** to exit Menu A.

Note: The Automatic Power Off timer stops counting while you are in Menu Set-up.

MENU A CONFIGURATION

Menu Label	Description	Selections	Default	Page
DIM	Display Brightness ● 5 illumination levels (d1: brightest)	OFF/d4/d3/d2/d1	d2	64
BEEP	Confirmation Beep	OFF/ON	ON	64
STEP	Frequency Step Size	12.5kHz/25kHz/5kHz/ 10kHz/15kHz/20kHz	TM-251A/E: 12.5 kHz ¹ TM-451A/E: 25 kHz	35
TOT	Time-Out Timer	OFF/3/5/10/20/30 minutes	OFF	38
APO	Automatic Power Off	OFF/60/120/180 minutes	OFF	63
DUP	Full Duplex	OFF/ON	OFF	91
CO	Scan Resume	TO/CO	TO	57
S.SQL	S-meter Squelch	OFF/ON	OFF	29
+ -	Transmit Offset (Shift)	d, 5 kHz to 40 MHz	d ²	50
	Tone Alert Alarm Tone	Bel1/Bel2/Bel3	Bel1	87
	Display Mode during CTCSS, DTSS, or Page	OFF/Sub1/Sub2	OFF	65
	AM/FM Mode ³	A/F	FM (AM: 118 to 136 MHz)	31

¹ TM-251A (U.S.A. and Canada): 5 kHz

² TM-251A/E: 600 kHz, TM-451A: 5 MHz, TM-451E: 1.6 MHz

³ Only on Main Band of TM-251A/E with expanded receive coverage outside the Amateur bands.

MENU B ACCESS

Anytime that you want to change a function that is controlled by Menu B, use the following procedure:

- 1 Press **[REV] + POWER ON** to enter Menu B.
 - The menu and menu number selected last appears.
- 2 Select the desired menu function by pressing either **[MR]** or **[VFO]**.
 - Press **[MR]** to increment Menu No., and **[VFO]** to decrement Menu No.
 - Microphone **[MR]** or **[VFO]** may be used if more convenient.

- 3 Select the desired menu selection by turning the Tuning control or by pressing microphone **[UP]** or **[DWN]**.
 - When selecting from a group of numeric menu selections, turning the Tuning control clockwise or pressing microphone **[UP]** selects in ascending order, and turning the Tuning control counterclockwise or microphone **[DWN]** selects in descending order.
- 4 After selecting the desired menu selection, press **[SHIFT]** or **[TONE/CTCSS]** or **[REV]** or **[DTSS]** to exit Menu B.

MENU B CONFIGURATION

Menu No	Description	Selections	Default	Page
50	Remote Control Mode	OFF/ON	OFF	67
51	Automatic Page Cancel	OFF/ON	OFF	84
52	Open Page	OFF/ON	OFF	85
53	DTSS/Page Transmit Delay Time (offset/split only)	350ms/550ms	350 ms	76,83
54	Transmit Hold for 1750 Hz Tone <ul style="list-style-type: none">• TM-251E/TM-451E only	OFF/ON	OFF	53
55	Transmit Inhibit	OFF/ON	OFF	38
56	Frequency Change during Memory Recall	OFF/ON	OFF	41
57	DATA Connector Baud Rate	1200/9600	1200	93

Menu No	Description	Selections	Default	Page
58	Microphone Connector Receive Audio ● Audio available from RD terminal while squelch is open.	OFF/ON	ON	71
59	Channel Display ● Frequency Display (OFF) or Channel Number Display (ON)	OFF/ON	OFF	45
60	Programmable Band Scan (Lower Limit)	Receive Frequencies	—	59
61	Programmable Band Scan (Upper Limit)	Receive Frequencies	—	59
62	Programmable VFO Tuning (Lower Limit)	Receive Frequencies	Lowest Receive Frequency	33
63	Programmable VFO Tuning (Upper Limit)	Receive Frequencies	Highest Receive Frequency	33
64	Squelch Hang Time Select	OFF/125/250/500	OFF	29
65	DTMF Memory Store	OFF/P ---	OFF	54
66	Record Timer Select	8 sec/16 sec	8 sec	88
67	Record Mode ● Continuous (1) or Single (2)	1/2	1	89
68-70	Unsupported Functions	—	—	—
71	Page Answer-back	OFF/ON	OFF	83
72	Message Playback Control via DTSS	OFF/ON	OFF	77
73	DTSS Code Select for Message Playback	000-999	919	78

CONFIRMATION BEFORE OPERATION

Before proceeding, run through the following checklist to double check that your transceiver is ready to operate:

REAR PANEL

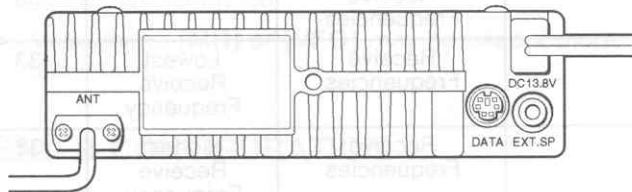

ANT (Antenna)

- Is the correct antenna actually connected?
- Is a lightning protector installed for a fixed station?
- Are interconnecting coaxial cables between the transceiver, accessory station equipment and the antenna connected?
- Are all cable connectors well-installed (including no cold solder joints?) and screwed tight?
- Are coax switches set for the correct antenna?

CAUTION: DO NOT transmit without connecting an antenna or dummy load to the ANT connector. The transceiver can fail.

DC 13.8 V (DC Power Cable)

- Is the power cable connected and locked in place?
(Do not turn on the transceiver or DC power supply yet.)

DATA Connector

- Is a TNC connected correctly for Packet operation?

FRONT PANEL

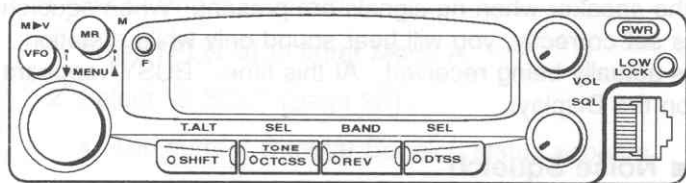

Controls

- Are they preset as shown in the diagram?

Microphone

- Is a recommended microphone installed?



SWITCHING POWER ON/OFF

Switch ON the DC power supply, then press [PWR] to switch ON the transceiver.

- If operating mobile, simply press [PWR] on the transceiver.
- After the "- on -" message, the frequency and possibly other indicators appear on the Display.

To switch OFF the transceiver, press [PWR] again.

In a fixed installation, after the transceiver has been switched ON, it can then be switched OFF or ON by using only the power switch on the DC power supply.

VOLUME ADJUST

Turn the VOL control clockwise to increase the audio level, and counterclockwise to decrease the level.

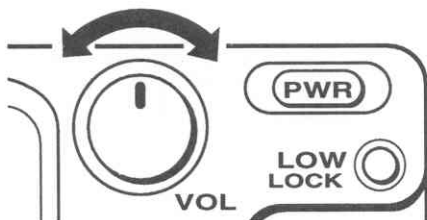

SQUELCH ADJUST

The purpose of squelch is to silence audio output from the speaker when no signals are present. When squelch is set correctly, you will hear sound only while a station is actually being received. At this time, "BUSY" appears on the Display.

■ Noise Squelch

Turn the SQL control clockwise to just eliminate the background noise when no signal is present.

The point at which ambient noise on a frequency just disappears, called the squelch threshold, depends on the frequency. Setting the squelch threshold too high causes squelch to remain closed while a weak signal is present. The station will not be heard. You may mistakenly think your transceiver's receive sensitivity is low or you have an audio problem.* Setting the threshold too low allows noise to be heard between transmissions from other stations.



■ S-Meter Squelch

By activating S-meter Squelch, you can set the squelch threshold so the squelch does not open until a signal with the same or greater strength than the S-meter setting is received.

- 1 Press **[F]** (1 s) to enter Menu A.
- 2 Select "S.SQL" {page 22}.
 - The current S-meter Squelch status appears.



- 3 Select a squelch status.
 - OFF: Disables S-meter Squelch.
 - ON: Enables S-meter Squelch.
 - Default: OFF
- 4 Exit Menu A.
 - "S.SQL" remains ON.
- 5 After switching S-meter Squelch ON, adjust the SQL control to set the S-meter for the minimum signal strength that you want to open the squelch.

SQUELCH HANG TIME

When using S-meter Squelch, you may want to adjust the Hang Time (time for the squelch to close after the received carrier drops).

- 1 Press **[REV]** + **POWER ON** to enter Menu B.
- 2 Select Menu No. 64 {page 24}.
 - The current Hang Time value appears.



- 3 Select a value.
 - The available selections are OFF, 125, 250, 500 ms.
 - Default: OFF.
- 4 Exit Menu B.

BAND SELECT

The transceiver is equipped with a Main Band for both transmitting and receiving, plus a Sub-band for receiving only. When the Sub-band is selected, [PTT] is disabled, although [TONE/CTCSS] and [REV] are still functional. Full Duplex communication is possible by taking advantage of the receive capability of the Sub-band. See page 91 for more information on Full Duplex operating.

¹ Expanded receive coverage: 118 to 174 MHz

² Expanded receive coverage: 300 to 470 MHz

³ Some versions include expanded receive coverage: 118 to 174 MHz

⁴ Some versions include expanded receive coverage: 300 to 470 MHz

⁵ Expanded receive coverage: 136 to 174 MHz

⁶ Some versions include expanded receive coverage from 136 to 174 MHz. Some versions include an expansion band that covers 800 to 1000 MHz.

Version	TM-251	
	Main Band	Sub-Band
Canada U.S.A.	144 MHz ¹	440 MHz ²
Europe General	144 MHz ³	430 MHz ⁴

Version	TM-451	
	Main Band	Sub-Band
Canada U.S.A.	440 MHz ²	144 MHz ⁵
Europe General	430 MHz ⁴	144 MHz ⁶

Select the Main Band or Sub-band by pressing [F], [REV].

- When the Sub-band is selected, " + U" or " + V" appears as a reminder that the UHF or the VHF Sub-band is currently selected.
- After switching bands, the frequency used last on the new band and the frequency step stored in Menu A for the new band are selected automatically.
- Each time the above button combination is entered, the transceiver toggles between the Main Band and Sub-band.

Note: The 800 MHz expansion band on European and General versions is selected in the same way as the Sub-band by pressing [F], [REV].

■ Selecting AM/FM Mode (TM-251A/E only)

The U.S.A. and Canada versions of TM-251A, plus some versions of TM-251A (General) and TM-251E are able to receive AM and FM modes on the Main Band. The AM mode is selected automatically when any frequency in the range 118.000 to 135.995 MHz (AIR band) is chosen. Outside this range, the default is FM, but AM can be selected manually via Menu A. Changing bands after manually selecting AM or FM mode causes the default mode to be restored automatically.

- 1 Select the Main Band by pressing [F], [REV].
 - AM/FM selection is only possible on the Main Band.
- 2 Press [F] (1 s) to enter Menu A.
- 3 Select "Spade" {page 22}.
 - "Spade" begins blinking and the current AM/FM selection appears.



- 4 Select a mode.
 - The available selections are AM or FM.
 - Default : 118.000 to 135.995 MHz : AM
All other frequencies : FM
- 5 Exit Menu A.
 - "Spade" remains ON if the AM mode was selected.
 - When AM is selected outside the AIR band, "Spade" disappears while transmitting since FM is used for transmissions.

VFO MODE

The VFO mode allows you to select operating frequencies by using the Tuning control or the microphone as explained under "SELECTING FREQUENCIES" below.

Press **[VFO]** to select VFO mode.

- The currently selected frequency appears.
- If already in VFO mode, there is no change.

VFO mode must be selected when using the following functions:

Select VFO mode to use:	Page Ref.	Select VFO mode to use:	Page Ref.
Programmable Band Scan Limit Select	59	Programmable VFO Limit Select	33

SELECTING FREQUENCIES

■ Tuning Control

Using the Tuning control is convenient when you are within easy reach of the transceiver Front Panel, and the frequencies to be selected lie near the current frequency. The "fuzzy logic" design temporarily increases the frequency step size as the Tuning control is turned more rapidly.

- 1 Press **[VFO]** to select VFO mode.
- 2 Select your desired band by pressing **[F]**, **[REV]**.
- 3 Turn the Tuning control to select a receive frequency.
 - Clockwise rotation increases the frequency one frequency step at a time.
 - Counterclockwise rotation decreases the frequency one frequency step at a time.

If you cannot select a particular receive frequency, the frequency step size needs to be changed. See "FREQUENCY STEP SIZE" {page 35} for further information.

Note: Frequencies can also be selected via the microphone keypad. See "KEYPAD DIRECT ENTRY" {page 71}.

■ Programmable VFO

You may want to set limits for the minimum and maximum frequencies that are selectable with the Tuning control, for example, to keep your operating within the frequencies set aside by band plans for FM operation. The limits can be set or modified at any time, and are configurable for each band on the transceiver.

- 1 Press **[VFO]** to select VFO mode.
- 2 Select the band on which you want to set the VFO limits by pressing **[F]**, **[REV]**.
- 3 Press **[REV] + POWER ON** to enter Menu B, then select Menu No. 63 {page 24}.
 - The current upper limit appears.
 - The default is the maximum frequency that can be selected on your version of transceiver.
- 4 Turn the Tuning control, or press microphone **[UP]** or **[DWN]**, to select the desired upper limit.
 - The 10 kHz and lower digits are fixed according to the frequency step currently selected in Menu A:
5, 10, 15, 20 kHz: 95
12.5, 25 kHz: 87.5
 - The upper limit must be either 87.5 kHz or 95 kHz higher than the lower limit depending on the current frequency step.

- 5 Select Menu B, No. 62.

- The current lower limit appears.
- The default is the minimum frequency that can be selected on your version of transceiver.

- 6 Turn the Tuning control, or press microphone **[UP]** or **[DWN]**, to select the desired lower limit.

- The 10 kHz and lower digits are set to 0.

- 7 Exit Menu B.

Note:

- ▶ *The upper limit is set first above; however, either lower or upper limit may be set first provided the upper limit is placed in Menu B, No. 63 and the lower limit is placed in Menu B, No. 62.*
- ▶ *To reset the limits to their default values, you can do a Partial or Full Reset {page 46}, or manually set the limits to the maximum and minimum frequencies for your version of transceiver.*

■ Microphone [UP]/[DWN] Buttons

Using microphone [UP] or [DWN] for frequency selection is useful when mobilizing or anytime you are not immediately in front of the transceiver.

Press [UP] or [DWN] once to change the receive frequency by one frequency step in the direction indicated by the button.

- Pressing and holding either button causes the frequency to step repeatedly in one direction until the button is released.

FREQUENCY STEP SIZE

Choosing the correct step size when operating is essential in order to select your exact receive frequency with the Tuning control or microphone [UP]/[DWN]. The best step size is the largest step that will still allow you to select all frequencies on which you plan to operate. Using the best step size reduces the time required to select new frequencies; operating becomes easier.

Version	Defaults (kHz)			
	TM-251		TM-451	
	Main	Sub	Main	Sub/Exp. ¹
Canada U.S.A.	5	25	25	5
Europe General	12.5	25	25	12.5

¹ The 800 MHz expansion band is on some European and General versions.

- 1 Press [VFO] to select VFO mode.
 - The step size can only be changed in VFO mode.
- 2 Select the band on which you want to set the frequency step by pressing [F], [REV].
- 3 Press [F] (1 s) to enter Menu A.

- 4 Select "STEP" {page 22}.
 - "STEP" begins blinking and the current frequency step appears.
- 5 Select a step size.
 - The available steps are as follows:

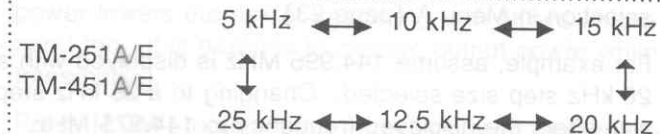

TM-451A/E¹
(800 MHz only) 12.5 kHz ↔ 25 kHz

¹ Some European and General versions only.

- 6 Exit Menu A.

■ Changes in Displayed Frequencies

Changing between step sizes may result in a change of the displayed frequency. When a change occurs, and by how much, is shown in the accompanying charts. This change also affects upper and lower frequency limits selected for the Programmable Band Scan function {page 59} and the transmit offset selection in Menu A {page 23}.

For example, assume 144.995 MHz is displayed with a 20 kHz step size selected. Changing to a 25 kHz step size alters the displayed frequency to 144.975 MHz.

5, 10, 15 or 20 kHz → 12.5 or 25 kHz Step Size Step Size	
Displayed Frequency (10 kHz/ 1 kHz)	Displayed Frequency (10 kHz/ 1 kHz)
00, 05, 10, 15	00
20, 25, 30, 35	25
40, 45, 50, 55	50
60, 65, 70, 75, 80, 85, 90, 95	75

12.5 or 25 kHz → 5, 10, 15 or 20 kHz Step Size Step Size	
Displayed Frequency (10 kHz/ 1 kHz/ 500 Hz)	Displayed Frequency (10 kHz/ 1 kHz)
00	00
12.5	10
25	20
37.5	30
50	50
62.5	60
75	70
87.5	80

TRANSMITTING

MICROPHONE PTT

When ready to begin transmitting, press and hold [PTT] and speak in a normal tone of voice. Speaking too close to the microphone, or too loudly, may increase distortion and reduce intelligibility of your signal at the receiving station.

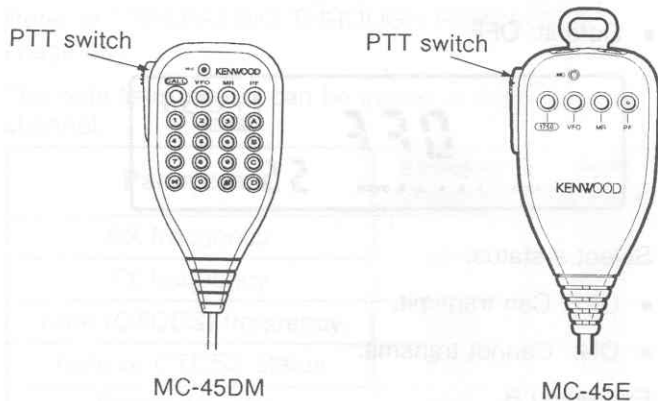

SELECTING OUTPUT POWER

It's wise, and required by law, to select the lowest power that allows reliable communication. If operating from battery power, lower transmit power will give you more operating time before a charge is necessary. Reducing power lowers the risk of interfering with others on the band too. It is possible to change output power while transmitting.

Press [LOW] to select the transmit power you require.

- Default: High power (no indicator visible)
- Each press of [LOW] changes the power as follows:

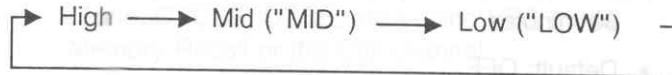

Model	High	Mid	Low
TM-251	50 W	Approx. 10 W	Approx. 5 W
TM-451	35 W	Approx. 10 W	Approx. 5 W

TIME-OUT TIMER (TOT)

It is sometimes necessary or desirable to restrict a single transmission to a specific maximum time. This feature can be useful when accessing repeaters to prevent repeater time-outs, or when particularly trying to conserve battery power. Activate TOT anytime you wish to limit your transmit time.

- 1 Press **[F]** (1 s) to enter Menu A.
 - "TOT" begins blinking and the current TOT selection appears.
- 2 Select "TOT" {page 22}.
 - "TOT" begins blinking and the current TOT selection appears.
- 3 Select a timer value.
 - The available selections are OFF, 3, 5, 10, 20, and 30 minutes.
 - Default: OFF
- 4 Exit Menu A.
 - "TOT" remains ON.

When TOT times out, the transceiver automatically returns to Receive. To resume transmitting, release and then press **[PTT]** again.

INHIBITING TRANSMIT

The transmit function can be disabled to prevent unauthorized individuals from transmitting, or to eliminate the risk of yourself accidentally transmitting.

- 1 Press **[REV]** + **POWER ON** to enter Menu B.
 - The current status of Transmit Inhibit appears.
 - Default: OFF
- 2 Select Menu No. 55 {page 24}.
 - The current status of Transmit Inhibit appears.
 - Default: OFF
- 3 Select a status.
 - OFF: Can transmit.
 - ON: Cannot transmit.
- 4 Exit Menu B.



If **[PTT]** is pressed while Transmit Inhibit is ON, your transceiver beeps and will not transmit.

MEMORY CHANNELS

A total of 40 memory channels (1 to 40) are available for storing frequencies and related data. Each memory channel can be used either as a simplex channel or split channel for storing any frequency or frequency pair that can be selected on the transceiver. Alternatively, a standard or non-standard frequency offset and offset direction required for using repeaters can be stored. Refer to "OPERATING THROUGH REPEATERS" {page 48}.

The data listed below can be stored in each memory channel:

Parameter	Simplex Channel	Split Channel
RX frequency	YES	YES
TX frequency		YES
Tone (CTCSS) frequency	YES	YES
Tone or CTCSS status	YES	YES
Frequency step	YES	YES
Shift status, REV status	YES	N/A
DTSS code, DTSS status	YES	YES

YES: Can be stored in memory.

N/A: Not applicable

Note: The total number of memory channels can be expanded to 200 by installing the ME-1 Expansion Unit option.

STORING DATA IN MEMORY

There are 2 methods of storing transmit/receive frequencies and associated data in memory channels depending on the relationship of the transmit and receive frequencies:

- Simplex memory channels:
RX frequency = TX frequency
- Split memory channels:
RX frequency \neq TX frequency

■ Simplex Memory Channels

- 1 Select the desired frequency and associated data (Tone, CTCSS, DTSS, etc.) using VFO mode, Memory Recall or the Call channel.
- 2 Press [F] to select Memory Storage.
 - "F" and a memory channel number appear.



3 Turn the Tuning control, or press microphone [UP] or [DWN], to select the desired memory channel.

4 Press [MR].

- The selected frequency and associated data are stored in the memory channel. A transmit frequency from a split memory channel or split Call channel is not stored.
- If the memory channel selected in the previous step already contained data, the new data overwrites the previous data.
- The previous mode is restored.



■ Split Memory Channels

- 1 Select the desired receive frequency and associated data (Tone, CTCSS, DTSS, etc.) using VFO mode, Memory Recall or the Call channel.
- 2 Press [F] to select Memory Storage.
 - "F" and a memory channel number appear.
- 3 Turn the Tuning control, or press microphone [UP] or [DWN], to select the desired memory channel.
- 4 Press [MR](1 s).
 - "- +" appears.



- 5 Turn the Tuning control, or press microphone [UP] or [DWN], to select the desired transmit frequency.
- 6 Press [MR].
 - The selected transmit frequency is stored in the memory channel, and the previous mode is restored.
 - Associated data selected in Step 1 such as Tone status/frequency, the frequency step, and DTSS status/code are not altered by this step. However, Transmit Offset status and Reverse status are erased.

RECALLING MEMORY CHANNELS

■ Selecting Channels Sequentially

This method allows you to select, in numerical order by channel number, all memory channels containing data.

1 Press **[MR]**.

- The memory channel used last is recalled.

2 Turn the Tuning control, or press microphone **[UP]** or **[DWN]**, to select the desired memory channel.

- Clockwise or **[UP]**: Increases the channel number.
- Counterclockwise or **[DWN]**: Decreases the channel number.
- Empty memory channels cannot be recalled.
- If **[VFO]** is pressed, the VFO mode is restored.

Note:

- ▶ Memory channels can also be recalled via the microphone keypad. See "Memory Channel Entry" {page 73}.
- ▶ When a split memory channel is recalled, "- +" appears on the Display. Press **[REV]** to display the transmit frequency.

■ Temporary Frequency Changes

You may prefer the flexibility of being able to temporarily change your operating frequency from your microphone after recalling a memory channel rather than changing the channel number. This is possible without leaving Memory Recall.

1 Press **[REV]** + **POWER ON** to enter Menu B.

2 Select Menu No. 56 {page 24}

- The current status appears.



3 Select a status.

- OFF: No frequency changes possible.
- ON: Frequency changes possible.
- Default: OFF

4 Exit Menu B.

With Menu B, No. 56 ON, pressing microphone **[UP]** or **[DWN]** changes the frequency without altering the memory channel number. The frequency step size stored in the selected memory channel is used when changing frequencies regardless what step size is set in Menu A.

The frequency change is only temporary because it does not alter the stored memory channel contents. You can verify this by changing frequency while a memory channel is selected, selecting a new channel with the Tuning control, and then re-selecting the original channel with the Tuning control. The original channel still contains the originally stored frequency.

In the same way, changing settings of Tone/CTCSS, Transmit Offset, etc. can be done as in VFO mode but the new settings will be temporary. Changing these settings does not require Menu B, No. 56 to be ON.

Note: Frequency changes cannot be made when using Channel Display.

MEMORY → VFO TRANSFERS

Transferring the contents of a memory channel or the Call channel to the VFO can be useful if you wish to search for other stations or a clear frequency near the selected memory channel or Call channel frequency. This is a quick operation that will be used frequently, especially if you enjoy exploring the band.

- 1 Press **[MR]** to select Memory Recall, or microphone **[CALL]** to select the Call channel.
- 2 Recall the desired memory channel using the Tuning control.
 - This step is not necessary if the Call channel was selected.

3 Press **[F]**, **[VFO]**.

- The complete contents of the memory channel or the Call channel are copied to the VFO for the appropriate band. For example, data from a memory channel containing a frequency of 144.900 MHz would be transferred to the VFO for the 144 MHz band.
- The VFO for the band receiving the transfer is selected after the transfer is completed.
- A transmit frequency from a split memory channel or split Call channel is not transferred to the VFO.
- A memory channel that contains a frequency outside the range of a VFO that has programmed limits {page 33} will transfer to the VFO. However, as soon as the frequency is changed, the VFO frequency will jump within the programmed range.

Note: Memory→VFO transfers cannot be done while in Full Duplex mode.

ERASING MEMORY CHANNELS

Although it is possible to overwrite existing data in any of the memory channels with new data, at times you may wish to clear data from memory channels without entering new data. It's convenient to clear channels no longer used so you can identify channels that are free for memorizing new frequencies. Memory channels that contain no data cannot be recalled while in Memory Recall.

- 1 Press **[MR]** to select Memory Recall.
- 2 Select the desired memory channel using the Tuning control or microphone **[UP]/[DWN]**.
- 3 Press **[F] + [MR]**.
 - The contents of the memory channel are erased.

Note: Memory channel 1 cannot be erased.

CALL CHANNEL

The Call channel can be used to store any frequency that can be selected on your transceiver that you wish to make your main operating frequency. The Call channel can be programmed with a simplex frequency or a split frequency. No matter what mode the transceiver is in, the Call channel always can be selected quickly. You may wish to dedicate the Call channel on a group-wide basis as an emergency channel only to be used for urgent communications. In this case, one of the Call channel scans {page 61} will be useful.

■ Recalling Call Channel

Press microphone **[CALL]** to retrieve the contents of the Call channel.

- "C" appears on the Display.



- If **[CALL]** is pressed again, "C" clears and the previous mode is restored.
- The Tuning control and microphone **[UP]/[DWN]** do not function while the Call channel is selected.

- It is possible that a memory channel may be recalled and data such as Transmit Offset, Tone, etc. are changed but not stored. If after the Call channel is used you select the previous memory channel, you will find the temporarily changed data is gone, and only the data actually stored in the memory channel will be recalled.

The Call channel defaults are as follows:

Version	Default (MHz)	
	TM-251	TM-451
Canada U.S.A.	144.000	440.000
Europe General	144.000	430.000

The contents of the Call channel cannot be deleted; however, you can overwrite old data with new data as described to the right.

■ Changing Call Channel Contents (Simplex)

- 1 Select the desired frequency and associated data (Tone, CTCSS, DTSS, etc.) using VFO mode or Memory Recall.
- 2 Press **[F]** to select Memory Storage.
 - "F" and a memory channel number appear.



- 3 Press microphone **[CALL]**.

- The selected frequency and associated data are stored in the Call channel. A transmit frequency from a split memory channel is not stored.
- The previous mode is restored.

■ Changing Call Channel Contents (Split)

- 1 Select the desired receive frequency and associated data (Tone, CTCSS, DTSS, etc.) using VFO mode or Memory Recall.
- 2 Press **[F]** to select Memory Storage.
 - "F" and a memory channel number appear.
- 3 Press microphone **[CALL]** (1 s).
 - "- +" appears.



- 4 Select the desired transmit frequency.
- 5 Press **[CALL]**.
 - The selected transmit frequency is stored in the Call channel, and the previous mode is restored.
 - Associated data selected in Step 1 such as Tone status/frequency, the frequency step, and DTSS status/code are not altered by this step. However, Transmit Offset status and Reverse status are erased.

CHANNEL DISPLAY FUNCTION

When this function is switched ON, the transceiver selects Memory Recall and displays only a memory channel number instead of a frequency. During emergency drills and emergency communications, or when participating in communications for important events, channelized operations can increase operating efficiency and maintain security of communications if required.

With Channel Display ON, memory channels can be selected using the Tuning control or microphone **[UP]/[DWN]** as usual. Only memory channels containing data can be selected.

- 1 Press **[REV] + POWER ON** to enter Menu B.
- 2 Select Menu No. 59 {page 24}.
 - The current Channel Display status appears.



- 3 Select a Display status.
 - OFF: Frequency Display
 - ON: Channel Display
 - Default: OFF
- 4 Exit Menu B.

Certain functions cannot be used if Channel Display is activated. The following chart identifies these functions:

Non-functional with Channel Display ON	Page Ref.	Non-functional with Channel Display ON	Page Ref.
[VFO]	32	Programmable Band Scan Limit Select	59
VFO Scan	59	Programmable VFO Limit Select	33
Memory → VFO transfer	42	Display Demonstration mode	66
Frequency step size change	35	Full Duplex mode	91
Memory channel save	39	Transmit Offset select	49
Call channel save	44	Microphone PF keys program	70
Memory channel erase	43	Microphone [VFO]	70
Full reset (Memory channels)	46	Microphone VFO Scan	70
Partial reset (VFO)	46	Microphone memory channel erase	43
Band select	30	Frequency Change during Memory Recall	41

INITIALIZING MEMORY

If your transceiver seems to be malfunctioning, initializing the memory may resolve the problem.

Remember that initializing the memory channels requires that you re-enter any memory channel data again after the initialization if you wish to use those channels. On the other hand, to erase all data from all channels, initialization is a quick way to do this.

■ Partial Reset (VFO)

To initialize all settings except the memory channels, the Call channel and the Page code channels, press **[VFO] + POWER ON**.

■ Full Reset (Memory)

To initialize all settings, press **[MR] + POWER ON**.



When **[MR]** is released, the VFO and memories reset.

Note:

- ▶ Neither Partial Reset nor Full Reset can be done while using the Channel Display function.
- ▶ When the ME-1 Expansion Unit option is installed, Full Reset initializes the expanded memories.

Version	TM-251 Defaults					
	VFO Frequency		Frequency Step		Tone Frequency	
	Main	Sub	Main	Sub	Main	Sub
Canada / U.S.A.	144.000	440.000	5 kHz	25 kHz	88.5 Hz	88.5 Hz
Europe	144.000	430.000	12.5 kHz	25 kHz	1750 Hz	1750 Hz
General	144.000	430.000	12.5 kHz	25 kHz	88.5 Hz	88.5 Hz

Version	TM-451 Defaults						
	VFO Frequency			Frequency Step		Tone Frequency	
	Main	Sub	Exp. ¹	Main	Sub/Exp. ¹	Main	Sub/Exp. ¹
Canada / U.S.A.	440.000	144.000	—	25 kHz	5 kHz	88.5 Hz	88.5 Hz
Europe	430.000	144.000	850.000	25 kHz	12.5 kHz	1750 Hz	1750 Hz
General	430.000	144.000	850.000	25 kHz	12.5 kHz	88.5 Hz	88.5 Hz

¹ The 800 MHz expansion band is on some European and General versions.

OPERATING THROUGH REPEATERS

Compared to simplex communication, you can usually transmit over much greater distances by using a repeater. Repeaters are typically located on a mountain top or other elevated location. Often they operate at higher ERP (Effective Radiated Power) than a typical base station. This combination of elevation and high ERP allows communications over considerable distances.

Repeaters are often installed and maintained by radio clubs, sometimes with the cooperation of local businesses from communications industries. During natural emergencies, repeater networks can be a valuable aid to officials responsible for coordinating communications in a community. This assistance may help save lives.

TRANSMIT OFFSETS

All Amateur Radio voice repeaters use a separate receive and transmit frequency. The transmit frequency may be higher or lower than the receive frequency but the difference in frequencies will be a standard amount, or "standard split". Most repeater configurations fall into one of the following categories:

Offset Direction	TM-251A/E	TM-451A	TM-451E
+	+ 600 kHz	+ 5 MHz	+ 1.6 MHz
-	- 600 kHz	- 5 MHz	- 1.6 MHz
- -	N/A	N/A	- 7.6 MHz

N/A : Not applicable

Whether using VFO mode, Memory Recall, or the Call channel, the transmit offset direction and amount can be changed on the Main band. If using a split memory channel or split Call channel, Transmit Offset cannot be changed. No offset settings can be made for the Sub-band since it cannot be used for transmitting.

SELECTING OFFSET DIRECTION

This function sets the transmit frequency either higher (+) or lower (-) than the receive frequency by a fixed amount. Refer to "SELECTING OFFSET VALUES MANUALLY" {page 50} to change the offset amount.

Press [SHIFT].

- The default is "simplex" (no offset).
- Each press of [SHIFT] changes the offset as follows:

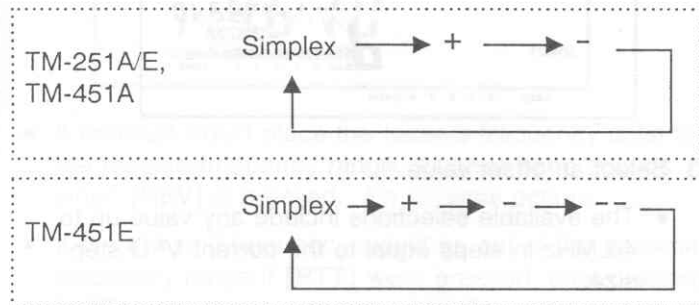

If the offset transmit frequency falls outside the transmit band, transmit is inhibited until the transmit frequency is brought within the band limits by one or more of the following methods:

- Move the receive frequency further inside the band.
- Reduce the offset amount ("SELECTING OFFSETS MANUALLY" {page 50}).
- Reverse the offset direction.

AUTOMATIC TRANSMIT OFFSET

The transceiver takes care of setting the required transmit offset automatically when you select a frequency in VFO mode. This function is always active unless the Reverse function is ON {page 51}.

Due to Automatic Offset, a manually assigned offset direction is only effective until the frequency is changed.

■ U.S.A. and Canada Versions

Automatic Offset for the TM-251A sold in these markets is programmed according to the standard ARRL (American Radio Relay League) Band Plan for repeater offset direction. You can override this programming by following the "SELECTING OFFSET DIRECTION" procedure in the preceding section. Contact your national Amateur Radio association to obtain up-to-date band plans that explain band usage by mode and activity.

	145.5	146.4	147.0	147.6				
145.1	146.0	146.6	147.4	148.0 MHz				
S	-	S	+	S	-	+	S	-

S: Simplex

■ European Versions

The TM-251E Automatic Offset is programmed as follows:

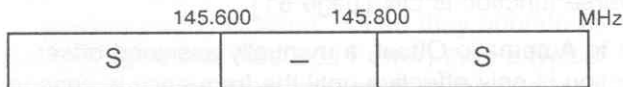

S: Simplex

SELECTING OFFSET VALUES MANUALLY

If you need to use a non-standard offset for any reason, a value can be selected from Menu A as follows:

- 1 Press **[F]** (1 s) to enter Menu A.
- 2 Select **" - + "** {page 22}.

- **" - + "** begins blinking and the current offset value appears.

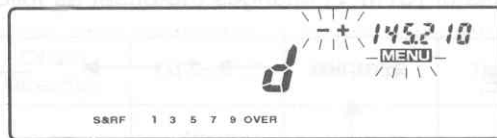

- 3 Select an offset value.

- The available selections include any value up to 40 MHz in steps equal to the current VFO step size.
- Default: d
(d: TM-251A/E: 600 kHz, TM-451A: 5 MHz, TM-451E: 1.6 MHz)

- 4 Exit Menu A.

REVERSE FUNCTION

Each press of **[REV]** switches the receive frequency and the transmit frequency. When used while monitoring a repeater, it's possible to check the signal strength of a station accessing the repeater. If the station's signal is strong, it's best to move to a simplex frequency to continue the contact and free-up the repeater.



- If reversal would place the receive frequency outside the receive frequency range, an error beep sounds when **[REV]** is pressed. No reversal occurs.
- If the transmit frequency would go out of the transmit frequency range if **[PTT]** were pressed, then pressing **[PTT]** causes an error beep and Receive is selected.
- Reverse cannot be activated while **[PTT]** is held down.
- Automatic Offset does not function while Reverse is ON.

TONE ACCESS

Each press of **[TONE/CTCSS]** changes the Tone and CTCSS functions as follows:

No indicator → **TONE** → **CTCSS**

No indicator	Subaudible tone not transmitted and tone squelch not functional.
TONE	Subaudible tone transmitted.
CTCSS	Subaudible tone transmitted and tone squelch functional. This indicator does not appear if the CTCSS unit is not installed.

■ Selecting a Tone Frequency

Often a Tone frequency is required to access repeaters. For example, 88.5 Hz may be needed in the U.S.A. or Canada, and 1750 Hz is used in Europe. The Tone frequencies listed below can be selected.

No.	Freq (Hz)	No.	Freq (Hz)	No.	Freq (Hz)
01	67.0	14	107.2	27	167.9
02	71.9	15	110.9	28	173.8
03	74.4	16	114.8	29	179.9
04	77.0	17	118.8	30	186.2
05	79.7	18	123.0	31	192.8
06	82.5	19	127.3	32	203.5
07	85.4	20	131.8	33	210.7
08	88.5	21	136.5	34	218.1
09	91.5	22	141.3	35	225.7
10	94.8	23	146.2	36	233.6
11	97.4	24	151.4	37	241.8
12	100.0	25	156.7	38	250.3
13	103.5	26	162.2	(39) ¹	(1750)

¹TM-251E/TM-451E only

The following procedure allows you to select any of the available tones.

1 Press [F], [TONE/CTCSS].

- "TONE" blinks and the current Tone frequency appears.



2 Turn the Tuning control, or press microphone [UP]/[DWN], to select a Tone frequency.

3 Press any button to store the frequency and return to the previous mode.

■ European Versions

To send 1750 Hz, "1750" must first be selected from the Tone frequency list by using the "Selecting a Tone Frequency" {page 52} procedure.

A 1750 Hz Tone is then transmitted by pressing [TONE/CTCSS] or microphone [PF]. If you prefer, this function can be assigned to other microphone keys. See "Configuring the PF Keys" {page 70}. Also, if CTCSS is ON, 1750 Hz cannot be selected {page 74}.

Transmit Hold for sending the 1750 Hz repeater access tone can be enabled via Menu B.

- 1 Press [REV] + POWER ON to enter Menu B.
- 2 Select Menu No. 54 {page 24}.
 - The current 1750 Hz Hold status appears.



- 3 Select a status.
 - OFF: 1750 Hz sent only as long as [TONE/CTCSS] is pressed.
 - ON : 1750 Hz sent for 2 seconds continuously.
 - Default: OFF
- 4 Exit Menu B.

Note: If the Tone function is assigned to microphone [PF], then [PF] functions the same as [TONE/CTCSS].

AUTOPATCH (U.S.A. and Canada Versions)

Some repeaters offer a service called Autopatch. This feature allows you to dial a telephone number from your transceiver and carry on a telephone conversation. This repeater function cannot be used for commercial transactions, but it can save lives when used appropriately during emergencies.

Autopatch requires the use of a DTMF (Dual Tone Multi-Frequency) keypad on your microphone. The keypad includes the 12 keys found on a push-button telephone plus an additional 4 keys (A, B, C, D). These additional keys are required for various control operations by some repeater systems.

■ Activating the Microphone Keypad

- 1 Press and hold [PTT].
- 2 Press the numeric keys on the keypad in sequence to send DTMF tones.

DTMF Tones

Freq (Hz)	1209	1336	1477	1633
697	1	2	3	A
770	4	5	6	B
852	7	8	9	C
941	*	0	#	D

Note: Some repeaters require a special key sequence to activate Autopatch. Check with the control operator.

DUAL TONE MULTI-FREQUENCY (DTMF) MEMORY

The following DTMF functions require an MC-45DM/DME DTMF microphone or a TH-7 transceiver.

■ Making DTMF Calls

To make a DTMF call, hold down the microphone [PTT] and press [0] to [9], [A], [B], [C], [D], [*], or [#].

- The microphone is muted and the corresponding DTMF tones are transmitted.
- If two keys are pressed, only the tone combination for the key pressed first is sent.

■ Storing DTMF Numbers

Be aware that audible DTMF tones from other transceivers near you may be picked up by your MC-45DM/DME or TH-7 microphone element. If so, this could prevent the following function from working correctly. To store a DTMF number up to a maximum of 15 digits in any of 10 dedicated DTMF memories, follow the procedure below:

- 1 Press [REV] + **POWER ON** to enter Menu B.
- 2 Select Menu No. 65 {page 24}.
- 3 Turn the Tuning control, or press microphone [UP]/[DWN], to select "P ---".

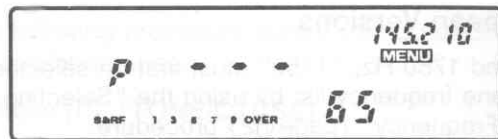

- 4 Enter the digits of the number to be stored using the keypad.

- If you enter an incorrect digit, press microphone [CALL] to erase all digits entered, and start again.
- The non-numeric keys are displayed as follows: [A]: A, [B]: b, [C]: C, [D]: d, [*]: E, [#]: F

- 5 Press microphone [PF].

- The last 3 digits entered are visible.



- 6 Press a single key [0] to [9] to store the number in a DTMF memory.

- The Display reverts to "P ---" again ready for the next DTMF number to be stored.

- 7 Exit Menu B.

■ Confirming Stored DTMF Numbers

- 1 Press **[REV] + POWER ON** to enter Menu B.
- 2 Select Menu No. 65 {page 24}.
- 3 Turn the Tuning control, or press microphone **[UP]/[DWN]**, to select "P ---".
- 4 Press microphone **[CALL]**.
 - "---" disappears.

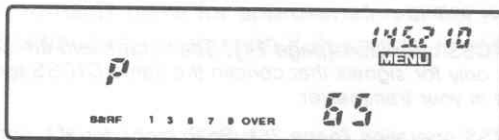

- 5 Press a single key **[0]** to **[9]** to recall the DTMF memory containing the number to confirm.
- 6 Exit Menu B.

■ Transmitting Stored DTMF Numbers

To transmit a stored DTMF number, follow the procedure below:

- 1 Press **[PTT] + [PF]**.
 - "P" appears.

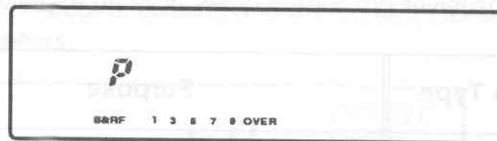

- 2 Press a single key **[0]** to **[9]** to recall the DTMF memory containing the number to transmit.

SCAN

Scan is a useful feature for hands-off monitoring of your favorite frequencies. After becoming comfortable with how to use all types of Scan, the monitoring flexibility gained will increase your operating efficiency.

This transceiver provides 5 types of Scan as follows:

Scan Type	Purpose
Memory Scan	Quick activity update of your favorite frequencies.
Band Scan	General update on band activity.
Programmable Band Scan	Similar to Band Scan except over a narrower segment of the band.
Call/VFO Scan	Monitor the Call channel plus any VFO frequency.
Call/Memory Scan	Monitor the Call channel plus your favorite frequency.

Note:

- ▶ Remember to adjust the squelch threshold level {page 28} before using Scan.
- ▶ Always turn OFF Tone Alert {page 86}, Monitor {page 70}, and Page {page 79} before using Scan.
- ▶ When using S-meter Squelch, Scan stops when the received signal strength matches or exceeds the S-meter setting. Scan resumes 2 seconds after the signal level drops below the S-meter setting.
- ▶ For CTCSS operation {page 74}, Scan stops and the squelch opens only for signals that contain the same CTCSS tone that is stored in your transceiver.
- ▶ For DTSS operation {page 75}, Scan stops for any signal received; however, the squelch opens only for signals that contain the same DTSS code that is stored in your transceiver.
- ▶ When both CTCSS and DTSS are ON, Scan stops for signals that contain the matching CTCSS tone. However, the squelch opens only when the matching DTSS code is received.

Before using Scan, it's necessary to decide under what condition you want your transceiver to continue scanning after detecting and stopping for a signal. You can choose Time-operated Scan or Carrier-operated Scan. The default is Time-operated Scan.

■ Time-Operated Scan

Your transceiver stops scanning after detecting a signal, remains there for approximately 5 seconds, and then continues to scan even if the signal is still present.

■ Carrier-Operated Scan

Your transceiver stops scanning after detecting a signal and remains on the same frequency until the signal drops out. There is a 2 second delay between signal drop-out and scan resumption to allow time for any responding stations to begin transmitting.

Note:

- ▶ Turning the Tuning control clockwise or pressing microphone [UP] after a signal that has stopped Scan clears, causes scanning to resume immediately upward.
- ▶ Turning the Tuning control counterclockwise, or pressing microphone [DWN] after a signal that has stopped Scan clears, causes scanning to resume immediately downward.

SELECTING SCAN RESUME METHOD

Use the following procedure to switch your transceiver between Time-operated Scan and Carrier-operated Scan.

- 1 Press [F] (1 s) to enter Menu A.
- 2 Select "CO" {page 22}.

- "CO" begins blinking and the current CO selection appears.



3 Select a Scan Resume method.

- The available selections are CO (carrier-operated) or TO (time-operated).
- Default: TO
- 4 Exit Menu A.
- "CO" remains ON if Carrier-operated Scan was selected.

MEMORY SCAN

Memory Scan allows all memory channels containing data to be scanned regardless from which band the frequencies were stored.

1 Press [MR] (1 s).

- Scan starts with the channel last recalled, then scans through the memory channels in the same direction last used for scanning.
- The default direction is downward through the channels.

2 To reverse the scan direction, turn the Tuning control or press microphone [UP]/[DWN].

- Upward scan: Turn Tuning clockwise, or Press microphone [UP].
- Downward scan: Turn Tuning counterclockwise, or Press microphone [DWN].

3 To cancel Memory Scan, press any key excluding the microphone keypad keys.

Note: At least 2 or more memory channels must contain data for scan to function. Also, the squelch must be closed for Scan to function {page 28}.

■ Locking-Out Memory Channels

Memory channels that you prefer not to monitor while scanning can be locked-out. Lock-out any memory channel with the following procedure:

1 Press [MR] to select Memory Recall.

2 Select the memory channel to be locked-out using the Tuning control or microphone [UP]/[DWN].

3 Press [LOW] (1 s) to lock-out the selected channel.

- A "star" icon appears above the memory channel number to indicate the channel has been locked-out.
- By default, all memory channels are not locked out.



Lock-out for an individual channel can be canceled by repeating the above procedure.

BAND SCAN

Band Scan allows you to scan all frequencies from the lowest frequency to the highest frequency on each band that your transceiver is capable of receiving. The currently selected frequency step size for each band is used.

- 1 Press **[VFO]** to select VFO mode.
- 2 Select the band that you want to scan by pressing **[F]**, **[REV]**.
- 3 Press **[VFO]** (1 s), and Scan starts at the frequency currently displayed.
 - The decimal starts blinking to indicate scanning in progress.
 - The scan direction is the same as last used.
 - The default direction is downward in frequency.



- 4 To reverse the scan direction, turn the Tuning control, or press microphone **[UP]**/**[DWN]**.
 - Upward scan : Turn Tuning clockwise, or press microphone **[UP]**.
 - Downward scan: Turn Tuning counterclockwise, or press microphone **[DWN]**.

- 5 To cancel Band Scan, press any key excluding the microphone DTMF keypad keys.

PROGRAMMABLE BAND SCAN

This type of scan is similar to Band Scan except the programmable aspect allows you to set scan limits within the bands that can be selected by the transceiver.

■ Setting Scan Limits

- 1 Press **[VFO]** to select VFO mode.
- 2 Select the band on which you want to set the Band Scan limits by pressing **[F]**, **[REV]**.
- 3 Press **[REV]** + **POWER ON** to enter Menu B, then select Menu No. 61 {page 24}.
 - The current upper limit appears.
- 4 Turn the Tuning control, or press microphone **[UP]** or **[DWN]**, to select the desired upper limit.



5 Select Menu B, No. 60.

- The current lower limit appears.

6 Turn the Tuning control, or press microphone [UP] or [DWN], to select the desired lower limit.



7 Exit Menu B.

Note:

- ▶ The upper limit is set first above; however, either lower or upper limit may be set first provided the upper limit is placed in Menu B, No. 61 and the lower limit is placed in Menu B, No. 60.
- ▶ The lower limit must be lower in frequency than the upper limit.
- ▶ To reset the limits to their default values, you can do a Partial or Full Reset {page 46}.



■ Using Programmable Band Scan

1 Select a frequency between the programmed scan limits. You may also choose a frequency equal to one of the limits.

- If you select a frequency that is outside the programmed scan limits, the transceiver will start Band Scan automatically instead of Programmable Band Scan.

2 Press [VFO] (1 s), and Scan starts at the frequency currently displayed.

- The decimal starts blinking to indicate scanning is in progress.
- The scan direction is the same as last used.
- The default direction is downward in frequency.

3 To reverse the scan direction, turn the Tuning control, or press microphone [UP]/[DWN].

- Upward scan: Turn Tuning clockwise, or press microphone [UP].
- Downward scan: Turn Tuning counterclockwise, or press microphone [DWN].

4 To cancel Programmable Band Scan, press any key excluding the (microphone) DTMF keypad keys.

Note: Squelch must be closed for Scan to function {page 28}.

CALL/VFO SCAN

Use Call/VFO scan to monitor both the Call channel and the current VFO frequency.

- 1 Press **[VFO]**.
- 2 Press microphone **[CALL]** (1 s).
- 3 To cancel Call/VFO Scan, press any key other than the microphone DTMF keypad keys.



CALL/MEMORY SCAN

Use Call/Memory Scan to monitor both the Call channel and the memory channel last used.

- 1 Press **[MR]**.
- 2 Press microphone **[CALL]** (1 s).
- 3 To cancel Call/Memory Scan, press any key other than the microphone DTMF keypad keys.



AUXILIARY FUNCTIONS

LOCK

Occasionally, you may want to lock the buttons, keys and the Tuning control to prevent accidentally changing any transceiver settings. This transceiver has 2 lock functions for this purpose.

■ Transceiver Lock

Press **[F]**, **[LOW]**.

- "LOCK" appears when the Transceiver Lock function is ON.
- Each time this key combination is pressed, the buttons on the transceiver except **[PWR]** toggle between locked and unlocked.



The following buttons and controls on the transceiver function normally even when Transceiver Lock is ON:

- **[F]**
- **[PWR]**
- **VOL** control
- **SQL** control

■ Microphone Lock

Slide the Lock switch on the rear of the microphone to "LOCK".

- Slide the Lock switch back to the original position when you want to disable Microphone Lock.
- The DTMF keypad and **[PTT]** function normally even when Microphone Lock is ON.

AUTOMATIC POWER OFF (APO)

After a programmable time period elapses with no key entries, APO turns OFF the power; however, 1 minute before the power turns OFF, "APO" starts blinking and a series of warning tones sound.

If the squelch opens or any keys are pressed during the time period while APO is ON, the timer resets. When the squelch closes or key entry stops, the timer begins counting again from 0. When Tone Alert is switched ON {page 86}, APO still turns OFF the power if no key entry is made for 24 hours.

Activate APO by using the following procedure:

- 1 Press **[F]** (1 s) to enter Menu A.
- 2 Select "APO" {page 22}.
 - "APO" starts blinking and the current APO status appears.



- 3 Select a timer value.
 - The available selections are OFF, 60, 120, and 180 minutes.
 - Default: OFF

4 Exit Menu A.

- "APO" remains ON if a timer value was selected.

To restore power after APO has been activated, press **[PWR]** twice.

Note:

- ▶ APO cannot be turned OFF if the Display Dimmer is OFF.
- ▶ Switching OFF the Dimmer while APO is OFF causes APO to be set to 180 minutes. If APO was set for 60 or 120 minutes, the current APO setting remains in effect.

BEEP TONE

The transceiver beeps each time you press a button or key. Also, pressing [PTT] generates a beep any time transmission is not possible on the frequency selected. For example, the transceiver beeps when [PTT] is pressed while the Sub-band is selected or while a transmit offset is selected that places the transmit frequency outside the transceiver's transmit band. Beep volume can be varied by turning the VOL control.

If you prefer, you can cancel Beep for silent operation.

- 1 Press [F] (1 s) to enter Menu A.
- 2 Select "BEEP" {page 22}.
 - "BEEP" starts blinking and the current Beep status appears.



- 3 Select a status.
 - OFF: Disables Beep.
 - ON: Enables Beep.
 - Default: ON
- 4 Exit Menu A.

DISPLAY DIMMER

The Display illumination can be varied to suit the lighting conditions where you are operating. Select the brightness level that provides the best Display visibility.

If the Display Dimmer is switched OFF, APO switches ON automatically with a timer value of 180 minutes (3 hours). After this time passes, the power is switched OFF. Switching ON the transceiver again restores the default brightness of "d2".

- 1 Press [F] (1 s) to enter Menu A.
- 2 Select "DIM" {page 22}.
 - "DIM" starts blinking and the current Dimmer level appears.



- 3 Select a level.
 - The available selections are d1, d2, d3, d4, and OFF in descending order of brightness.
 - Default: d2
- 4 Exit Menu A.

DISPLAY MODE

While using Tone/CTCSS, DTSS or Page, there are several options available for how information appears on the Main Display and the smaller Sub-display. Review the following chart to decide the arrangement you prefer, then select your choice from Menu A.

Menu A Selection	Main Display	Sub-display
OFF	<ul style="list-style-type: none">• Operating frequency	OFF
Sub 1	<ul style="list-style-type: none">• Operating frequency	<ul style="list-style-type: none">• Tone/CTCSS frequency or• DTSS code or• Page code
Sub 2	<ul style="list-style-type: none">• Tone/CTCSS frequency or• DTSS code or• Page code	<ul style="list-style-type: none">• Operating frequency¹

¹ If Tone/CTCSS, DTSS, and Page are OFF, the operating frequency appears on the Main Display.

Note: Both Display mode and Full Duplex {page 91} cannot be activated at the same time.

- 1 Press [F] (1 s) to enter Menu A.
- 2 Select the Display mode {page 22}.
 - The current Display status appears.



- 3 Select your choice for the Display mode.
 - The available selections are OFF, Sub-display 1, and Sub-display 2.
 - Default: OFF
- 4 Exit Menu A.

If using more than 1 of the 3 functions (Tone/CTCSS, DTSS, Page), the function activated last will have its parameter displayed when using Sub 1 or Sub 2 mode.

For example while using Sub 2, if Tone is switched ON followed by DTSS, the current DTSS code will appear on the Main Display and the operating frequency will appear on the Sub-display. The Tone frequency would not be visible. To display the Tone frequency on the Main Display, disable Tone then re-enable Tone. This action effectively makes Tone the last function selected. The DTSS code will not be visible now.

Note:

- ▶ If using Sub 2 while Tone is ON, the Tone/CTCSS frequency must be selected by turning the Tuning control or pressing microphone [UP]/[DWN]. You cannot select a new Tone/CTCSS frequency by using [F], [TONE/CTCSS].
- ▶ To change the operating frequency while using Sub 2, first press [VFO], or switch OFF the Tone/CTCSS and DTSS/Page functions before attempting to change the frequency.
- ▶ If Sub 1 or Sub 2 is selected after both Tone/CTCSS and Page/DTSS are ON, the Page/DTSS code is given priority. In this case, press [TONE/CTCSS] to switch Tone OFF and then ON again before attempting to change the Tone/CTCSS frequency.
- ▶ When using Sub 2 with Page ON, you can change the Page Memory after pressing [F], [DTSS]. When the small "P" begins blinking, use the Tuning control or microphone [UP]/[DWN] to change the Page memory. To lock-out the selected Page memory, press [MR] or microphone [MR]. Pressing any key other than Front Panel [MR] or microphone [UP]/[DWN]/[MR], or simply waiting for 10 seconds, finalizes the new Page memory selection.

DISPLAY DEMONSTRATION MODE

Initiating the Display Demonstration mode causes the following sequence to start:

- The normal Display appears with maximum illumination after power is switched ON.
- Ten seconds after power ON, all Display segments light, then the segments randomly disappear segment by segment until the Display is blank.
- A series of 3 different messages appear with each message blinking on the Display for about 10 seconds.

This cycle repeats until the Display Demonstration mode is deactivated. The transceiver can be used in the demonstration mode, if desired. Using any buttons or controls restores the normal Display immediately. If there is no button or key entry, or Tuning control adjustment, for more than 10 seconds, the transceiver reverts back to the Display Demonstration mode.

Note: To exit from this mode requires either a Partial Reset or Full Reset {page 46}. Switching OFF the transceiver power does not cancel the mode. Also, this mode cannot be used with Channel Display {page 45}.

Press [DTSS] + **POWER ON** to activate Display Demonstration mode.

REMOTE CONTROL

This feature allows numerous transceiver functions to be changed conveniently from a microphone such as the MC-45DM or MC-45DME without using the Front Panel buttons or controls. These microphones are equipped with a DTMF keypad that is used in conjunction with other keys and buttons on the microphone to generate the commands that control the transceiver.

Alternatively, the TH-7 Dual Bander can be used as the controlling mechanism in place of a keypad-equipped microphone. The TH-7 is a compact, handy FM transceiver available in some areas only. Be aware that audible DTMF tones from other transceivers near you may be picked up by your MC-45DM/45DME or TH-7 microphone element. If so, this could prevent the following functions from working correctly.

Note:

- ▶ *Connecting an external unit such as the TH-7 causes your transceiver to switch to EXT control mode. Disconnecting the external unit causes the transceiver to return to Microphone Remote Control.*
- ▶ *U.S.A. Version only: It is not legal to transmit control codes on the 144 MHz band. Transmit control codes only on the 440 MHz band.*

Menu B No. 50	Receive Mode	Transmit Mode
OFF	Turns OFF Remote Control.	Allows DTMF tone transmission:
ON	Allows Remote Control of the Front Panel. [A] is the ENTER key: <ul style="list-style-type: none">• VFO mode →Direct digit-by-digit frequency entry• Memory Recall →Channel number entry	<ol style="list-style-type: none">1 Press [PTT] + [PF].2 Enter DTMF memory number.

Turning the Remote Control function ON causes the Meter scale to blink.

1 Press [REV] + POWER ON to enter Menu B.

2 Select Menu No. 50 {page 24}.

- The current Remote Control status appears.



3 Select a status.

- See chart above.
- Default: OFF

4 Exit Menu B.

Note: Remote Control cannot be used if Full Duplex or External Control via a TH-7 is being used.

REMOTE FUNCTIONS USING MC-45DM/DME

When your transceiver is configured for Front Panel Remote Control, the keypad can be used to control the functions as shown in the accompanying diagram.

The keys on the microphone keypad have duplicate functions of the equivalent buttons on the Front Panel of the transceiver.

Note:

- ▶ To activate the functions shown in the upper third of each square in the diagram, press [D] first.
- ▶ When VOLUME or SQUELCH are ON, vary the volume and squelch threshold by pressing [*] and [#].
- ▶ Both VOLUME and SQUELCH cannot be activated at the same time. Only one of the 2 functions can be ON at any time.

[F],[KEY]

1

T.ALT

[KEY]

SHIFT

[KEY](1 s)

PLAYBACK

2

T.SEL

TONE/CTCSS

—

3

BAND

REV

—

A

—

ENTER

—

[F],[KEY]

4

DTSS/PAGE SEL

[KEY]

DTSS

[KEY](1 s)

PAGE

5

MIC.LOCK ON

PAGE

—

6

MIC.LOCK OFF

PLAYBACK

—

[F],[KEY]

7

—

[KEY]

VOL ON/OFF

[KEY](1 s)

—

8

LOCK

LOW

LOCK-OUT

9

—

SQL ON/OFF

—

[F],[KEY]

*

DOWN

[KEY]

DOWN

[KEY](1 s)

—

0

—

LOCK-OUT

—

#

UP

UP

—

D

CANCEL[F]

[F]

MENU A

■ Configuring the PF Keys

The Programmable Function (PF) keys are the horizontal row of 4 keys located on the face of the microphone. These keys are identified as follows:

Key Label	General Key Name	Default Function	To Restore Default Function
PF	PF1	Monitor ¹	[F] + POWER ON
MR	PF2	Memory Recall	Follow the procedure below.
VFO	PF3	VFO Select	Follow the procedure below.
CALL	PF4	Call Channel	[SHIFT] + POWER ON

¹TM-251/451E: Tone function

If you prefer, other functions can be assigned to the PF keys:

- 1 Press one of the following key combinations depending on which key you want to reassign:

[PF] + POWER ON, or
Microphone **[MR] + POWER ON**, or
Microphone **[VFO] + POWER ON**, or
[CALL] + POWER ON

- "PF1", "PF2", "PF3", or "PF4" appears.

- 2 Press the key on the Front Panel that you want to assign to the microphone PF key pressed in Step 1.

- The Front Panel key is now assigned to the PF key.
- Also, the Front Panel key will still function normally after "copying" its function to a PF key.

Note:

- ▶ The function of the **[F]** key cannot be assigned using the above procedure. To assign the **[F]** key function to PF1, press **[TONE/CTCSS] + POWER ON**.
- ▶ If you decide to restore a default function, follow "To Restore Default Function" instructions in the chart for the function that you want to restore, or simply do a Full Reset {page 46}.
- ▶ After assigning **[SHIFT]**, **[DTSS]**, or **[LOW]** to a PF key, pressing the PF key for more than 1 second starts the Playback, Page, or Lock-out function respectively.

■ Monitor Function

Monitor allows you to override any squelch systems being used so activity on a frequency can be heard. This is handy to quickly listen to a frequency without actually changing the squelch setting or disabling the squelch system.

Press microphone **[PF]** to toggle the Monitor function ON and OFF.

REMOTE FUNCTIONS USING TH-7

The transceiver can be controlled with the TH-7 simply by connecting the cable supplied with the TH-7 between the transceivers. The TH-7 is also useful as a speaker-microphone for the transceiver. See the TH-7 instruction manual for details. The Remote Control settings in Menu B, No. 50 do not affect operation of the TH-7.

You can assign the functions of the keys on the transceiver to the PF (Programmable Function) keys on the TH-7.

You can also assign the following key functions:

- Functions of keys, other than **[F]**, **[PWR]** and the Tuning control.
- Functions initiated by pressing **[F]**, **[KEY]**.
- Functions initiated by pressing **[F] + [KEY]**.

You cannot assign the following key functions:

- Functions initiated by pressing **[KEY]** (1 s).
- Functions initiated by pressing **[KEY] + POWER ON**.
- Microphone key functions

When using a TH-7 for Remote Control, switch ON the Microphone Connector Receive Audio (RD output) function. This function is controlled via Menu B, No. 58. The default is ON. The DTMF dialer cannot be used from a TH-7.

KEYPAD DIRECT ENTRY

The MC-45DM/DME numeric keys can be used to enter either frequencies or memory channel numbers directly. For this, Menu B, No. 50 must be set to ON. The key that instructs the transceiver to prepare for direct entry is **[A]**.

- Menu B, No. 50 set to ON → **[A]** functions as the ENTER key.

■ Frequency Entry

Entering the desired frequency directly via the keypad can be the fastest way of selecting a different frequency especially when a small frequency step has been selected. If the new frequency is hundreds of kHz or more from the current frequency, and you don't have the new frequency stored in any memory channels, direct entry may be the quickest way to select your frequency.

1 Press **[VFO]** to select VFO mode.

2 Press **[A]**.

- Microphone **[A]** is the ENTER key while Menu B, No. 50 is ON.
- " - " indicators appear. The transceiver is ready to receive frequency digits from the microphone.

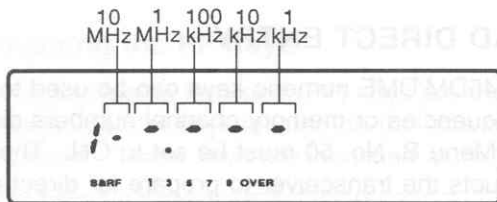

3 Press keys [0] to [9] for the frequency you want.

- Enter the digits in order from the most significant down to the least significant.
- Pressing keys other than [0] to [9] or [A] cancels direct entry and restores VFO mode.
- For versions with receiver coverage wider than 10 MHz, the 10 MHz digit must be entered. Otherwise, begin entering from the 1 MHz digit.
- Except for the 1 kHz digit, entering a digit that is outside the allowable range causes the nearest digit within range to be displayed. For the 1 kHz digit, pressing [0] to [4] selects "0" and pressing [5] to [9] selects "5".
- When the current step size is 5 kHz, 10 kHz, 15 kHz, or 20 kHz, enter numeric values down to the 1 kHz digit. Enter either 0 or 5 for the 1 kHz digit.
- When the current step size is 12.5 kHz or 25 kHz, entering the 10 kHz digit completes frequency setting. The 10 kHz and subsequent digits are set according to which key is pressed for the 10 kHz digit as shown in the chart.

10 kHz Key	Frequency (kHz)	10 kHz Key	Frequency (kHz)
0	00	5	50
1	12.5	6	62.5
2	25	7	75
3	37.5	8	87.5
4	37.5	9	87.5

Note:

- ▶ If any key other than [0] to [9] or [A] is pressed, or if the next entry is not made within 10 seconds, the previous frequency will be restored.
- ▶ If [A] is pressed while entering the frequency, the new data is accepted for the digits entered and the previous data remains unchanged for the digits not yet entered.
- ▶ Turning the Tuning control, or pressing microphone [UP]/[DWN], while entering the frequency cancels the new numeric data entered, and raises or lowers the previously displayed frequency.

■ Memory Channel Entry

Memory Channel Entry is similar to Frequency Entry except this function is used when Memory Recall is selected. If you want to choose a memory channel quickly without scrolling through many other channels, this is the method to use.

- 1 Press **[MR]** to select Memory Recall.
- 2 Press **[A]**.
 - Microphone **[A]** is the ENTER key while Menu B, No. 50 is ON.
 - "--" appears indicating the transceiver is ready to receive memory channel digits from the microphone.

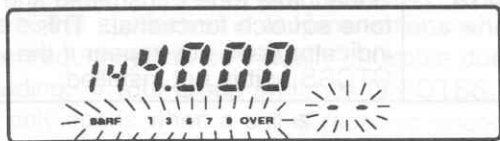

- 3 Enter a memory channel from 1 to 40 (**[0]**, **[1]** to **[4]**, **[0]**).

- Pressing keys other than **[0]** to **[9]** or **[A]** cancels direct entry and restores Memory Recall.
- If your transceiver is equipped with an optional ME-1 Expansion Unit, input 3 digits for the memory channel number.

The transceiver automatically switches to the new memory channel after entry of the last digit.

CONTINUOUS TONE CODED SQUELCH SYSTEM (CTCSS)

The CTCSS feature is available only when the TSU-8 CTCSS unit is installed.

CTCSS functions by using subaudible tones that are superimposed by a transmitter on a transmitted signal to control a receiver's squelch. When used in combination with the noise squelch, CTCSS provides a simple method to selectively choose which stations will be heard. This transceiver offers a total of 38 standardized CTCSS frequencies.

Monitoring is less tiring when using CTCSS since you hear only those stations on a particular frequency that are transmitting the CTCSS tone that you have selected.

SELECTING CTCSS FREQUENCIES

Refer to the chart of frequencies available and the procedure for selecting the desired frequency on page 52.

USING CTCSS

To switch ON CTCSS, repeatedly press [TONE/CTCSS] until "CTCSS" appears on the Display. Each press of [TONE/CTCSS] changes the Display as below:

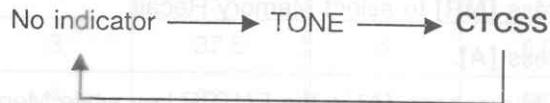

No indicator	Subaudible tone not transmitted and tone squelch not functional.
TONE	Subaudible tone transmitted.
CTCSS	Subaudible tone transmitted and tone squelch functional. This indicator does not appear if the CTCSS unit is not installed.

Note:

- ▶ When using DTSS or Page with CTCSS, the squelch opens only if the correct CTCSS tone is received and the received DTSS or Page code matches the code stored in your transceiver.
- ▶ If CTCSS and Tone Alert are ON, there is no speaker output except the alarm tone even if a signal is received with the correct CTCSS frequency.

DUAL TONE SQUELCH SYSTEM (DTSS)

DTSS provides a more refined method than CTCSS to selectively communicate with specific stations. A total of 1000 3-digit DTMF (Dual Tone Multi-Frequency) codes are available to be used as addresses for stations with which you want to communicate. These codes can be changed easily and regularly as required. Due to the quantity of different codes, large networks can be set up that use DTSS for selective calling and receiving. By including group codes in the network plan, sub-groups within the network can be contacted without disturbing others monitoring the same frequency.

If your needs are simpler, DTSS also serves a useful purpose when you only want direct communication with a few close friends on your favorite frequency. A good example of this application is at Hamventions when a particular frequency can be virtually unusable due to overcrowding. If your group switches ON DTSS, your squelch only opens when a call is received encoded with the same code that is stored in your transceiver. If no signal is received for more than 2 seconds after DTSS has opened the squelch, the squelch then closes. Anytime you want to monitor all activity on the channel, you simply switch OFF DTSS.

ACTIVATING DTSS

To switch ON DTSS, press **[DTSS]**.

- "DTSS" appears when DTSS is ON.
- Each press of **[DTSS]** toggles the DTSS function ON and OFF.



Pressing **[PTT]** automatically sends your DTSS code. Pressing **[DTSS]** while **[PTT]** is held down, resends your code with the exception of European versions using the Tone function.

Note:

- ▶ When **[DTSS]** is pressed with Page ON, Page is automatically switched OFF, and DTSS is switched ON.
- ▶ Both DTSS status and a DTSS code can be stored in a memory channel or the Call channel. Further, when recalling either a memory channel or the Call channel with DTSS status ON while using the VFO with Page switched ON, Page is given priority and the DTSS status switches OFF.
- ▶ The microphone is inhibited while the DTSS code is transmitted.
- ▶ If DTSS and Tone Alert are ON, there is no speaker output except the alarm tone even if a signal is received with the correct DTSS code.

STORING DTSS CODES

You can store a DTSS code from 000 to 999 by using the Tuning control or the microphone. Be aware that audible DTMF tones from other transceivers near you may be picked up by your MC-45DM/DME or TH-7 microphone element. If so, this could prevent the following function from working correctly.

- 1 Press **[VFO]** to select VFO mode.
- 2 Press **[DTSS]** to turn ON DTSS.
 - "DTSS" appears.



- 3 Press **[F]**, **[DTSS]** to activate Code Select.
 - "C" and "DTSS" start blinking.



- 4 Select a 3-digit number for the DTSS code by turning the Tuning control or by pressing microphone **[UP]**/**[DWN]**.

- Alternatively, if your microphone is equipped with a DTMF keypad, the DTSS code also can be entered by using the keypad numeric keys. Press the 3 numeric keys in sequence for the code you want and ignore Step 5.

5 Press **[DTSS]**.

- The VFO mode is restored.

Note: If you press keys other than the microphone DTMF numeric keys, or if you do not make the entry in Step 4 within 10 seconds, the VFO mode is restored. Digits already entered will be stored.

DTSS AND REPEATERS

Pressing **[PTT]** transmits the DTSS signal after a short delay. This delay helps avoid losing DTSS data when using repeaters with long response times that may miss receiving a portion of the DTSS code.

The delay time is 350 ms during simplex operation.

When using a transmit offset or a split frequency, you can change 350 ms (default) to 550 ms.

- 1 Press **[REV]** + **POWER ON** to enter Menu B.

2 Select Menu No. 53 {page 24}.

- The current Delay Time appears.



3 Select a time value.

- The times available are 350 or 550 ms.
- Default: 350 ms

4 Exit Menu B.

Note:

- ▶ DTSS cannot be used with some repeaters.
- ▶ The delay time selected using Menu No. 53 also applies to Message Playback Control.

MESSAGE PLAYBACK CONTROL VIA DTSS

Message Playback Control is available only on U.S.A., Canada, some European, and some General versions. Check with your local **KENWOOD** dealer for specific information. This useful function allows you to send a specific pre-programmed DTSS code to your transceiver that triggers the transceiver to switch to Transmit and playback the contents of its message memory. Wherever you are, as long as you can transmit a signal that can be received by your transceiver that has the Message Playback Control function enabled, you can retrieve your messages. Refer to "MESSAGE RECORDING" {page 88} for more information on the record/playback functions.

1 Press [REV] + POWER ON to enter Menu B.

2 Select Menu No. 72 {page 24}.

- The current Message Playback Control status appears.



3 Select a status.

- OFF: DTSS code will not initiate message memory playback.
- ON: Message Playback is possible by sending correct DTSS code.
- Default: OFF

4 Exit Menu B.

■ Setting Message Playback DTSS Code

This procedure allows you to change the default DTSS code required to use the Message Playback function.

- 1 Press **[REV] + POWER ON** to enter Menu B.
- 2 Select Menu No. 73 {page 24}.
 - The current Message Playback DTSS code appears.



- 3 Select a code using the Tuning control or the microphone **[UP]/[DWN]** buttons.
 - Alternatively, if your microphone is equipped with a DTMF keypad, the DTSS code also can be entered by using the keypad numeric keys. Press the 3 numeric keys in sequence for the code you want.
 - Default: 919
- 4 Exit Menu B.

Note: If the Message Playback DTSS code is the same as the DTSS code for operating, the Message Playback code is given priority. However, if the same codes are set and the Message Playback function is switched OFF, the operating DTSS code is given priority.

PAGE

OVERVIEW

Similar to DTSS, Page uses DTMF codes to address a single station or a group of stations. Page is useful when waiting to receive a call from a specific station. A common Group Page code and individual Station codes should be agreed on in advance. You can select codes from the range 000 to 999 inclusive.

Unlike DTSS, Page offers the added benefit of identifying who called you. The calling station's code appears on the target transceiver's display. If called with an individual Station code, that station's code appears; if called with a Group code, the Group code appears. This characteristic of Page helps reduce the activity level on a frequency when operators are temporarily absent from their stations. There is no longer a need for repeated calls when your target station is not listening. On return to his or her operating position, their transceiver display will show your Station code. They will know immediately that you called.

PAGE CODE MEMORY

The transceiver has 11 Page code memories in total.

A	Stores your Station code.
0	Stores the calling station's code. The transceiver automatically stores this code while in Receive. You also can use the stored code to respond to the other station.
1 to 9	Stores Group codes or Station codes that you want to call.

STORING PAGE CODES

Be aware that audible DTMF tones from other transceivers near you may be picked up by your MC-45DM/DME or TH-7 microphone element. If so, this could prevent the following function from working correctly. To save the desired Page codes, use the following procedure:

- 1 Press **[DTSS] (1 s)** to switch ON Page.
 - "PAG" appears when the Page function is ON.
- 2 Press **[F], [DTSS]** to activate Code Select.
 - "P zzz" appears where "zzz" is the code stored in the currently selected memory. "---" indicates no codes have been stored previously.
 - The small Page memory "P" and "PAG" start blinking. The number following the blinking "P" is the Page code memory number ranging from 0 to 9, and A.

3 Turn the Tuning control, or press microphone [UP]/[DWN], to select Page memory A.

- Alternatively, if your microphone is equipped with a DTMF keypad, the Page memory can be entered by using the keypad numeric keys including [A]. After entering the Page memory, the Page code stored in that memory appears. "----" appears when no code is stored. Jump to Step 5 below.

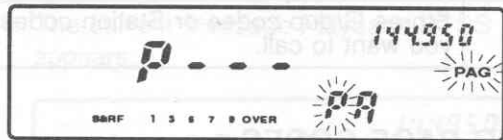

4 Press [DTSS].

- Pressing [DTSS] shifts the transceiver between Page code entry and Page code memory number modes.
- The large Page code "P" and "PAG" start blinking.

5 Select a 3-digit number (000 to 999) for your Station code by turning the Tuning control or by pressing microphone [UP]/[DWN].

- Alternatively, if your microphone is equipped with a DTMF keypad, the Page code also can be entered by using the keypad numeric keys. Press the 3 numeric keys in sequence for the code you want. Jump to step 7 below.



6 Press [DTSS].

- This stores your Station code in Page memory A.

7 Select Page memory 1 to 9 by turning the Tuning control, or by pressing microphone [UP]/[DWN].

- Alternatively, the keypad may be used as in Step 3. Jump to Step 9.

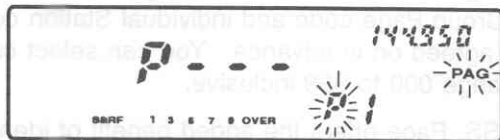

8 Press [DTSS].

9 Select the 3-digit Group code or Station code that you want to program.

- Again, the Tuning control or microphone can be used to enter the code as in Step 5. Press [DTSS].
- The keypad can be used as in Step 5.
- To store additional Group or Station codes, repeat Steps 7 to 9.



10 To restore the Display, press any button except [MR], [DTSS], microphone [UP]/[DWN], or the microphone numeric keys.

You can use the Group code or Station code immediately that was stored or selected last.

CALLING

- 1 Tune to the prearranged frequency.
- 2 Press **[DTSS]** (1 s).
 - "PAG" appears.
 - Repeating this step toggles the Page function ON and OFF.
- 3 Press **[F]**, **[DTSS]** to select Code Select.
 - The small Page memory "P" and "PAG" start blinking.
- 4 Turn the Tuning control, or press microphone **[UP]/[DWN]**, to select the Page memory where the desired Group code or Station code has been stored.
 - Alternatively, if your microphone is equipped with a DTMF keypad, the Page memory also can be entered by using the keypad numeric keys. Press the numeric key for the memory you want.
 - If you have not stored the desired Page code in a memory from 1 to 9, select memory 0 and store the Page code at this time.
- 5 To restore the Display, press any button except **[MR]** or **[DTSS]**.

- 6 Press and hold **[PTT]**.

- The Group code (or Station code) and your Station code are transmitted.



Pressing **[PTT]** automatically sends the Page data; however, pressing **[DTSS]** while **[PTT]** is held down, resends the data with the exception of European versions using the Tone function.

Note:

- ▶ When Page is ON, Scan cannot be used.
- ▶ When Page is ON, choosing the VFO, the Call channel, or a memory channel does not affect the Page status. Page remains ON.
- ▶ When Page is switched ON while DTSS is ON, DTSS is switched OFF automatically.

RECEIVING

- 1 Tune to the prearranged frequency.
- 2 Press [DTSS] (1 s).

- "PAG" appears.

You are ready to receive a call addressed with your Station code or a Group code. If no signal is received for more than 2 seconds after a Page has opened the squelch, the squelch then closes.

■ Receiving a Call with your Station Code

When a signal is received encoded with your Station code, the squelch opens and you hear an alert tone from the speaker. In addition, the Display shows "P0" and the calling station's code.



Press [PTT] while "P" is blinking to respond to the calling party.



■ Receiving a Call with a Group Code

When a signal is received encoded with the correct Group code, the squelch opens and you hear an alert tone from the speaker. In addition, the Display shows the received Group code and in which memory (1 to 9) that Group code has been stored.



Press [PTT] while "P" is blinking to respond to the calling party.

Note:

- ▶ "Err" appears on the Display if your transceiver fails to receive the Page code correctly.
- ▶ The microphone is inhibited while the Page code is transmitted.
- ▶ If Page and Tone Alert are ON, there is no speaker output except the alarm tone even if a signal is received with the correct Page code.

PAGE ANSWER-BACK

Page Answer-back is a confirmation signal consisting of your Station code sent by your station back to the station that initiated a Page call. The purpose is to inform the other station that your station received the Page call. Your station only sends the Answer-back signal if the station that paged you used a Page code that matched your Station code or Group code, and you have Page Answer-back turned ON.

- 1 Press **[REV] + POWER ON** to enter Menu B.
- 2 Select Menu No. 71 {page 24}.
 - The current Page Answer-back status appears.



- 3 Select a status.
 - OFF: No answer-back signal sent.
 - ON: Answer-back signal sent under conditions described above.
 - Default: OFF
- 4 Exit Menu B.

PAGE CODE AND REPEATERS

Pressing **[PTT]** transmits the Page code after a short delay. This delay helps avoid losing Page data when using repeaters with long response times that may miss receiving a portion of the Page code.

The delay time is 350 ms during simplex operation.

When using a transmit offset or a split frequency, you can change 350 ms (default) to 550 ms.

- 1 Press **[REV] + POWER ON** to enter Menu B.
- 2 Select Menu No. 53 {page 24}.
 - The current Delay Time appears.



- 3 Select a time value.
 - The times available are 350 or 550 ms.
 - Default: 350 ms
- 4 Exit Menu B.

Note: Page cannot be used with some repeaters.

LOCKING-OUT CODES

The following explains how to inhibit the transceiver from receiving specific Page codes. Although the codes are locked-out from the receiver, the transmitter still transmits a Page on the locked out channels.

- 1 Press **[DTSS]** (1 s).
 - "PAG" appears.
- 2 Press **[F]**, **[DTSS]** to select Code Select.
 - The small Page memory "P" and "PAG" start blinking.
- 3 Turn the Tuning control, or press microphone **[UP]/[DWN]**, to display the Page code you want to lock-out.
- 4 Press **[MR]**.
 - A "star" icon appears above the number to indicate the channel has been locked-out.



- 5 To restore the Display, press any button except **[MR]** or **[DTSS]**.
 - The lock-out "star" disappears.

Note: You cannot lock-out Page memory 0 or A.

AUTO PAGE CANCEL

After successfully paging another station, it is useful to turn OFF Page to eliminate sending a Page code each time you transmit. Auto Page Cancel handles this situation automatically when a station you called responds using the correct Page code to open your transceiver's squelch. On your next transmission, your transceiver then switches OFF your transceiver's Page function.

- 1 Press **[REV]** + **POWER ON** to enter Menu B.
- 2 Select Menu No. 51 {page 24}.
 - The current Auto Page Cancel status appears.



- 3 Select a status.
 - OFF: Does not affect Page status.
 - ON: Switches OFF Page after transmission.
 - Default: OFF
- 4 Exit Menu B.

OPEN PAGE

When both this function and Page are ON, any signal opens the squelch; however, if a correct Page code is received, the calling station's code appears on the Display. This feature is beneficial when you want to generally monitor activity on a frequency but you want to be especially sure not to miss a friend's call.

- 1 Press **[REV] + POWER ON** to enter Menu B.
- 2 Select Menu No. 52 {page 24}.
 - The current Open Page status appears.



- 3 Select a status.
 - OFF: Disables Open Page.
 - ON: Enables Open Page.
 - Default: OFF
- 4 Exit Menu B.

TONE ALERT

Tone Alert provides an audible alarm to indicate when someone is transmitting on the frequency you are monitoring.

Tone Alert is an effective partner with CTCSS, Page, or DTSS. When the correct signaling comes through, your transceiver beeps to alert you of an incoming call from a specific station.

ACTIVATING TONE ALERT

- 1 Tune to the prearranged frequency.
- 2 Activate CTCSS, Page, or DTSS if you want to use these together with Tone Alert.
- 3 Press **[F]**, **[SHIFT]**.
 - A "Bell" icon appears.
 - Each time this key combination is pressed, Tone Alert toggles ON and OFF.
- 4 When the correct signal is received, the transceiver rings 3 times, the "bell" icon begins blinking, and the Call Number increments.

- The Display shows the number of minutes and seconds elapsed after the last signal was received. After 59 minutes 59 seconds pass, the Display changes to 01.00 and continues counting. After 59 hours 59 minutes pass, counting stops. When the next signal is received, the time resets to 00.00 and counting continues. Each time a new signal is received, the time resets to 00.00.
 - The Call Number records the number of calls received to a maximum of 99.
 - The alarm tone can be changed if you prefer {page 87}.
- 5 When the "bell" icon is blinking, exit Tone Alert by pressing **[PTT]**.

Note:

- ▶ APO turns OFF the power if no key entry is made for 24 hours even if Tone Alert is ON.
- ▶ If Tone Alert is ON, there is no speaker output except the alarm tone when a signal is received.
- ▶ For Tone Alert to function correctly with CTCSS, the incoming signal must be present for approximately 1 second.
- ▶ Tone Alert cannot be used simultaneously with Message Playback Control via DTSS {page 77}. Although both functions can be turned ON at the same time, Message Playback Control will not function.

CHANGING THE ALARM TONE

Depending on where your station is installed and the ambient noise at your station location, you may want to change the default alarm signal that sounds when Tone Alert detects an incoming call. You have a choice of 3 alarm signals that may be selected as follows.

- 1 Press **[F] (1 s)** to enter Menu A.
- 2 Select "Bell" {page 22}.
 - "Bell" starts blinking and the current alarm selection appears.

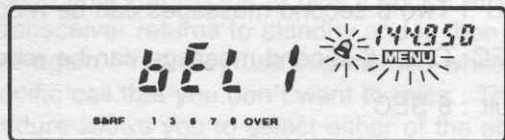

- 3 Select an alarm signal.
 - Bel 1: 3 telephone-style rings
 - Bel 2: 4 high-pitched double tones
 - Bel 3: musical tune
 - Default: Bel 1
- 4 Exit Menu A.

MESSAGE RECORDING

Although the Page/Tone Alert combination is useful to keep track of who called you and when, a better idea is to make an audio recording of a caller's message to you. The Message Record feature serves as a digital answering machine for your on-air activity in the same way tape recorders are commonly used to handle telephone messages.

ACTIVATING THE RECORD FUNCTION

Recording is started by switching ON CTCSS, DTSS, Page, or Tone Alert. When any of these functions are ON, the transceiver starts recording automatically when the squelch opens.

SELECTING THE RECORDING TIME

Additional flexibility has been provided by allowing you to tailor the total record time for your messages to match your requirements. You also have limited control over the quantity of messages that can be recorded.

1 Press **[REV] + POWER ON** to enter Menu B.

2 Select Menu No. 66 {page 24}.

- The current Record Time appears.



3 Select a timer value.

- 8 SEC : Two 8 second messages can be recorded.
- 16 SEC: One 16 second message can be recorded.
- Default : 8 SEC

4 Exit Menu B.

Note:

- ▶ If the squelch closes within the time selected in Menu B, recording stops, then the transceiver is on standby to record the next message when the squelch opens again.
- ▶ If the squelch remains open longer than the time selected in Menu B, recording stops when the maximum time is reached, then the transceiver is on standby to record the next message when the squelch opens again.

SELECTING THE RECORDING MODE

Sometimes you may want to continuously record the last audio that opened your transceiver squelch. This mode is similar to a tape that records continuously and automatically in an endless loop over previous messages, saving only the latest message. This method is useful while generally monitoring a frequency so you can hear a repeat of a call sign you may miss the first time.

At other times, you may want to record the first audio that opens your transceiver squelch, then save that message until you decide to play it back. After playback, the transceiver returns to standby and is then ready to record again. You may use this method while waiting for a specific call that you don't want to miss. The following procedure allows you to select either of the above methods.

- 1 Press [REV] + **POWER ON** to enter Menu B.
- 2 Select Menu No. 67 {page 24}.
 - The current Recording Mode appears.

3 Select the mode you prefer.

- 1: Continuous Record (Records automatically over previous messages.)
- 2: Record and Stop (Records to selected time and number of messages then stops.)
- Default: 1



4 Exit Menu B.

Note: When you select Continuous mode with 8 seconds Record Time, the following occurs:

- Message 1 contains the first message recorded (oldest) and has a duration of 8 seconds.
- Message 2 contains the most recent audio (newest) that opened the squelch.

PLAYBACK

Playback of the recorded messages always begins with the newest message first, i.e. the order of playback is Message 2 followed by Message 1. After playback, the transceiver returns to standby ready to record again when the squelch opens.

Press **[SHIFT] (1 s)**.

- The newest message is played back.
- After a double beep, the oldest message is played back.
- Repeat this step to hear the messages again or to interrupt the playback.

Note:

- ▶ *If the squelch opens during playback, the transceiver starts recording as soon as playback completes.*
- ▶ *While recording is in progress (squelch is open), playback is not possible. Attempting playback at this time produces an alarm beep.*

FULL DUPLEX OPERATION

Full Duplex allows you to have relaxed contacts that more closely resemble conversations that you might have with somebody in person. Since each party is transmitting on a different band, there is no necessity for either party to turn OFF their transmitter while listening, although it is a good habit to release the microphone PTT to prevent overheating of your transceiver. Each party can speak at any time since simultaneous Transmit and Receive is possible as if speaking on a telephone.

1 Press **[F]**, **[REV]** to select the Sub-band, and choose the receive frequency you intend to use.

- VFO mode must be selected to activate Full Duplex. Memory Recall and the Call channel cannot be used with Full Duplex.
- Full Duplex cannot be used if the current receive frequency is outside an Amateur band.

2 Press **[F]** (1 s) to enter Menu A.

3 Select "DUP" {page 22}.

- "DUP" starts blinking and the current DUP status appears.

4 Select a status.

- OFF: Selects Simplex/Half Duplex mode (consecutive Transmit/Receive).
- ON: Selects Full Duplex mode (simultaneous Transmit/Receive).
- Default: OFF



5 Exit Menu A.

- "DUP" remains ON if Full Duplex was selected.
- The receive frequency appears on the Sub-display, and the transmit frequency appears on the Main Display.
- The Memory → VFO Transfer function cannot be used while Full Duplex is ON.

Settings for CTCSS, DTSS, Page, Shift Offset, or Tone on the Main Band are unaffected by switching Full Duplex ON or OFF. The transmit frequency on the Main Band can be changed by turning the Tuning control, or pressing the microphone **[UP]** or **[DWN]** button, only while the Sub-band is receiving and **[PTT]** is released.

In general, the status of functions on the Display apply to the Main Band and not the Sub-band as long as Full Duplex is selected. That is, the status of functions applies to the Transmit band. One exception is when [F], [REV] is pressed. This allows you to receive on the Main Band as indicated by the Sub-display changing to the same frequency as the Main Band. However, pressing [PTT] immediately restores the Sub-band frequency on the Sub-display.

Certain functions cannot be used if Full Duplex is activated. The following chart identifies these functions:

Non-functional with Full Duplex ON	Page Ref.	Non-functional with Full Duplex ON	Page Ref.
Programmable Band Scan Limit Select	59	Channel Display	45
Programmable VFO Limit Select	33	Display Mode	65

PACKET OPERATION

One of the most exciting benefits of owning an FM transceiver nowadays is the ability to use it for VHF or UHF Packet radio. TM-251/451 transceivers are ideal, due to their small size, for operating Packet portable from a local mountaintop, for example, even if the transceiver is not permanently mounted as a mobile in your vehicle.

By using a small laptop computer to control any of the widely available Terminal Node Controllers (TNC), and interfacing the TNC to your transceiver via the DATA connector, you may be surprised at how compact and lightweight a digital station can be. Operating Packet while on the road from a campsite or hotel can be a great way to meet others with common interests when in a new area or city. Newcomers to digital communications will be surprised to discover what they have been missing.

Similarly, by connecting a home computer or dumb terminal to your TNC/transceiver assembly, you can become active on Packet with little further monetary investment. Connecting to one of the many stations with gateways to HF or satellite links can give you national and worldwide messaging capability from your station with nothing more than your VHF/UHF transceiver for the communications link.

ENABLING THE DATA CONNECTOR

After connecting the necessary Packet station equipment as explained in "ACCESSORY CONNECTIONS" on page 9, you must enable the DATA connector and select the correct baud rate before beginning to operate.

- 1 Press [REV] + **POWER ON** to enter Menu B.
- 2 Select Menu No. 57 {page 24}.
 - The current DATA connector status appears.
- 3 Select a status.
 - 1200: DATA connector enabled for 1200 bps operation.
 - 9600: DATA connector enabled for 9600 bps operation.
 - Default: 1200
- 4 Exit Menu B.

Note: When using 9600 bps, select only 5 kHz, 10 kHz, 15 kHz, or 20 kHz for the frequency step size.

MAINTENANCE

GENERAL INFORMATION

Your transceiver has been factory aligned and tested to specification before shipment. Under normal circumstances, the transceiver will operate in accordance with these operating instructions. All adjustable trimmers, coils and resistors in the transceiver were preset at the factory. They should only be readjusted by a qualified technician who is familiar with this transceiver and has the necessary test equipment. Attempting service or alignment without factory authorization can void the transceiver warranty.

When operated properly, the transceiver will provide years of service and enjoyment without requiring further realignment. The information in this section gives some general service procedures requiring little or no test equipment.

SERVICE

If it is ever necessary to return the equipment to your dealer or service center for repair, pack the transceiver in its original box and packing material. Include a full description of the problems experienced. Include your telephone number along with your name and address in case the service technician needs to call for further explanation while investigating your problem. Don't return accessory items unless you feel they are directly related to the service problem.

You may return your transceiver for service to the authorized KENWOOD Dealer from whom you purchased it or any authorized KENWOOD service center. A copy of the service report will be returned with the transceiver. Please do not send subassemblies or printed circuit boards. Send the complete transceiver.

Tag all returned items with your name and call sign for identification. Please mention the model and serial number of the transceiver in any communication regarding the problem.

SERVICE NOTE

Dear YL/OM,

If you desire to correspond on a technical or operational problem, please make your note short, complete, and to the point. Help us help you by providing the following:

- 1 Model and serial number of equipment
- 2 Question or problem you are having
- 3 Other equipment in your station pertaining to the problem
- 4 Meter readings
- 5 Other related information

CAUTION: Do not pack the equipment in crushed newspapers for shipment! Extensive damage may result during rough handling or shipping.

Note:

- ▶ Record the date of purchase, serial number and dealer from whom the transceiver was purchased.
- ▶ For your own information, retain a written record of any maintenance performed on the transceiver.
- ▶ When claiming warranty service, please include a photocopy of the bill of sale, or other proof-of-purchase showing the date of sale.

CLEANING

The keys, controls and case of the transceiver are likely to become soiled after extended use. Remove the controls from the transceiver and clean them with a neutral detergent and warm water. Use a neutral detergent (no strong chemicals) and a damp cloth to clean the case.

TROUBLESHOOTING

The problems described in this table are commonly encountered operational malfunctions. These types of difficulties are usually caused by improper hook-up, accidental incorrect control settings, or operator error due to incomplete programming, and are not caused by a circuit failure. Please review this table, and the appropriate section(s) of this Instruction Manual, before assuming your transceiver is defective.

Problem Symptom	Probable Cause	Corrective Action	Page Ref.
The transceiver will not power up after connecting a 13.8 V DC power supply and pressing [PWR] . Nothing appears on the Display.	1 The power cable is faulty.	1 Inspect the power cable. Confirm polarities are correct. Red: positive (+); Black: negative (-).	4,7
	2 The power cable is not connected securely.	2 Confirm the power connectors are pressed together and are locked in place by the locking tab.	4,7
	3 One or more of the power cable fuses are open.	3 Look for the cause of the blown fuse/fuses. After inspecting and correcting any problems, install new fuses with the same ratings.	6,8
The Display is too dim.	1 The Display Brightness needs changing.	1 Change the Display Brightness via Menu A.	64
	2 The Automatic Power Off function has timed out.	2 Press [PWR] twice.	63
	3 The supply voltage is too low.	3 The supply voltage requirement is 13.8 V DC \pm 15% (11.7 to 15.8 V DC). If the input voltage is outside this range, adjust your regulated power supply or recharge your battery.	5,7

Continued

Problem Symptom	Probable Cause	Corrective Action	Page Ref.
No sound comes from the speaker even though the VOL control is turned clockwise.	1 The squelch is closed.	1 Reset the squelch threshold.	28
	2 DTSS is ON ("DTSS" is visible); DTSS codes that you are receiving are different from the code set in your transceiver.	2 To monitor activity, press [DTSS] to turn OFF DTSS or press microphone [PF] . To contact stations using DTSS, review the "DTSS" section.	75,70
	3 Page is ON ("PAG" is visible); Page codes that you are receiving are different from those set in your transceiver.	3 To monitor activity, press [DTSS] (1 s) to turn OFF Page or press microphone [PF] . To contact stations using Page, review the "Page" section.	79
	4 If the TSU-8 CTCSS option is installed, CTCSS is ON ("CTCSS" is visible); CTCSS tones that you are receiving are different from the CTCSS tone frequency set in your transceiver.	4 To monitor activity, press [TONE/CTCSS] to turn OFF CTCSS or press microphone [PF] . To contact stations, review the "CTCSS" section.	74,70
	5 Tone Alert is ON ("Bell" icon is visible).	5 Press [F] , [SHIFT] to turn OFF Tone Alert.	86
Most buttons/keys and the Tuning control do not function.	1 The Lock function is ON.	1 Press [F] , [LOW] to turn Lock OFF.	62
	2 If microphone buttons/keys are not working, Microphone Lock is ON.	2 Slide the Lock switch on the rear of the microphone to unlock the microphone.	62

Continued

Problem Symptom	Probable Cause	Corrective Action	Page Ref.
The frequency cannot be changed by the Tuning control or the microphone [UP]/[DWN] buttons.	Memory Recall or the Call channel is selected.	Press [VFO].	32
Memory channels cannot be selected by turning the Tuning control or by pressing microphone [UP]/[DWN] when in Memory Recall.	<ol style="list-style-type: none"> 1 No data has been saved in any memory channels. 2 The Tuning control has been enabled to change frequency while Memory Recall is selected. 	<ol style="list-style-type: none"> 1 Store data in some memory channels. 2 Select Menu B, No. 56 and turn OFF the Tuning Enable function. 	39 41
Previously stored data is gone when the transceiver is powered.	The backup lithium battery voltage is too low.	Obtain a new battery from your dealer or a KENWOOD Service Center.	-
Memory Transfer copies data from a memory channel to the VFO correctly, but turning the Tuning control causes the frequency to jump to a different part of the band.	The frequency is jumping to be within the Programmable VFO limits.	Change the Programmable VFO limits.	33
Band Scan only scans a narrow range of frequencies; the entire band cannot be scanned.	You are actually using Programmable Band Scan because you have selected a VFO frequency within the limits for Programmable Band Scan.	Select a frequency that is outside the limits set for Programmable Band Scan, then press [VFO] (1 s).	59

Continued

Problem Symptom	Probable Cause	Corrective Action	Page Ref.
You cannot cancel Reverse.	Since Transmit Offset is ON, canceling Reverse would move the receive frequency out-of-band (or beyond programmed VFO limits).	Press [SHIFT] one or two times so neither "+" nor "-" are visible, then press [REV] .	49,51
You cannot access and use repeaters.	<ol style="list-style-type: none"> 1 The repeater requires a Tone frequency for access. 2 The repeater requires a Transmit Offset to be used. 3 Your antenna is not pointed accurately in the direction of the repeater. 	<ol style="list-style-type: none"> 1 Review "TONE ACCESS" and select the correct Tone. 2 Review "TRANSMIT OFFSETS" and select the correct offset. 3 Re-orient your antenna so it is beaming toward the repeater. 	<p>51</p> <p>48</p> <p>-</p>
You cannot transmit even though you press [PTT] .	<ol style="list-style-type: none"> 1 The microphone plug is not inserted completely in the Front Panel connector. 2 You have not selected the Main Band. 3 You have selected a transmit offset that places the transmit frequency outside the transmit band. 4 The Transmit Inhibit function is ON. 	<ol style="list-style-type: none"> 1 Turn OFF the power, ensure the microphone connector on the Front Panel has no foreign objects in it, then insert the microphone plug until the locking tab clicks in place. 2 Press [F], [REV] to select the Main Band. 3 Press [SHIFT] one or two times so neither "+" nor "-" are visible. 4 Turn OFF Transmit Inhibit via Menu B, No. 55. 	<p>9,14</p> <p>30</p> <p>49</p> <p>38</p>

Continued

Problem Symptom	Probable Cause	Corrective Action	Page Ref.
<p>The transceiver does not respond correctly after you press button combinations per instructions in this manual. Indicators appear on the Display that are not described in this manual.</p>	<p>1 Buttons are not being pressed in the correct manner.</p> <p>2 The microprocessor and its memory need resetting.</p>	<p>1 Review "CONVENTIONS FOLLOWED IN THIS MANUAL". Different functions are selected depending on how long a button is held down or whether a button is released before the next button is pressed, etc.</p> <p>2 First review "INITIALIZING MEMORY". After understanding what data will be lost, do a Partial Reset. If the problem remains, do a Full Reset.</p>	<p>2</p> <p>46</p>
<p>The Tuning control will not select the exact frequency desired.</p>	<p>The current frequency step needs to be changed.</p>	<p>Select a new frequency step via Menu A.</p>	<p>35</p>
<p>Memory Scan does not include some memory channels while scanning.</p>	<p>Some or all channels are locked-out as indicated by the "star" over the channel number when these channels are selected.</p>	<p>Select the memory channel to be unlocked, then press [LOW] (1 s) to unlock the channels that you want scanned.</p>	<p>58</p>
<p>The transceiver switches OFF for no apparent reason.</p>	<p>The Automatic Power Off function is ON.</p>	<p>Turn OFF the APO function via Menu A.</p>	<p>63</p>

Continued

Problem Symptom	Probable Cause	Corrective Action	Page Ref.
Packet operation results in no connects with other stations.	1 Physical connections between the transceiver, computer, and TNC are incorrect, or software settings in the TNC are wrong.	1 Re-check all connections using this manual, your TNC manual and your computer hardware manual as references.	10
	2 Different transmit and receive frequencies are being used. You must use the same transmit and receive frequency for packet.	2 Store the desired operating frequency in a memory channel using the "Simplex Memory Channels" procedure.	39
	3 The modulation level from the TNC is too low for the transceiver.	3 Adjust the TNC modulation level per instructions in your TNC manual.	-
	4 The transmitted signal is too weak.	4 Reorient your antenna or increase your antenna gain to improve your signal strength at the other station.	-
	5 CTCSS, DTSS, or Page are ON.	5 Turn OFF Tone, CTCSS, DTSS, and Page. Set the noise squelch threshold as you would for voice communications.	28

OPTIONAL ACCESSORIES

MC-45/45E

Multifunction Microphone



MC-45DM/45DME

Multifunction Microphone
with DTMF Keys



TSU-8

CTCSS unit

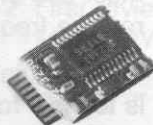

ME-1

Memory Expansion Unit

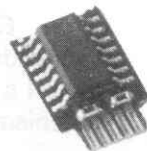

MB-12

Mobile Mounting Bracket

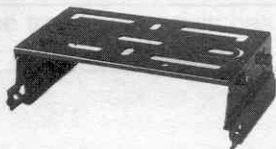

MB-201

Mobile Mounting Bracket



SP-41

Mobile Speaker



SP-50B

Communications Speaker



PS-33
Regulated DC Power Supply



PG-3G
DC Line Noise Filter
(High capacitance type)



PG-3B
DC Line Noise Filter



PG-2N
DC Power Cable



PG-5A
Data Cable



MJ-88
Microphone Plug Adaptor



MJ-89
Modular Plug Microphone Switch



TH-7
144/430 MHz FM
Dual Bander



INSTALLING OPTIONS

OPENING THE TRANSCEIVER

- 1 Turn off the power to the transceiver.
- 2 Remove the 2 screws from the upper cover, then lift up the rear of the cover to remove it.
 - Five tabs hold the front and sides of the upper cover.

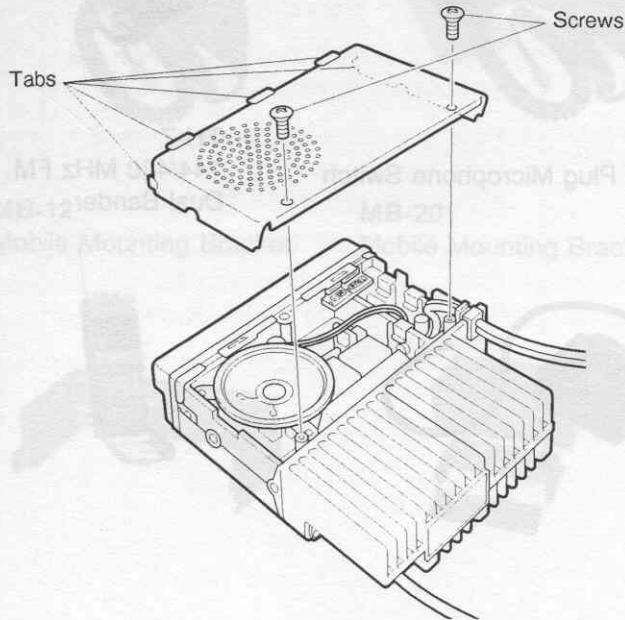

INSTALLING THE TSU-8 CTCSS UNIT

- 1 Open the transceiver.
- 2 Hold the plastic tab on the TSU-8 unit with the large IC facing upward, and insert the connector on the TSU-8 unit into the 8-pin connector labeled "TSU-8".

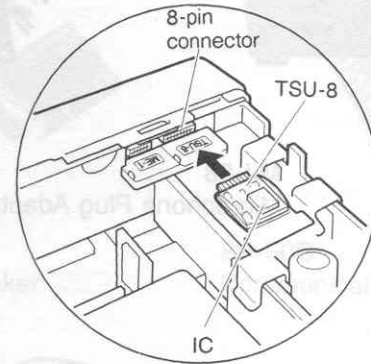

- 3 Replace the upper cover by inserting the tabs on the front and sides of the cover first, then lowering the rear of the cover.
- 4 Tighten the 2 screws.

INSTALLING THE ME-1 EXPANSION MEMORY UNIT

- 1 Open the transceiver {page 104}.
- 2 Hold the ME-1 unit with the large IC facing upward and insert the connector on the ME-1 unit into the 5-pin connector labeled "ME-1".

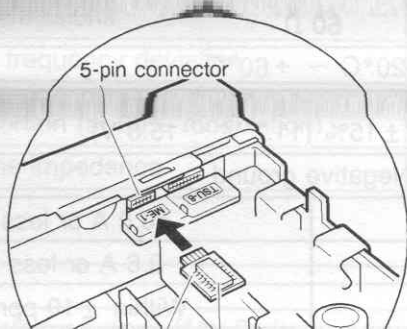

SPECIFICATIONS

General

		TM-251A/251E	TM-451A/451E
Frequency range	Main band	144.000 ~ 147.995 MHz ¹	438.000 ~ 449.995 MHz ³
	Sub-band (receive)	438.000 ~ 449.995 MHz ²	144.000 ~ 147.995 MHz ⁴
Mode	F3E		
Antenna impedance	50 Ω		
Usable temperature range	-20°C ~ +60°C		
Power supply	DC 13.8 V ± 15% (11.7 V ~ 15.8 V)		
Grounding method	Negative ground		
Current	Transmit (max.)	11.0 A or less	10.0 A or less
	Receive (no signal)	0.6 A or less	0.6 A or less
Frequency stability	Main band	Within ± 10 ppm	Within ± 10 ppm
	Sub-band (receive)	Within ± 10 ppm	Within ± 10 ppm
Dimensions (W × H × D) (projections not included)	140 mm × 40 mm × 160 mm		
Weight	1 kg		

¹ TM-251E: 144.000 ~ 145.995 MHz

² TM-251E and TM-251A (General): 430.000 ~ 439.995 MHz

³ TM-451E and TM-451A (General): 430.000 ~ 439.995 MHz

⁴ TM-451E: 144.000 ~ 145.995 MHz

Transmitter

		TM-251A/251E	TM-451A/451E
Power output	High	50 W	35 W
	Mid	Approx. 10 W	Approx. 10 W
	Low	Approx. 5 W	Approx. 5 W
Modulation		Reactance	
Spurious emissions		-60 dB or less	
Maximum frequency deviation		± 5 kHz	
Audio distortion (at 60% modulation)		3% or less	
Microphone impedance		600 Ω	

Receiver

Circuitry	Double conversion superheterodyne
Intermediate frequency (1st/ 2nd)	45.05 MHz/ 455 kHz
Sensitivity (12 dB SINAD)	0.16 μ V or less
Selectivity (-6 dB)	12 kHz or more
Selectivity (-60 dB)	28 kHz or less
Squelch sensitivity	0.1 μ V or less
Audio output (8 ohms, 5% distortion)	2 W or higher
Audio output impedance	8 Ω

GLOSSARY

APO (Automatic Power Off)

A function that automatically turns OFF the transceiver after some period of inactivity.

Auto Page Cancel

A function that automatically switches OFF the Page function after Page codes have been transmitted. The purpose is to avoid sending Page codes at the start of every transmission.

Automatic Transmit Offset

This function is for repeater users. It automatically selects the correct transmit frequency offset (both direction and amount) according to established band plans.

Autopatch

A service available widely in the U.S.A. and Canada that allows portable or mobile stations to access the public telephone network by connecting through a local repeater. Telephone numbers are sent via DTMF signals by using the microphone DTMF keypad. Only non-commercial communication is authorized.

Band Scan

A function that monitors sequentially all frequencies in a single band. See "Scan".

Beep Tone

A selectable function that generates a tone each time a button is pressed to provide audible confirmation that the button was actually pressed.

Call channel

A frequency intended for establishing contact with other stations. A microphone key is dedicated to the Call channel so the frequency can be recalled quickly.

Call/Memory Scan

A function that allows alternate monitoring of the Call channel and the current memory channel. The current memory channel is the memory channel selected or used last. See "Scan".

Call/VFO Scan

A scan function that allows alternate monitoring of the Call channel and the current VFO frequency. The current VFO frequency is the frequency selected or used last while in VFO mode. See "Scan".

Channel Display

A function that shows only the memory channel number on the display instead of both the frequency and the memory channel number.

CO (Carrier-operated) Scan

When scanning, scan stops at all carriers received and resumes 2 seconds after the carrier stops.

CTCSS (Continuous Tone Coded Squelch System)

Also referred to as Tone Squelch. A method of receiver squelch control that uses a subaudible tone superimposed by the transmitter on the transmitted signal. Only signals received with a subaudible tone that matches the tone selected at the receiver can open the receiver squelch.

CTCSS frequency

The subaudible frequencies used by CTCSS.

Default settings

The values selected for VFO frequency, Call channel frequency, Frequency Step, etc. by the transceiver after it is reset. All transceivers are shipped from the factory with default settings.

Display Mode

This function allows you to customize how the information that appears on the Display is presented.

DTMF (Dual Tone Multi-Frequency) signal

A signal created by combining two discrete audio frequencies. Generally used for sending digits for repeater control or Autopatch applications.

DTSS (Dual Tone Squelch System)

A squelch control system that relies on a burst of data from the transmitter to open the receiver squelch. Only when the transmitted code matches the code programmed in the receiver will the squelch open.

DTSS Transmit Delay

The delay intentionally introduced at the transmitter to delay transmission of DTSS codes after [PTT] is pressed. The delay can improve the reliability of DTSS when communicating with a receiver with slow response time.

Frequency step

The size of frequency change produced by turning the Tuning control one position or pressing the microphone [UP] or [DWN] button one time while in VFO mode.

Full Duplex

Full Duplex mode allows simultaneous transmit and receive communication using the Main Band for transmitting and the Sub-band for receiving.

Group code

When using Page, a group will commonly agree on a single code that will be used for calls targeted for all members. This code is the Group code. See "Station code".

Hang Time

See Squelch Hang Time.

Keypad

The collection of keys on the microphone used to send DTMF tones.

Locked-out channel

An electronically marked memory channel that will be skipped during Memory Scan. This is a quick way to configure your Memory Scan without actually erasing data from memory channels that you may want to keep.

Main Band

A band on which this transceiver is capable of receiving or transmitting. See Sub-band.

Memory channel

A "storage" location where you record an operating frequency and many other associated parameters for quick recall later. Normally, all commonly used frequencies including those of local repeaters would be saved in memory channels to eliminate manually selecting frequently-used frequencies.

Memory Recall

A function that fetches a previously saved operating frequency and associated data. See "Memory channel".

Memory Scan

A function that monitors sequentially all programmed memory channels that are not locked-out. See "Scan".

Memory Storage

A function that saves an operating frequency and associated data into a memory channel. See "Memory channel".

Memory → VFO Transfer

A function that records the current memory channel data in the VFO then selects VFO mode. This transfer action does not affect the data stored in the memory channel.

Menu Set-up

This is a newer term introduced with the creation of a Menu system for configuring transceiver features. Menu Set-up allows functions to be turned ON or OFF, or values to be set, through software rather than physical buttons or controls. Once you learn how to access the Menu, the standardized method of configuring features simplifies operation.

Message Recording

A function that allows audio recording of received signals for playback at a later time.

Microphone PF (Programmable Function) keys

Keys located on the microphone that can have transceiver functions assigned to them. Key assignments can be changed as necessary.

Microphone Lock

A function that disables most keys and buttons on the microphone.

Monitor

A function that overrides any squelch systems being used so activity on a frequency can be heard. This is handy to quickly listen to a frequency without actually changing the squelch setting or disabling the squelch system.

Non-standard offset

Refers to a transmit frequency offset used to access repeaters that is some value or direction other than that stipulated by existing band plans for a particular region. See "Transmit offset".

Open Page

When used in conjunction with Page, all signals received will open the receiver squelch. However, for signals encoded with a Page code, the calling station's Page code appears on the target transceiver's display.

Packet

This transceiver is equipped with a connector on the Rear Panel designed specifically for Packet operation. Packet is a data communications mode used to exchange digital information that is typically created using a personal computer. In other words, Packet provides a method to link computers together via radio.

Page

A function that allows one station to signal another by sending a transmission encoded with a Page code that only opens the squelch of a receiver with the same code selected. The calling station's code appears on the target station's display after a successful Page.

Page code memory

A memory channel dedicated to storing only Page codes. See "Page".

Page Transmit Delay

The delay intentionally introduced at the transmitter to delay transmission of Page codes after **[PTT]** is pressed. The delay can improve the reliability of Page when communicating with a receiver with slow response time.

Programmable Band Scan

A function that monitors sequentially all frequencies within the programmable limits set by the user in a single band. See "Scan".

PTT (Push-to-talk)

Refers to the non-latching switch on the microphone that changes the transceiver from Receive to Transmit mode.

QSO

Refers to a contact between two Amateur stations.

Repeater

A station, usually installed in a central location at a high elevation, designed to receive and re-transmit signals. The purpose of a repeater is to increase the receive and transmit range of stations able to access the repeater.

Reset (initialization)

The act of restarting the transceiver microcomputer. Depending on the type of reset done, some or all memory may be erased and set to default values. A reset can be done as a last resort when the transceiver appears to be malfunctioning.

Reverse

A function that switches the transmit and receive frequencies.

Scan

The general term for several functions that allow a series of frequencies or memories to be monitored sequentially and automatically without intervention by the operator.

Simplex channel

Refers to a communications channel where the receive and transmit frequencies are equal.

S-meter Squelch

A squelch method where the operator selects the minimum S-meter signal strength a received signal must have before it will be heard.

Split channel

Refers to a communications channel where the receive and transmit frequencies are not equal.

Squelch

A function that automatically mutes a receiver's speaker output when no receive signal is present.

Squelch Hang Time

The time that the squelch remains open after a carrier drops out.

Squelch threshold level

The receive level at which a receiver's speaker output is muted. This level is usually adjustable, either manually or automatically by the transceiver microcomputer.

Standard offset

Refers to a transmit frequency offset used to access repeaters that is equal to the amount and direction stipulated by existing band plans for a particular region. See "Transmit offset".

Station Page code

When using Page, each station must be assigned a unique code that no other station uses. This is your Station code. Only the squelch of the targeted station will open when a transmission with this Station code is made. See "Group code".

Subaudible Tone

A low-frequency non-audible signal superimposed by a transmitter on a transmitted signal for the purpose of accessing some types of repeaters.

Sub-band

A band on which this transceiver is only capable of receiving. No transmit functions are possible on a Sub-band. See Main Band.

SWR (standing wave ratio)

An antenna that is not correctly matched in impedance with a transmission line and transmitter will reflect some portion of the transmitted signal back toward the transmitter. This causes a standing wave pattern to develop. The ratio of maximum to minimum voltage (VSWR) on the transmission line when such a condition exists is commonly referred to as the SWR.

TO (Time-operated) Scan

When scanning, scan stops at all carriers received and resumes after 5 seconds.

Tone Alert

A function that alerts an operator via a visual and audible alarm when the receiver squelch opens.

Tone frequency

See "Subaudible Tone".

TOT (Time-out Timer)

A function that automatically forces a transceiver from Transmit back to Receive after expiry of a timer.

Transceiver Lock

A function that disables most buttons and controls on the transceiver.

Transmit Inhibit

A function that stops a transceiver from transmitting. The function has no effect on the receiver or receive functions.

Transmit offset (shift)

All Amateur voice repeaters operate on separate transmit and receive frequencies. Transmit offset is the amount that a transmit frequency is different from a receive frequency. See "Transmit offset direction".

Transmit offset (shift) direction

Refers to the direction, either plus (+) or minus (-), that a transmit frequency is with respect to a receive frequency. Both the direction and amount of offset must be selected correctly to access a repeater. See "Transmit offset".

VFO (variable frequency oscillator) mode

The mode that allows any individual frequency to be selected within the range of the VFO only restricted by frequency step limitations. When in VFO mode, frequencies are selected using the Tuning control or the microphone [UP]/[DWN] buttons.

QUICK REFERENCE GUIDE

This guide assumes your transceiver is currently in VFO mode.

Function	Menu	Action	Page
Power ON/OFF	—	[PWR]	28
AM/FM Mode ¹	A "spade"	Menu Set-up	31
Automatic Power Off (APO)	A "APO"	Menu Set-up • After APO turns transceiver OFF: [PWR]	63
Autopatch	—	See DTMF and DTMF Memory	53
Band Select	—	[F], [REV]	30
Beep Tone	A "BEEP"	Menu Set-up	64
Call Channel			44
• Store simplex	—	Select data → [F] → [CALL]	
• Store split	—	Select RX data → [F] → [CALL] (1 s) → Select TX data → [CALL]	45
• Recall	—	[CALL]	43
• Transfer (Call > VFO)	—	[CALL] → [F], [VFO]	42
• Assign PF4	—	[SHIFT] + POWER ON	70

Continued

Function	Menu	Action	Page
Channel Display	B No. 59	Menu Set-up	45
CTCSS • Select	—	[F], [TONE/CTCSS] → Tuning/[UP]/[DWN] → [TONE/CTCSS]	74
• ON/OFF	—	ON : [TONE/CTCSS], [TONE/CTCSS] OFF : [TONE/CTCSS]	74
DATA connector baud rate	B No. 57	Menu Set-up	93
Display Demonstration Mode	—	[DTSS] + POWER ON • Disable by a Partial or Full Reset.	66
Display Dimmer	A "DIM"	Menu Set-up	64
Display Mode	A "..."	Menu Set-up	65
DTMF • Transmit	—	[PTT] + Keypad	53
DTMF Memory • Store	B No. 65	Menu Set-up → Enter digits → [PF] → Enter [0] to [9]	54
• Confirm	B No. 65	Menu Set-up → [CALL] → Enter [0] to [9]	55
• Transmit	—	[PTT] + [PF] → Enter [0] to [9]	55

Continued

Function	Menu	Action	Page
DTSS • Store	—	[DTSS] → [F], [DTSS] → Tuning/[UP]/[DWN]/Keypad ² → [DTSS]	76
• Delay (split)	B No. 53	Menu Set-up	76
• ON/OFF	—	[DTSS]	75
• Message Playback Control	B No. 72	Menu Set-up	77
• Message Playback Control Code	B No. 73	Menu Set-up	78
Frequency • Step	A "STEP"	Menu Set-up	35
• Select	—	[VFO] → Tuning/[UP]/[DWN]	32
• Direct Entry	—	See Remote Control	71
Full Duplex	A "DUP"	Menu Set-up	91
Lock • Microphone	—	Microphone LOCK switch	62
• Transceiver	—	[F], [LOW]	62

Continued

Function	Menu	Action	Page
Memory			39
•Store simplex	—	Select data → [F] → Tuning/[UP]/[DWN] → [MR]	
•Store split	—	Select RX data → [F] → Tuning/[UP]/[DWN] → [MR] (1 s) → Select TX data → [MR]	40
•Recall	—	[MR] → Tuning/[UP]/[DWN] Direct Entry: See Remote Control	41
•Frequency Change	B No. 56	Menu Set-up	41
•Transfer (M > VFO)	—	[MR] → Tuning/[UP]/[DWN] → [F], [VFO]	42
•Erase	—	[MR] → Tuning/[UP]/[DWN] → [F] + [MR]	43
•Reset (Full)	—	[MR] + POWER ON	46
Menu A Set-up	—	[F] (1 s) → [VFO]/[MR] → Tuning/[UP]/[DWN] → [SHIFT]/[TONE/CTCSS]/[REV]/[DTSS]	22
Menu B Set-up	—	[REV] + POWER ON → [VFO]/[MR] → Tuning/[UP]/[DWN] → [SHIFT]/[TONE/CTCSS]/[REV]/[DTSS]	24
Message Recording			88
•Record Time	B No. 66	Menu Set-up	
•Record Mode	B No. 67	Menu Set-up	89
•Record ON/OFF	—	[TONE/CTCSS], [TONE/CTCSS] or [DTSS] or [DTSS] (1 s) or [F], [SHIFT]	88
•Playback	—	[SHIFT] (1 s)	90

Continued

Function	Menu	Action	Page
Microphone connector receive audio (RD)	B No. 58	Menu Set-up	71
Monitor Function			
• Select	—	Microphone [PF]	70
• Assign to PF1	—	[F] + POWER ON	70
Packet Operation	—	See DATA connector baud rate	93
Page			
• Store	—	[DTSS] (1 s) → [F], [DTSS] → Tuning/[UP]/[DWN]/Keypad ² (PA) → [DTSS] → Tuning/[UP]/[DWN]/Keypad ² (your code) → [DTSS] → Tuning/[UP]/[DWN]/Keypad ² (P1 to P9) → Tuning/[UP]/[DWN]/Keypad (target code) → [PTT]	79
• Call	—	[DTSS] (1 s) → [F], [DTSS] → Tuning/[UP]/[DWN]/Keypad (target memory) → [PTT] → [PTT]	81
• ON/OFF	—	[DTSS] (1 s)	79
• Answer-Back	B No. 71	Menu Set-up	83
• Code Lock-out	—	[DTSS] (1 s) → [F], [DTSS] → Tuning/[UP]/[DWN] → [MR] → [PTT]	84
• Auto Cancel	B No. 51	Menu Set-up	84

Continued

Function	Menu	Action	Page
• Open Page	B No. 52	Menu Set-up	85
• Delay (split)	B No. 53	Menu Set-up	83
Programmable Function(PF) Keys			
• Assign PF1	—	[PF] + POWER ON → Front Panel button ⁵ → [F] only: [TONE/CTCSS] + POWER ON	70
• Assign PF2	—	Microphone [MR] + POWER ON → Front Panel button ⁵	70
• Assign PF3	—	Microphone [VFO] + POWER ON → Front Panel button ⁵	70
• Assign PF4	—	[CALL] + POWER ON → Front Panel button ⁵	70
Remote Control	B No. 50	Menu Set-up	67
Repeater Access			
• TX Offset direction	—	[SHIFT]	49
• Auto TX Offset direction	A " - + "	Menu Set-up	49,50
• TX Offset amount	A " - + "	Menu Set-up	50
• Reverse ON/OFF	—	[REV]	51
• Tone select	—	[F], [TONE/CTCSS] → Tuning/[UP]/[DWN] → [TONE/CTCSS]	52
• Tone ON/OFF	—	ON: [TONE/CTCSS] OFF: [TONE/CTCSS](, [TONE/CTCSS]) ³	51

Continued

Function	Menu	Action	Page
• Transmit Hold (1750 Hz)	B No. 54	Menu Set-up • TM-251E/TM-451E only	53
Reset • Partial (VFO)	—	[VFO] + POWER ON	46
• Full (Memory)	—	[MR] + POWER ON	46
Scan • Scan Resume	A "CO"	Menu Set-up	57
• Memory Scan	—	Start: [MR] (1 s) → Tuning/[UP]/[DWN] Stop: [MR] ⁴	58
• Memory Lock-out	—	[MR] → Tuning/[UP]/[DWN] → [LOW] (1 s)	58
• Band Scan	—	Start: [VFO] (1 s) → Tuning/[UP]/[DWN] Stop: [VFO] ⁴	59
• Programmable Band Scan (Limits)	B Nos. 60 (L), 61 (U)	Menu Set-up	59
• Programmable Band Scan (Operate)	—	Start: Select frequency within limits → [VFO] (1 s) → Tuning/[UP]/[DWN] Stop: [VFO] ⁴	60
• Call/VFO Scan	—	Start: [VFO] → [CALL] (1 s) Stop: [VFO] ⁴	61

Continued

Function	Menu	Action	Page
• Call/Memory Scan	—	Start: [MR] → [CALL] (1 s) Stop: [MR] ⁴	61
Squelch • Noise (Threshold)	—	SQL control	28
• S-Meter	A "S.SQL"	Menu Set-up	29
• Squelch Hang Time Select	B No. 64	Menu Set-up	29
Time-Out Timer (TOT)	A "TOT"	Menu Set-up	38
Tone Alert • ON/OFF	—	ON: [F] , [SHIFT] OFF (before call): [F] , [SHIFT] OFF (after call): [PTT]	86
• Alarm Tone Select	A "BELL"	Menu Set-up	87
TX Inhibit	B No. 55	Menu Set-up	38
TX Power Output	—	[LOW]	37

Continued

Function	Menu	Action	Page
VFO			
• Select	—	[VFO]	32
• Programmable Tuning	B Nos. 62 (L), 63 (U)	Menu Set-up	33
• Reset (Partial)	—	[VFO] + POWER ON	46
Volume	—	VOL control	28

¹ Only on TM-251A/E with expanded receive coverage outside the Amateur bands.

² If using the microphone keypad, omit the next step.

³ With CTCSS unit installed.

⁴ Any button/key except microphone [UP], [DWN] or the keypad keys.

⁵ Except [F] or [PWR].