

KENWOOD

144/440 MHz FM DUAL BANDER

TM-733A

144/430 MHz FM DUAL BANDER

TM-733A

144/430 MHz FM DUAL BANDER

TM-733E

INSTRUCTION MANUAL

KENWOOD CORPORATION

©PRINTED IN JAPAN B62-0391-00(K,P,E,M) (MC)
95/12 11 10 9 8 7 6 5 4 3 2 1 94/12 11 10 9 8 7 6 5 4 3 2

THANK YOU

We are grateful you decided to purchase this **KENWOOD** FM transceiver. The TM-733 series of mobile transceivers were developed to satisfy the requirement for a compact rig that's simple to operate yet contains numerous sophisticated features. The dual band operation will be appreciated by hams who want access to VHF and UHF bands with a transceiver smaller than some single banders.

KENWOOD believes you will be satisfied with this product's quality and features.

PRECAUTIONS

Please observe the following precautions to prevent fire, personal injury, and transceiver damage:

- Do not transmit with high output power for extended periods. The transceiver may overheat.
- Do not modify this transceiver unless instructed by this manual or by some other approved **KENWOOD** communication.
- Do not expose the transceiver to long periods of direct sunlight or place the transceiver close to heating appliances.
- Do not place the transceiver in excessively dusty or humid areas, or on unstable surfaces.
- If an abnormal odor or smoke is detected coming from the transceiver, turn OFF the power immediately. Contact a **KENWOOD** service station or your dealer.
- The transceiver is designed for a 13.8 V power source. Never use a 24 V battery to power the transceiver.
- Ensure the Front Panel of the transceiver is installed correctly to prevent the panel from falling. Refer to pages 17 and 111.

CONTENTS

FEATURES	1	BUTTON FUNCTION DISPLAY	24
ACCESSORIES	1	Basic State Display Labels	24
CONVENTIONS FOLLOWED IN THIS MANUAL	2	Labels After Pressing [F]	24
PREPARATION FOR MOBILE OPERATION	3	Labels After Pressing [F] for More than 1 Second	24
MOBILE INSTALLATION	3	Programmable Memory Recall Labels	24
Installation Example	3	CONFIRMATION BEFORE OPERATION	25
DC POWER CABLE CONNECTION	4	FRONT PANEL	25
Replacing Fuses	5	REAR PANEL	25
ANTENNA CONNECTION	6	RECEIVING	26
PREPARATION FOR FIXED STATION OPERATION	7	SWITCHING POWER ON/OFF	26
DC POWER SUPPLY CONNECTION	7	VOLUME ADJUST	26
Replacing Fuses	8	SQUELCH ADJUST	27
ANTENNA CONNECTION	8	Noise Squelch	27
ACCESSORY CONNECTIONS	9	Automatic Squelch	27
EXTERNAL SPEAKERS	9	S-Meter Squelch	28
Receive Audio Switching	9	Squelch Hang Time	28
MICROPHONE	10	RD Output Squelch Control	29
PACKET EQUIPMENT	10	BAND SELECT	29
DATA Connector Pinout	11	VHF/VHF Operation	30
GETTING ACQUAINTED	12	UHF/UHF Operation	30
FRONT PANEL	12	Transmit Band Lock	31
REAR PANEL	18	Blanking a Band Display	32
MICROPHONE	19	VFO MODE	32
DISPLAY	20	SELECTING FREQUENCIES	33
		Tuning Control	33
		Microphone [UP]/[DWN] Buttons	33
		Programmable VFO	33
		AM/FM MODE (SOME VERSIONS ONLY)	34

FREQUENCY STEP SIZE	35	STORING DATA IN PROGRAMMABLE	
1 MHz/ 10 MHz Functions	36	MEMORY	53
Changes in Displayed Frequencies	37	USING PROGRAMMABLE MEMORY	54
TRANSMITTING	39	RECALLING PROGRAMMABLE MEMORY	
MICROPHONE PTT	39	CHANNELS (VFO MODE).....	54
SELECTING OUTPUT POWER	39	RECALLING PROGRAMMABLE MEMORY	
TIME-OUT TIMER (TOT)	40	CHANNELS (PROGRAMMABLE MEMORY	
MEMORY CHANNELS.....	41	CHANNEL MODE)	55
VHF/UHF MEMORY CHANNEL RATIO.....	41	Direct Method	55
STORING DATA IN MEMORY	42	Tuning Control Method	55
Simplex Memory Channels	42	ERASING PROGRAMMABLE MEMORY	
Split Memory Channels.....	43	CHANNELS (VFO MODE ONLY)	56
RECALLING MEMORY CHANNELS.....	44	RESETTING PROGRAMMABLE MEMORY	
MEMORY → VFO TRANSFERS	44	(VFO MODE ONLY)	56
ERASING MEMORY CHANNELS.....	45	OPERATING THROUGH REPEATERS.....	57
CALL CHANNEL	45	TRANSMIT OFFSETS.....	57
Recalling the Call Channel	45	SELECTING OFFSET DIRECTION.....	58
Changing Call Channel Contents (Simplex)...	46	AUTOMATIC TRANSMIT OFFSET	58
Changing Call Channel Contents (Split)	47	U.S.A. and Canada Versions.....	58
CHANNEL DISPLAY FUNCTION.....	47	European Versions.....	59
INITIALIZING MEMORY	49	Canceling Automatic Offset	59
Partial Reset - Single Band.....	49	REVERSE FUNCTION.....	59
Partial Reset - Both Bands	49	Automatic Simplex Checker (ASC)	60
Full Reset excluding Programmable Memory..	50	TONE ACCESS.....	60
Full Reset including Programmable Memory..	50	Selecting a Tone Frequency.....	61
PROGRAMMABLE MEMORY (PM).....	51	European Versions.....	62
PROGRAMMABLE INFORMATION.....	51	DUAL TONE MULTI-FREQUENCY (DTMF)	
Memory Channel Storage	51	FUNCTIONS.....	62
Programmable Memory Channel Storage.....	51	Making DTMF Calls	62
APPLICATION EXAMPLES.....	52	Microphone Keypad Confirmation Tones.....	63
		Storing DTMF Numbers for the Automatic	
		Dialer.....	63

Confirming Stored DTMF Numbers.....	64	DISPLAY DIMMER.....	78
Transmitting Stored DTMF Numbers (Automatic Dialer).....	64	Auto Dimmer Change.....	79
Autopatch (U.S.A. and Canada Versions)	65	DISPLAY DEMONSTRATION MODE (SHOW-OFF MODE).....	79
SCAN.....	66	REMOTE CONTROL.....	80
SCAN RESUME METHODS.....	67	ACTIVATING REMOTE CONTROL MODE.....	80
Time-Operated Scan.....	67	REMOTE CONTROL FUNCTIONS.....	81
Carrier-Operated Scan.....	67	ADDITIONAL REMOTE FUNCTIONS	82
SELECTING SCAN RESUME METHOD.....	67	Configuring the PF Keys	82
MEMORY SCAN.....	68	Monitor Function.....	83
Locking-Out Memory Channels.....	68	Enter Function.....	83
BAND SCAN	69	REMOTE FUNCTIONS USING TH-7	83
PROGRAMMABLE BAND SCAN.....	70	KEYPAD DIRECT ENTRY.....	83
Setting Scan Limits	70	Frequency Entry.....	84
Confirming the Programmable Limits	70	Memory Channel or Tone/CTCSS Number Entry.....	85
Using Programmable Band Scan.....	70	CONTINUOUS TONE CODED SQUELCH SYSTEM (CTCSS).....	87
MHz SCAN.....	71	SELECTING CTCSS FREQUENCIES	87
CALL/VFO SCAN.....	71	USING CTCSS.....	87
CALL/MEMORY SCAN	72	Automatic Tone Frequency ID.....	88
PROGRAMMABLE MEMORY SCAN.....	72	DUAL TONE SQUELCH SYSTEM (DTSS)	89
AUXILIARY FUNCTIONS.....	73	STORING DTSS CODES.....	89
AUTOMATIC BAND CHANGE (A.B.C.).....	73	Using the Tuning Control or Microphone [UP]/[DWN].....	89
ADVANCED INTERCEPT POINT (AIP).....	74	Using the Microphone DTMF Keypad (U.S.A./Canada Versions).....	90
MUTE	74	ACTIVATING DTSS.....	91
LOCK	75	DTSS AND REPEATERS.....	91
Transceiver Lock.....	75		
Microphone Lock.....	76		
All Lock	76		
AUTOMATIC POWER OFF (APO).....	76		
BEEP FUNCTION.....	77		
Frequency Readout by Beeps.....	77		

PAGE.....	92	INSTALLING OPTIONS.....	110
OVERVIEW.....	92	OPENING THE TRANSCEIVER CASE.....	110
PAGE CODE MEMORY.....	92	INSTALLING THE TSU-8 CTCSS UNIT.....	110
STORING PAGE CODES.....	93	REMOVING THE DATA CONNECTOR	
Using the Tuning Control or		COVER.....	111
Microphone [UP]/[DWN].....	93	DETACHABLE FRONT PANEL KITS	
Using the Microphone DTMF Keypad		(DFK-3B, DFK-4B, DFK-7B).....	112
(U.S.A./Canada Versions).....	94	Installation.....	112
CALLING.....	94	Installation Examples.....	113
RECEIVING.....	95	SPECIFICATIONS.....	115
Receiving a Call with your Station Code.....	95		
Receiving a Call with a Group Code.....	96		
PAGE CODE AND REPEATERS.....	97		
LOCKING-OUT CODES.....	97		
AUTO PAGE CANCEL.....	98		
OPEN PAGE.....	98		
TONE ALERT.....	99		
ACTIVATING TONE ALERT.....	99		
CHANGING THE ALARM TONE.....	100		
PACKET OPERATION.....	101		
1200/9600 bps OPERATION.....	101		
MAINTENANCE.....	102		
GENERAL INFORMATION.....	102		
SERVICE.....	102		
SERVICE NOTE.....	103		
CLEANING.....	103		
TROUBLESHOOTING.....	104		
OPTIONAL ACCESSORIES.....	108		

FEATURES

- Introduces Programmable Memory channels that store much more information than regular memory channels to preserve an entire operating environment for quick recall.
- Labels for multi-function buttons change resulting in a more user-friendly transceiver.
- Front Panel detaches easily from the Main Unit via a single slide switch for simple remote mounting.
- Full transceive capability on one frequency pair while simultaneously monitoring another receive frequency on the other band. Simultaneous receive configurations include VHF/UHF, VHF/VHF, and UHF/UHF.
- Automatic Simplex Checker (ASC) function that advises when direct simplex communication can be used instead of a repeater.
- Dedicated Front Panel DATA connector for 1200 bps or 9600 bps Packet operation.
- Advanced Intercept Point (AIP) function for fighting intermodulation problems.

ACCESSORIES

Accessory	Part Number	Quantity
Microphone		
U.S.A./Canada, General ¹	T91-0517-XX	1
Europe, General ¹	T91-0516-XX	1
Microphone hanger		
U.S.A./Canada	J20-0319-XX	1
Microphone hanger screw		
U.S.A./Canada	N46-3010-XX	2
DC power cable	E30-2111-XX	1
Transceiver fuse, 15 A	F51-0017-XX	1
Mounting bracket	J29-0436-XX	1
Mounting bracket screws		
Self-tapping screw	N09-0335-XX	4
Washer	N15-1050-XX	4
Hexagon screw	N09-2177-XX	4
Wrench	W01-0414-XX	1
Warranty card		
U.S.A./Canada, Europe ²	-	1
Instruction manual	B62-0391-XX	1

¹ Excluding some General and European versions.

² Excluding some European versions.

CONVENTIONS FOLLOWED IN THIS MANUAL

The writing conventions described below have been followed to simplify instructions and avoid unnecessary repetition. This format is less confusing for the reader. Reviewing the following information now will reduce your learning period. That means less time will be spent reading this manual; more time will be available for operating.

Note:

- ◆ *Basic procedures are numbered sequentially to guide you step-by-step. Additional information pertaining to a step, but not essential to complete the procedure, is provided in bulleted form following many steps for further guidance.*
- ◆ *Most procedures require that you enter a final key stroke that acts as a terminator for the procedure. You can, if you prefer, wait for approximately 10 seconds rather than enter this final key entry.*

Instruction	What to do
Press [KEY] .	Press and release KEY .
Press [KEY1]+[KEY2] .	Press and hold KEY1 down, then press KEY2 .
Press [KEY1], [KEY2] .	Press KEY1 momentarily, release KEY1 , then press KEY2 .
Press [KEY]+ POWER ON .	With transceiver power OFF, press and hold KEY , then turn ON the transceiver power by pressing [PWR] .
Press [KEY1]+[KEY2]+ POWER ON .	With the transceiver power OFF, press and hold both KEY1 and KEY2 down, then turn ON the transceiver power by pressing [PWR] .
Press [F] (1 s) .	Press and hold the Function key until the "F" indicator on the Display begins blinking.
Press [KEY] (1 s) .	Press and hold KEY until the function begins.
Press [F], [KEY] (1 s) .	Press [F] momentarily, release [F] , then press and hold KEY for 1 second or longer.

PREPARATION FOR MOBILE OPERATION

When operating mobile, do not attempt to configure your transceiver while driving because it is simply too dangerous. Stop the car first, then make the necessary changes. Also, be aware of local laws pertaining to the use of headphones/headsets while driving on public roads. If in doubt, do not wear headphones while mobiling.

MOBILE INSTALLATION

Install the transceiver in a safe, convenient position inside your vehicle that minimizes danger to your passengers and yourself while the vehicle is in motion. For example, consider installing the transceiver under the dash in front of the passenger seat so that knees or legs will not strike the radio during sudden braking of your vehicle. Try to pick a well-ventilated location that is shielded from direct sunlight. Leave sufficient space behind the Rear Panel for the transceiver fan to exhaust warm air.

■ Installation Example

- 1 Install the mounting bracket using the supplied flat washers and self-tapping screws. There are 4 washers and 4 screws supplied.
 - The bracket can be mounted with the bracket opening for the transceiver facing down for underdash mounting, or with the opening facing up. Study the accompanying diagram to determine the best installation method for your situation.

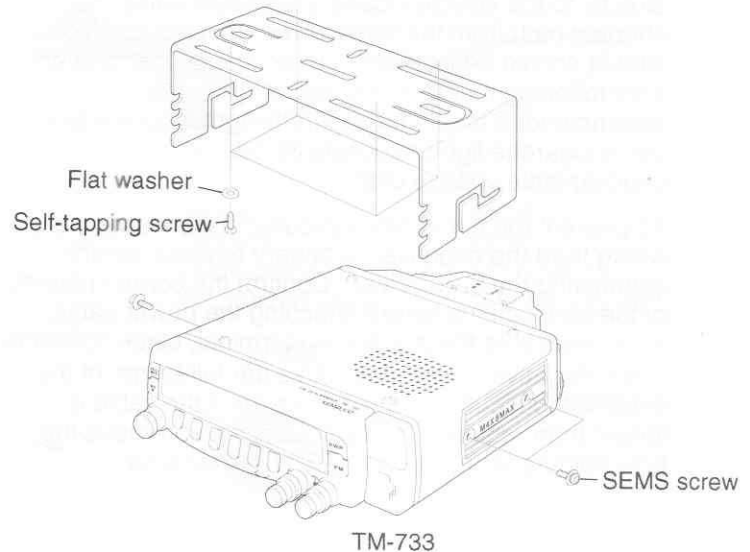

- 2 Position the transceiver in the bracket to determine the best viewing angle.
- 3 Insert and tighten the supplied hexagonal SEMS screws and washers. There are 2 screws and 2 washers supplied for each side of the bracket.
 - Double check that all hardware is tightened to prevent vehicle vibration from loosening the bracket or transceiver.

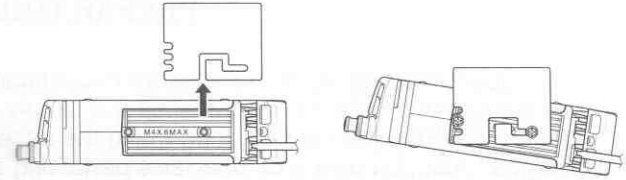

DC POWER CABLE CONNECTION

Route the DC power cable supplied with the transceiver directly to the vehicle's battery terminals using the shortest path from the transceiver. If using a noise filter, it should be installed with an insulator to prevent it from touching metal on the vehicle. It is not recommended to use the cigarette lighter socket since some cigarette lighter sockets introduce an unacceptable voltage drop.

To prevent the risk of short circuits, disconnect other wiring from the negative (-) battery terminal before connecting the transceiver. Confirm the correct polarity of the connections before attaching the power cable; red connects to the positive (+) terminal, black connects to the negative (-) terminal. Use the full length of the cable without cutting off excess even if the cable is longer than required. In particular, never remove the fuse holders from the cable. After completing

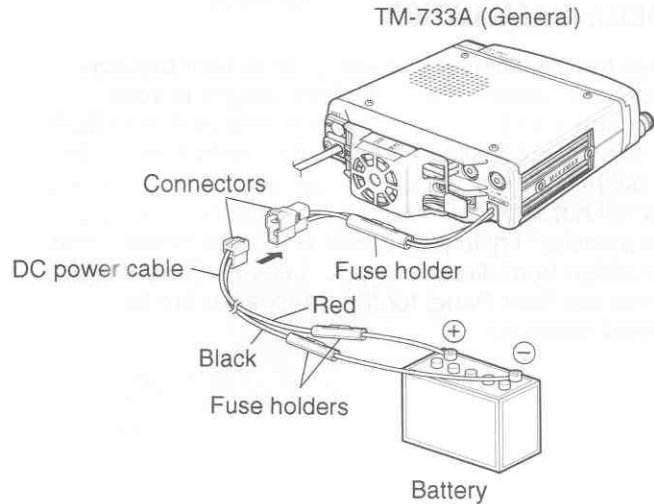

transceiver connections to the battery, then reconnect any wiring removed from the negative terminal.

If the power cable must be routed through a hole in the vehicle chassis or body, for example in the firewall at the front of the passenger compartment, use a rubber grommet to protect the cable from abrasion. The entire length of the cable must be dressed so it is isolated from heat and moisture. After the cable is in place, wind heat-resistant tape around the fuse holder to protect it from moisture. Tie down the full run of cable.



Dismantle the fuse holder to pass the cable through the firewall.

The vehicle battery must have a nominal rating of 12 V. Never connect the transceiver to a 24 V battery. Be sure to use a 12 V vehicle battery that has sufficient current capacity. If the current to the transceiver is insufficient, the Display may darken during transmission, or transmit output power may drop excessively.

Only after completing the installation, connect the transceiver's power supply connector to the DC power cable. Press the connectors firmly together until the locking tab clicks.

■ Replacing Fuses

If the fuse blows, determine the cause then correct the problem. After the problem is resolved, then replace the fuse. If newly installed fuses continue to blow, disconnect the power cable and contact your dealer or the nearest Service Center for assistance.

Fuse Location	Fuse Current Rating
TM-733	15 A
Supplied Accessory Cable	20 A

CAUTION: Only use fuses of the specified type and rating.

Note: If you use the transceiver for a long period when the vehicle battery is not fully charged, or when the engine is OFF, the battery may become discharged, and will not have sufficient reserves to start the vehicle. Avoid using the transceiver under these conditions.

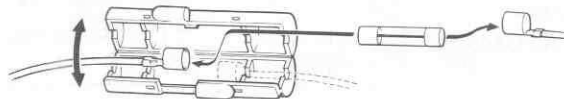

ANTENNA CONNECTION

Before operating mobile, you must first install an efficient, well-tuned antenna. The success of your mobile installation will depend largely on the type of antenna and its correct installation. The transceiver can give excellent results if the antenna system and its installation is given careful attention.

Your choice of antenna should have a 50 Ω impedance to match the transceiver input impedance. Use low-loss coaxial feed line that also has a characteristic impedance of 50 Ω . Coupling the antenna to the transceiver via feed lines having an impedance other than 50 Ω reduces the efficiency of the antenna system, and can cause interference to nearby broadcast television receivers, radio receivers, and other electronic equipment.

CAUTION: Transmitting without first connecting an antenna or other matched load may damage the transceiver. Always connect the antenna to the transceiver before transmitting.

TM-733A
(General)

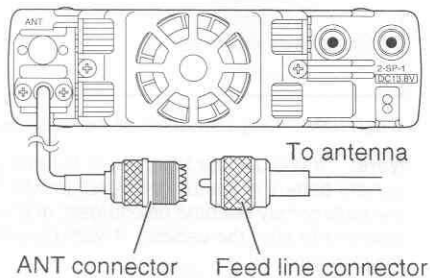

TM-733A
(U.S.A./ Canada)

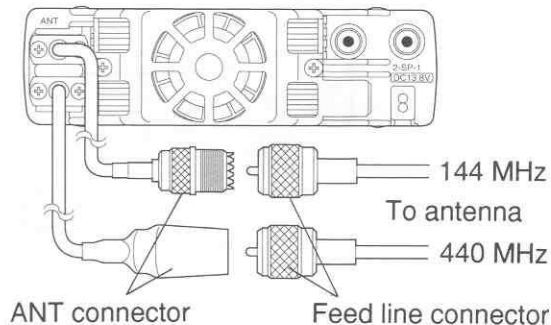

PREPARATION FOR FIXED STATION OPERATION

The following diagram illustrates how to make connections to the rear panel of the transceiver. Connect all cables securely so they will not come loose if pulled.

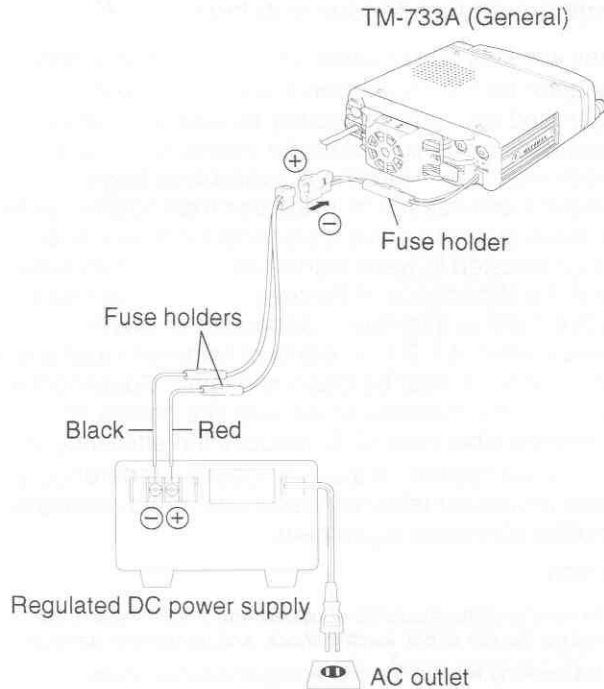

DC POWER SUPPLY CONNECTION

In order to use this transceiver for fixed station operation, you will need a separate 13.8 V DC power supply that must be purchased separately. **DO NOT** directly connect the transceiver to an AC outlet! Use the supplied DC power cable to connect the transceiver to a regulated power supply. Do not substitute a cable with smaller gauge wires. The recommended current capacity of your power supply is 12 A.

First connect the DC power cable to the regulated DC power supply and check that polarities are correct (Red: positive, Black: negative). Then connect the transceiver's DC power connector to the connector on the DC power cable. Press the connectors firmly together until the locking tab clicks.

Note:

- ◆ For your transceiver to fully exhibit its performance capabilities, the following optional power supply is recommended: PS-33 (20.5 A, 25% duty cycle).
- ◆ Before connecting the DC power supply to the transceiver, be sure to switch the transceiver and the DC power supply off.
- ◆ Do not plug the DC power supply into an AC outlet until you make all connections.

■ Replacing Fuses

If the fuse blows, determine the cause then correct the problem. After the problem is resolved, only then replace the fuse. If newly installed fuses continue to blow, disconnect the power plug and contact your dealer or the nearest Service Center for assistance.

Fuse Location	Fuse Current Rating
TM-733	15 A
Supplied Accessory Cable	20 A

CAUTION: Only use fuses of the specified type and rating.

ANTENNA CONNECTION

The type of the antenna system, consisting of the antenna, ground, and feed line, will greatly affect the successful performance of the transceiver. Use a properly adjusted 50 Ω antenna of good quality designed for operation at your operating frequency to let your transceiver perform at its best.

Install low-loss 50 Ω coaxial cable and a first quality connector for the connection to the transceiver. For longer feed line runs, especially for operation at UHF frequencies, you might consider investing in "hardline" transmission line. Hardline is available in larger diameters and has much lower loss than coaxial cable. The lower loss can make a significant difference for those interested in weak signal operation. In all cases, match the impedance of the feed line and antenna so that the SWR is minimum. Generally, an SWR measurement of 1.5:1 or less is considered satisfactory. All connections must be clean and tight. Coupling the antenna to the transceiver via feed line having an impedance other than 50 Ω reduces the efficiency of the antenna system. It also can cause interference to nearby broadcast television receivers, radio receivers, and other electronic equipment.

CAUTION:

- ◆ All fixed stations should be equipped with a lightning arrester to reduce the risk of fire, electric shock, and transceiver damage.
- ◆ Transmitting without first connecting an antenna or other matched load may damage the transceiver. Always connect the antenna to the transceiver before transmitting.

ACCESSORY CONNECTIONS

EXTERNAL SPEAKERS

If you plan to use external speakers, choose speakers with an impedance of 8 Ω . The external speaker jacks accept 3.5 mm diameter mono (2-conductor) plugs. Recommended speakers include the SP-50B and SP-41.

■ Receive Audio Switching

A variety of speaker configurations are possible by using either 1 or 2 external speakers. The Audio Switch function allows you to select the exact configuration that you like best.

Press **[F] (1 s)**, **[CONT SEL]** to toggle between Configuration 1 or Configuration 2 as described in the charts.

- Connecting 1 external speaker to speaker jack 2 will provide audio from both the VHF and UHF bands through your external speaker.

When using 1 external speaker connected to speaker jack 1:

Configuration 1		Configuration 2
VHF Band (Internal Speaker)	↔	VHF Band (External Speaker)
UHF Band (External Speaker)		UHF Band (Internal Speaker)

When using 2 external speakers:

Configuration 1		Configuration 2
VHF Band (External Speaker 1)	↔	VHF Band (External Speaker 2)
UHF Band (External Speaker 2)		UHF Band (External Speaker 1)

One External Speaker

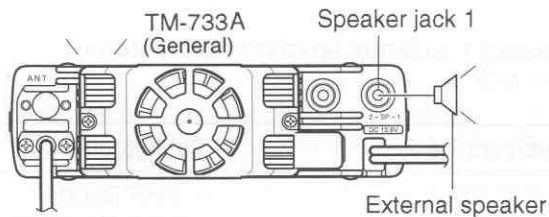

Two External Speakers

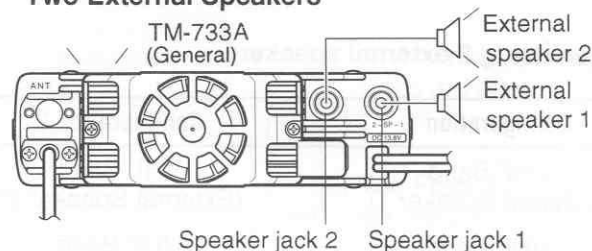

MICROPHONE

To communicate in the voice modes, plug a 600 Ω microphone equipped with an 8-pin modular connector into the modular socket on the Front Panel of the transceiver. Press firmly on the plug until the locking tab clicks..

PACKET EQUIPMENT

If you intend to use this transceiver for Packet operation, you will need the following equipment:

- Personal computer with communications software (Alternatively, a "dumb" terminal capable of sending ASCII commands)
- TNC (Terminal Node Controller)
- TNC power supply
- RS-232C cable
- 6-pin mini DIN plug (optional PG-5A)

Refer to the accompanying diagram and the associated instruction manuals to configure the equipment as shown. Connect your TNC to the DATA connector on the transceiver Front Panel using a cable equipped with a 6-pin mini DIN plug. Do not share a single power supply between the transceiver and the TNC. Keep as wide a separation between the transceiver and computer as practical to reduce noise-pickup by the transceiver.

■ DATA Connector Pinout

Pin Number	Pin Name	Function
1	PKD	Packet data input <ul style="list-style-type: none"> • Transmit data from TNC to transceiver
2	DE	Ground for PKD
3	PKS	Packet standby <ul style="list-style-type: none"> • TNC can use this pin to inhibit the transceiver microphone input while transmitting packet signals.
4	PR9	Detects 9600 bps data. (500 mV _{p-p} /10 kΩ)
5	PR1	Detects 1200 bps data. (300 mV _{p-p} /10 kΩ)
6	SQC	Squelch control output <ul style="list-style-type: none"> • Inhibits TNC data transmit while transceiver squelch is open. • Prevents interference to voice communications on the same frequency. Also prevents retries. • Output level Open squelch: +5 V (High) Closed squelch: 0 V (Low)

Note: See "REMOVING THE DATA CONNECTOR COVER" {page 111} to access the DATA connector on the Front Panel.

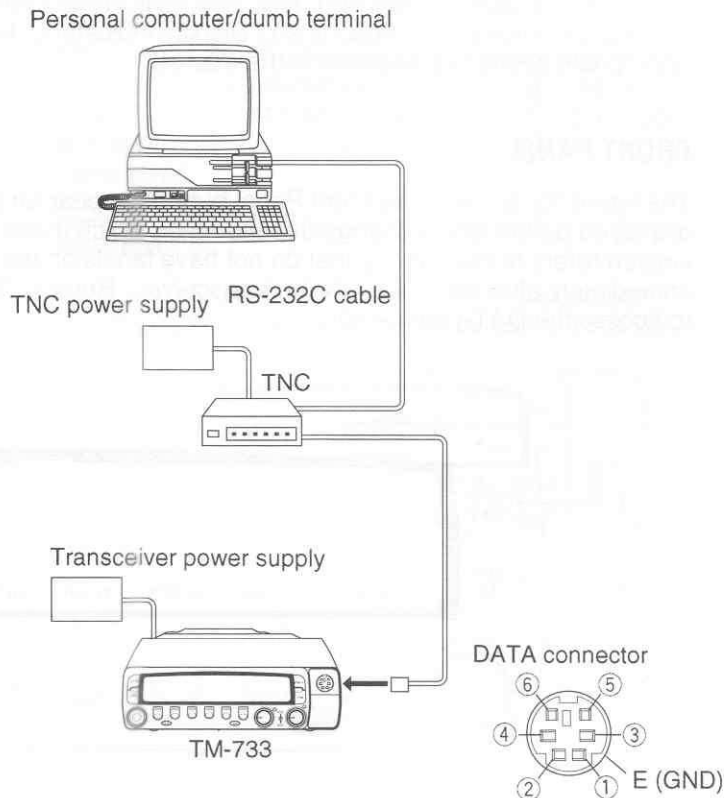

GETTING ACQUAINTED

The following sections describe basic functions of the Front Panel controls and buttons, Rear panel jacks and connectors, microphone buttons and Display indicators. For full explanations of functions mentioned, refer to the appropriate sections elsewhere in the manual.

FRONT PANEL

The labels for some of the Front Panel buttons appear on the Display instead of on the panel or buttons. The displayed button labels change depending on which mode the transceiver is in. This "GETTING ACQUAINTED" section refers to the buttons that do not have labels on the Front Panel by the labels that appear on the Display immediately after switching ON the transceiver. Refer to "REMOVING THE DATA CONNECTOR COVER" {page 111} to access the DATA connector.

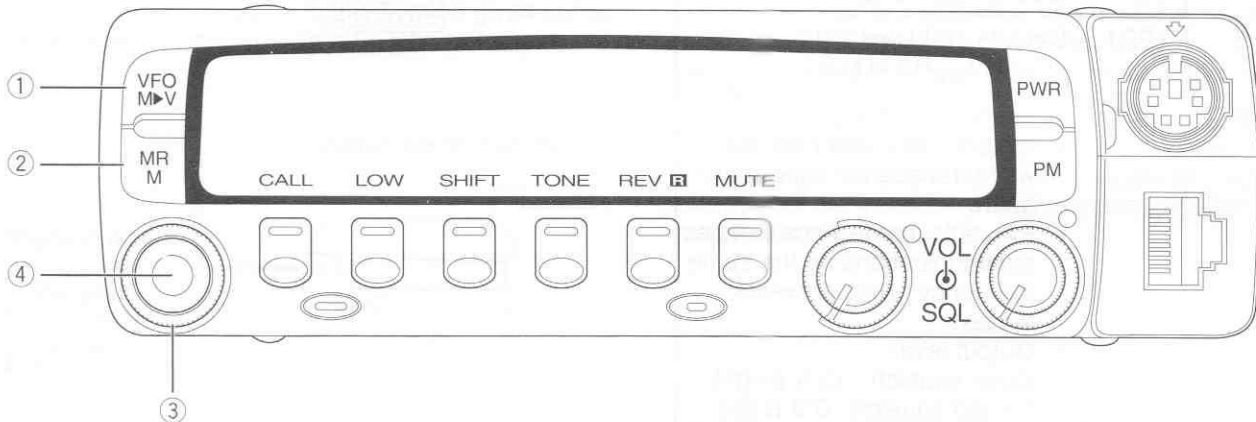

① **VFO** button

Selects the VFO mode {page 32}. The **Tuning** control changes the transceiver frequency in this mode. Also provides the following functions:

- Band Scan start/stop {page 69} to scan the entire VFO range
- Programmable Scan limits select mode {page 70} to program the limits for Programmable Scan
- Scan resume select (either Time-operated or Carrier-operated) {page 67} to choose under which condition Scan will continue scanning
- Memory channel or Call channel transfer to the VFO {page 44}
- Partial Reset {page 49}

② **MR** button

Selects the Memory Recall mode {page 44}. The **Tuning** control changes the memory channel in this mode. Also provides the following functions:

- Memory Scan start/stop {page 68}
- Memory channel write {page 42} to store data in memory channels
- Memory channel erase {page 45} to remove data from memory channels
- Memory channel lock-out {page 68} to prevent Memory Scan from stopping on a particular channel
- Full Reset {page 50}

③ **Tuning** control

Selects transmit/receive frequencies while in VFO mode and memory channels while in Memory Recall mode {page 44}. Also provides the following functions:

- Programmable Scan limits select {page 70} to choose the boundaries of this type of Scan
- Scan direction select {page 69} to choose if Scan progresses upward or downward in frequency
- Subaudible Tone frequency select {page 61} to choose the correct Tone for repeater access
- DTSS/Page code and Page memory select {pages 89, 93}
- Settings select for those functions that have several choices

The microphone **[UP]/[DWN]** buttons also provide the same functions as the **Tuning** control.

④ **MHz** button

Selects the MHz mode. This mode allows you to use the **Tuning** control or the microphone **[UP]/[DWN]** buttons to change the transceiver frequency in 1 MHz steps {page 36}. Also provides the following functions:

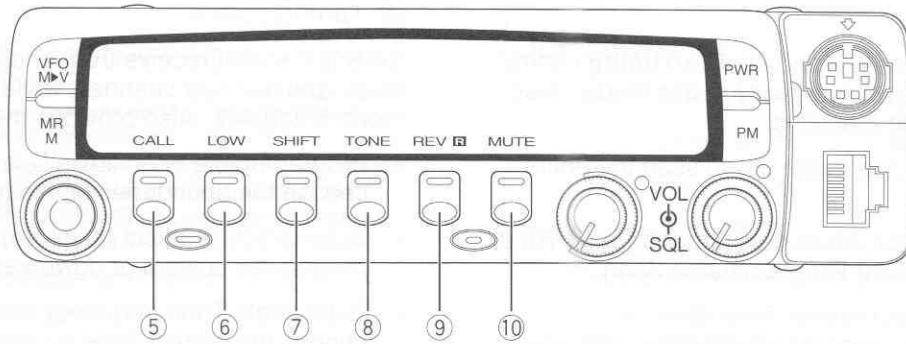

- 10 MHz select mode {page 36} to change the frequency in 10 MHz steps if your version of transceiver is capable of tuning wider than 10 MHz
- MHz Scan start/stop {page 71}
- Transceiver Lock {page 75} to lock most Front Panel buttons
- Automatic Power Off (APO) {page 76} to automatically switch OFF the transceiver power after a period of inactivity

⑤ **CALL** button

Toggles the transceiver between the Call channel mode and the current mode {page 45}. Also provides the following functions:

- Call Scan start/stop {page 71}

- Call channel write {page 46} to store the currently displayed frequency into the Call channel
- S-meter Squelch {page 28} or Noise Squelch {page 27} select to choose the best squelch method for the current receive conditions.
- Programmable VFO limits select mode {page 33}.

⑥ **LOW** button

Selects High, Mid, or Low transmit output power {page 39}. Also selects the following functions:

- Display illumination select mode {page 78} that allows you to use the **Tuning** control or the microphone **[UP]/[DWN]** buttons to select the best illumination for current lighting conditions, no display illumination, or no display

- Time-out Timer select mode {page 40} to limit continuous transmit time
- Squelch Hang Time select mode {page 28} to change the time the squelch remains open after loss of the received carrier

⑦ **SHIFT** button

Selects the transmit frequency offset with respect to the receive frequency {page 58}. The amount of offset depends on the band selected and version of transceiver that you have. Also provides the following functions:

- DTSS/Page function activate/deactivate {pages 91 and 94}
- DTSS/Page code select mode {pages 89 and 93}
- Auto Page Cancel {page 98} activate/deactivate

⑧ **TONE** button

Switches the Tone function ON or OFF {page 60}. When the TSU-8 option is installed, also switches the CTCSS function ON or OFF. Also provides the following functions:

- Tone Alert {page 99} activate/deactivate
- Tone/CTCSS frequency select mode {pages 61 and 87}
- Automatic Tone Frequency ID activate/deactivate {page 88}.

⑨ **REV** (Reverse) button

Switches the transmit frequency and receive frequency when operating with a transmit offset or a split memory channel {page 59}. Also provides the following functions:

- Frequency step mode select {page 35} to change the step size of the **Tuning** control while in VFO mode
- Beep select mode {page 77} to choose the level of the button acknowledgment beep, or to switch OFF the beep
- Automatic Simplex Checker activate/deactivate {page 60}.

⑩ **MUTE** button

Activates the Mute function {page 74} which automatically reduces the receive volume by approximately 20 dB on the other band when a signal is received on the Transmit band. Also provides the following functions:

- Automatic Band Change (A.B.C.) {page 73} activate/deactivate to have the transceiver automatically but temporarily select the band on which the squelch opens as the Transmit band.
- Advanced Intercept Point (AIP) {page 74}.

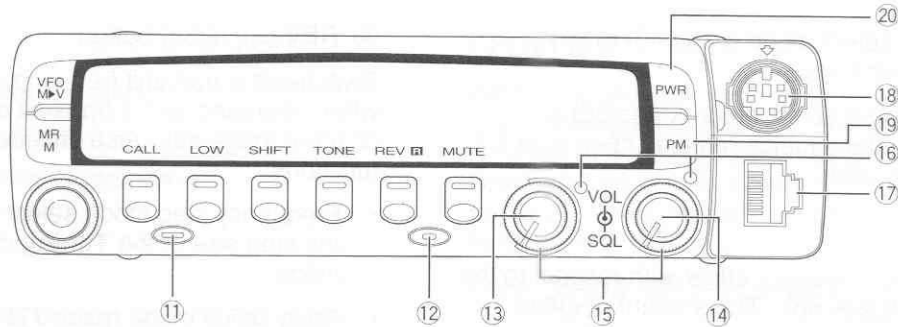

11 F (Function) button

Allows you to select the different functions that are available on multifunction buttons. Different functions are selected as follows:

- By pressing and releasing **[F]**, then pressing another button (**[F]**, **[Button]**)
- By pressing and holding **[F]** down for 1 second or more, releasing it, then pressing another button (**[F] (1 s)**, **[Button]**)
- By pressing and holding **[F]**, then pressing another button (**[F]+[Button]**)

12 CONT SEL (Control Select) button

Selects the band that you wish to control (Control band) with the Front Panel controls. The Control Select indicators (see Item 16) show which band is currently selected. Also provides the following functions:

- Remote Control mode select {page 80}
- VHF/VHF or UHF/UHF configuration {page 30}.

13 14 VOL (Volume) controls BAND SEL (Band Select) buttons

When turned, these controls adjust the level of receive audio from the speaker {page 26}. The left control adjusts the volume for the 144 MHz band, and the right control adjusts the volume for the 430/440 MHz band.

When pressed, these buttons select the desired Transmit band. The left button selects the 144 MHz band and the right button selects the 430/440 MHz band. These buttons are also used to select the band to be controlled from the Front Panel.

15 SQL (Squelch) controls

Adjust the squelch threshold level {page 27}. This allows you to mute speaker output while no stations are being received. The left control sets the threshold for the 144 MHz band and the right control sets the threshold for the 430/440 MHz band.

16 CONT SEL (Control Select) indicators

Light green to indicate which band is the Control band that can be controlled from the Front Panel (see Item 12).

17 Microphone connector

Insert the 8-pin modular connector plug until the locking tab "clicks".

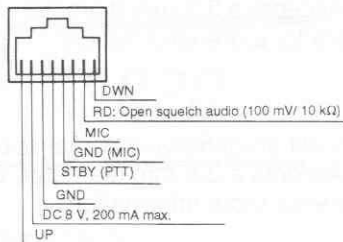

18 DATA connector

Connect a Terminal Node Controller (TNC) for Packet operation. Accepts a 6-pin mini DIN plug {page 11}. Refer to page 111 for instructions to remove the cover.

19 PM (Programmable Memory) button

Controls all aspects of the Programmable Memory function {page 51}.

20 PWR (Power) switch

Switches the transceiver ON or OFF {page 26}. Also provides the following functions:

- VFO Reset {page 49}
- Full Reset {page 50}

21 Release switch

Sliding this switch to the left releases the Front Panel from the Main Unit. Hold the Front Panel when using this switch to prevent the panel from falling when it is released. When re-installing the Front Panel, position the right rear edge of the panel first, then press the left front side of the panel firmly against the Main Unit. When the Release switch clicks, the Front Panel is secured.

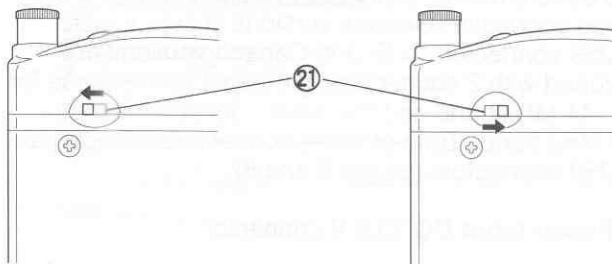

REAR PANEL

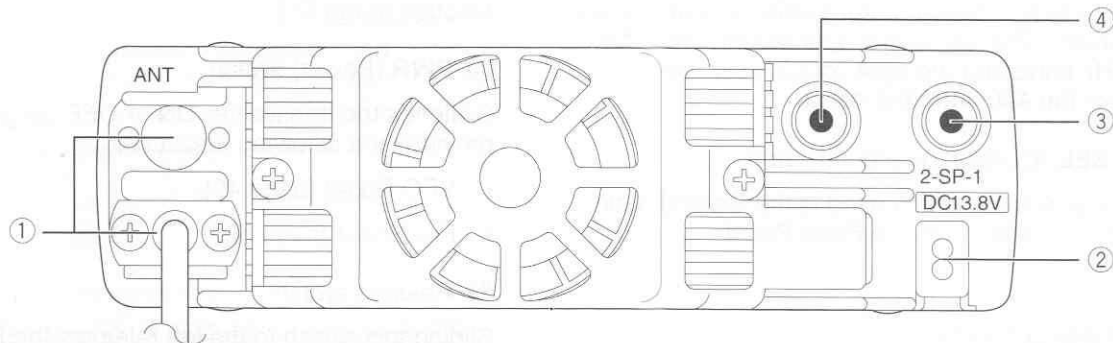

① ANT connector

Connect an external antenna(s). When making test transmissions, connect a dummy load in place of the antenna. The antenna system or load should have an impedance of 50 Ω . European and General versions are equipped with a single connector for connection of a dual band antenna. European versions accept a male N-type connector; General versions accept a male PL-259 connector. U.S. and Canada versions are equipped with 2 connectors; the upper connector is for the 144 MHz band and the lower connector is for the 440 MHz band. Both of these connectors accept male PL-259 connectors {pages 6 and 8}.

② Power Input DC 13.8 V connector

Connect a 13.8 V DC power source. Use the supplied DC power cable {pages 4 and 7}.

③ SP 1 jack

If you wish, connect an optional external speaker for clearer audio. Accepts a 3.5 mm diameter, 2-conductor plug. See page 9 for more information.

④ SP 2 jack

If you wish, connect an optional external speaker for clearer audio. Accepts a 3.5 mm diameter, 2-conductor plug. See page 9 for more information.

MICROPHONE

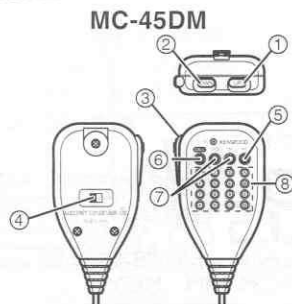

- ① **UP** button
- ② **DWN** button

Raises or lowers the VFO frequency, the memory channel number, the Tone/CTCSS frequency, the DTSS/Page code, or the Page memory number. Holding either button down causes the action to be repeated. Also, switches between values when selecting values for functions with multiple choices.

- ③ **PTT** (Push-to-talk) switch

Press to transmit; release to receive. Also used to exit various functions (e.g. Scan, DTSS/Page code select, Tone/CTCSS frequency select, etc.).

- ④ **LOCK** switch

Locks all microphone functions except **[PTT]** and the DTMF keypad, if equipped.

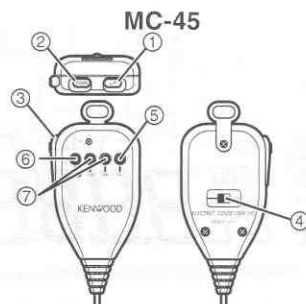

- ⑤ **PF** (Programmable Function) key

Switches the Transmit band between 144 MHz and 430/440 MHz. In other words, it duplicates the function of the Band Select buttons on the Front Panel. This key can be re-programmed, if desired {page 82}.

- ⑥ **CALL** key

Recalls the Call channel. Pressing for more than 1 second initiates a Call Scan. The Call function can be re-programmed, if desired {page 82}.

- ⑦ **VFO** key, **MR** key

Identical to the Front Panel functions of the same names. Both functions can be re-programmed, if desired {page 82}.

- ⑧ **DTMF keypad** (some versions only)

The 16-key keypad is used to transmit DTMF tones.

DISPLAY

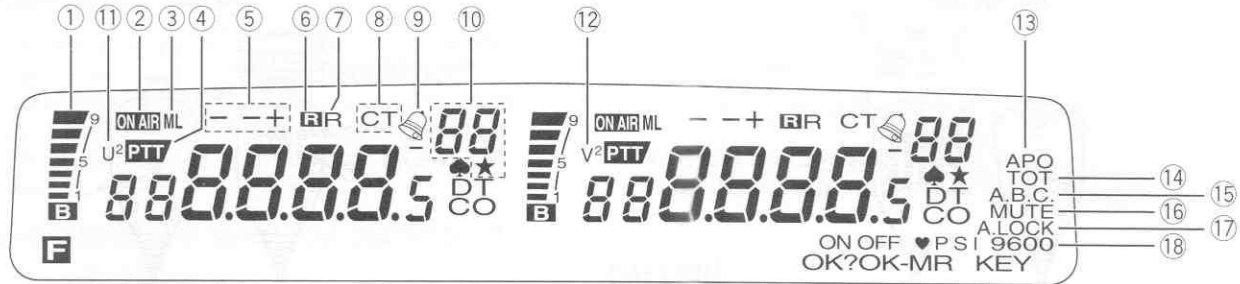

In Receive, acts as an S-meter to indicate the signal strength of received signals. The "B" indicates the squelch is open and the frequency is "busy". In Transmit, acts as an RF power meter to indicate the relative transmit output power {page 39}. Full scale represents High transmit power. Blinks when using External Remote Control.



Indicates the transceiver is in Transmit mode with a transmit frequency selected that is within a transmit band.



Indicate Low or Mid transmit output power is selected {page 39}. When "L" or "M" are not visible, High output power is selected.



Indicates the band that is currently the Transmit band.



Indicates the transmit frequency is offset (different) from the receive frequency {page 58}. The symbol displayed (either "+" or "-") indicates the direction that the transmit frequency is offset from the receive frequency. "- +" appears when a split-frequency memory channel is selected {page 43}.

European versions display "- -" when a wide offset is selected on the 430 MHz band.

⑥ **R**

Indicates the Automatic Simplex Checker (ASC) function {page 60} is ON.

⑦ **R**

Indicates the Reverse function is ON {page 59}. Transmit and receive frequencies are reversed.

⑧ **CT**

"T" indicates the subaudible Tone encoder function is ON {page 60}. "CT" indicates the CTCSS function is ON {page 87} provided the optional TSU-8 CTCSS unit is installed {page 110}.

⑨ 

Indicates the Tone Alert function is ON {page 99}. When using Tone Alert, this icon blinks after receipt of a signal that opens the squelch.

⑩ **88**

Displays the currently selected memory channel number {page 44}. The "star" icon indicates the selected memory channel is locked-out and will not be scanned by Memory Scan {page 68}.

⑪ **U²**

Indicates the dual UHF frequency function is ON {page 30}. In this mode, 2 UHF frequencies can be received simultaneously.

⑫ **V²**

Indicates the dual VHF frequency function is ON {page 30}. In this mode, 2 VHF frequencies can be received simultaneously.

⑬ **APO**

Indicates the Automatic Power Off function is ON {page 76}.

⑭ **TOT**

Indicates the Time-out Timer function is ON {page 40}.

⑮ **A.B.C.**

Indicates the Automatic Band Change function is ON {page 73}.

⑯ **MUTE**

Indicates the Automatic Mute function is ON {page 74}.

⑰ **A.LOCK**

Indicates the Transceiver Lock ("LOCK") or All Lock ("A.LOCK") function is ON {page 76}.

⑱ **9600**

Indicates the high speed data mode is selected which is suitable for Packet communication at 9600 bps {page 101}.

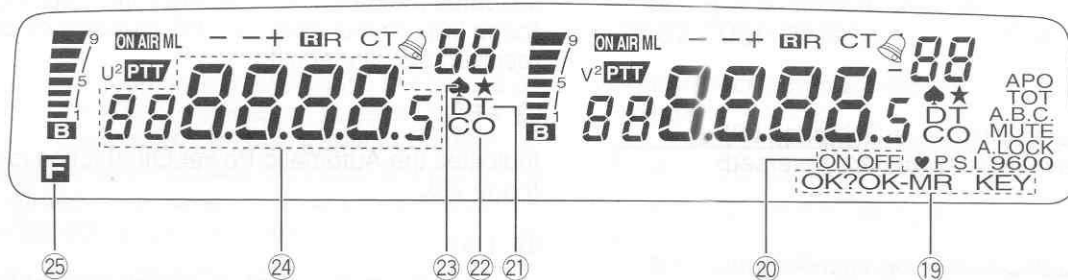

19 OK?OK-MR KEY

Blinks to confirm that you actually want to do a major reset. This includes Full Reset {page 50} or Programmable Memory Reset {page 56}.

20 ON OFF

Either ON or OFF appears for approximately 2 seconds after toggling the status of some functions.

21 DT

Indicates the Dual Tone Squelch System (DTSS) is ON {page 91}.

22 CO

Indicates Carrier-operated Scan Resume is ON {page 67}. When not visible, Time-operated Scan Resume is in effect.

23 ♠

Indicates AM receive mode is ON {page 34}. AM mode is available only on some versions of this transceiver.

24 88888s

Displays the transmit/receive frequency, frequency step {page 35}, Tone frequency {page 60} and other data.

The 1 MHz decimal point blinks while the transceiver is scanning (page 68). The 100 kHz decimal point appears when the Transmit band is locked {page 31}.

The 10 kHz decimal point appears when the AIP function is switched ON {page 74}.

25 **F**

Appears when the **[F]** button is pressed. Indicates alternate functions of multiple-function buttons can be accessed now. Blinks after the **[F]** button is held down for more than 1 second for access to additional functions using the multiple-function buttons.

BUTTON FUNCTION DISPLAY



Some of the Front Panel buttons have several functions. This allows us to provide many functions on your transceiver but keep the transceiver case small. To simplify operation, the lower portion of the Display has labels that indicate the current function of each of the 6 buttons on the lower edge of the Front Panel. The label appears immediately above its corresponding button.

When using any of the alternate functions of the multiple function buttons, you have 10 seconds to select an alternate function after pressing the [F] button. Pressing [F] again or waiting for 10 seconds restores the Basic state with button definitions of [CALL], [LOW], [SHIFT], [TONE], [REV], and [MUTE].

■ Basic State Display Labels

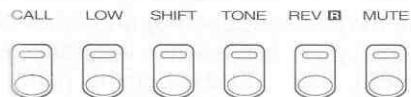

■ Labels After Pressing [F]

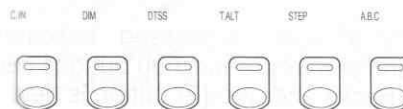

■ Labels After Pressing [F] for More than 1 Second



■ Programmable Memory Recall Labels

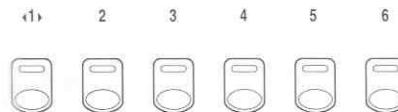

CONFIRMATION BEFORE OPERATION

Before proceeding, run through the following checklist to double check that your transceiver is ready to operate:

FRONT PANEL

Controls

- Are the **VOL** and **SQL** controls turned fully counterclockwise?

Microphone

- Is a recommended microphone installed?

DATA Connector

- Is a TNC connected correctly if you plan to operate Packet?

REAR PANEL

ANT (Antenna)

- Is the correct antenna actually connected?
- Is a lightning protector installed for a fixed station?
- Are interconnecting coaxial cables between the transceiver, accessory station equipment and the antenna connected?
- Are all cable connectors well-installed (including no cold solder joints?) and screwed tight?
- Are coax switches set for the correct antenna?

CAUTION: *DO NOT transmit without connecting an antenna or dummy load to the ANT connector. The transceiver can fail.*

DC 13.8 V (DC Power Cable)

- Is the power cable connected and locked in place? (Do not turn on the transceiver or DC power supply yet.)

RECEIVING

SWITCHING POWER ON/OFF

Switch ON the DC power supply, then press **[PWR]** to switch ON the transceiver.

- If operating mobile, simply press **[PWR]** on the transceiver.
- After the "- on -" message, the frequency and other indicators appear on the Display.

To switch OFF the transceiver, press and hold **[PWR]** briefly.

- In a fixed installation, after the transceiver has been switched ON, it can then be switched OFF or ON by using only the power switch on the DC power supply.

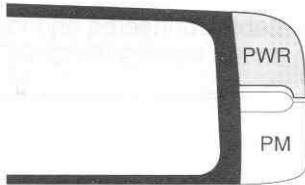

VOLUME ADJUST

The transceiver has separate volume controls for each band. The left **VOL** control adjusts the audio level for the band displayed on the left; the right **VOL** control adjusts the audio level for the band displayed on the right. Turn the controls clockwise to increase the audio level, and counterclockwise to decrease the level.

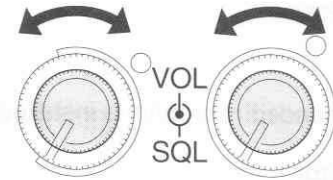

Left Display

Right Display

SQUELCH ADJUST

The purpose of squelch is to silence audio output from the speaker when no signals are present. When squelch is set correctly, you will hear sound only while a station is actually being received. At this time, "B" appears on the Display for the band on which a station is being received. Decide which squelch type you wish to use, then follow that procedure.

■ Noise Squelch

Similar to the **VOL** controls, the transceiver has separate squelch controls for each band. The left **SQL** control adjusts the squelch threshold for the band displayed on the left; the right **SQL** control adjusts the squelch threshold for the band displayed on the right.

Since the transceiver receives on both bands simultaneously, adjust each **SQL** control while the **VOL** control for the other band is fully counterclockwise. For example, turn the right **VOL** control fully counterclockwise, then adjust the left **SQL** control as explained below and vice versa.

With the left **VOL** control turned clockwise enough to hear background noise from the speaker, turn the left **SQL** control clockwise to just eliminate the background noise when no signals are present. The point at which ambient noise on a frequency just disappears, called the squelch threshold, depends on the frequency.

Setting the squelch threshold too high causes squelch to remain closed while a weak signal is present. The station will not be heard. You may mistakenly think your transceiver's receive sensitivity is low or you have an audio problem. Setting the threshold too low allows noise to be heard between transmissions from other stations.

Repeat this procedure using the right **VOL** and **SQL** controls.

■ Automatic Squelch

Squelch operation may be controlled automatically by the transceiver microprocessor. This function selects the squelch threshold for both bands without touching either **SQL** control. Since the **SQL** controls have no effect after Automatic Squelch is switched ON, you won't have to worry about accidentally changing the squelch threshold.

- 1 Press **[MHz]+ POWER ON** to toggle Automatic Squelch ON or OFF for both bands.
 - "ON" appears briefly on the lower right corner of the Display when the function is switched ON. The default is OFF.
- 2 Press **[F]+[DIM]** to set the threshold on the current Control band {page 29}.
- 3 Press **[CONT SEL]** and repeat step 2 to set the threshold on the other band.

Note: Automatic Squelch cannot be switched ON if S-meter Squelch is activated.

■ S-Meter Squelch

By activating S-meter Squelch, you can set the squelch threshold so the squelch does not open until a signal with the same or greater strength than the S-meter setting is received. This function is useful to eliminate constantly resetting the squelch when receiving weak stations that you have no interest in contacting. Independent S-meter values can be set on each band.

- 1 Press **[BAND SEL]** to select your desired band.
 - The corresponding Control Select indicator lights.
- 2 Press **[F] (1 s), [S.SQL]**.
 - "ON" appears briefly on the lower right corner of the Display when the function is switched ON. Also, an indicator appears beside the S-meter for the band selected that shows the minimum signal that will open the squelch. The default is OFF.
- 3 Adjust the **SQL** control threshold for the band on which you are activating S-meter Squelch. Set the S-meter for the minimum signal strength that you want to open the squelch.
- 4 Repeat Step 2 to deactivate S-meter Squelch and return to Noise Squelch.
 - "OFF" appears briefly on the lower right corner of the Display.

Note: S-meter Squelch can be switched ON even if Automatic Squelch is activated.

■ Squelch Hang Time

When using S-meter Squelch you may want to adjust the time interval between when the received carrier drops and when the squelch closes. For example, when receiving a weak signal, select a high value such as 500 ms to prevent the squelch from closing prematurely. When signals are strong, use a lower value such as 125 ms or OFF to allow quick turnarounds in the conversation.

- 1 Press **[F]+[DIM]**.
 - The current Squelch Hang Time appears.

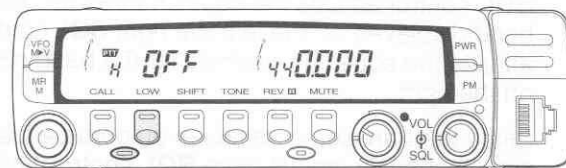

- 2 Use the **Tuning** control, or microphone **[UP]/[DWN]**, to select a value.
 - The available selections are "OFF", "125", "250", and "500" ms. The default is "OFF".

3 Press **[MHz]** or microphone **[PTT]** to return to the previous mode.

- Any Front Panel button, microphone button, or switch can be used in this step except microphone **[UP]/[DWN]** and the microphone DTMF keypad keys. It's not advisable to use **[BAND SEL]**, **[CONT SEL]**, or **[PWR]** because they will also perform their own functions.

■ RD Output Squelch Control

When this function is switched ON, receive audio is available at the RD terminal in the microphone connector only when the squelch is open. This function is necessary if you want to connect a TNC for Packet operation to the microphone connector instead of using the DATA connector. However, the DATA connector is recommended for this application {page 10}.

Press **[TONE]+ POWER ON** to toggle the RD output squelch control ON or OFF.

- "ON" appears briefly on the lower right corner of the Display when the function is switched ON. The default is ON.

BAND SELECT

This transceiver can be used in one of the following configurations at a time. Configuration 1 is the default.

Configuration	Receive	Transmit
1	VHF and UHF	VHF or UHF
2	VHF and VHF	VHF
3	UHF and UHF	UHF

In Configuration 1, you can switch the Transmit band between VHF and UHF by using the **[BAND SEL]** buttons. Press the left **[BAND SEL]** button to select the 144 MHz band as the Transmit band and the right **[BAND SEL]** button to select the UHF band as the Transmit band. You always know which is the Transmit band by checking the "PTT" indicator on the Display. The "PTT" indicator appears above the frequency that is the current transmit frequency.

Press the **[CONT SEL]** button to toggle the Control band between the 144 MHz band and the 430/440 MHz band. The left Control Select indicator lights while the 144 MHz band is the Control band and the right Control Select indicator lights while the 430/440 MHz band is the Control band.

■ VHF/VHF Operation

To use Configuration 2, you must first select the VHF/VHF mode. In this mode, both Displays show a 144 MHz frequency. You can receive two different frequencies on the 144 MHz band simultaneously and transmit on one of these frequencies.

- 1 Press the right **[BAND SEL]** to select the 430/440 MHz band.
 - The right Control Select indicator lights.
- 2 Press **[VFO]**, **[MR]**, or **[CALL]**.
- 3 Press **[F]**, **[CONT SEL]**.
 - If "V²" appears on the right Display, the transceiver is in Configuration 2.
 - If "V²" does not appear on the right Display, repeat this step.
 - The VFO frequency, memory channel or Call channel data on the V² Display is from the VHF band.
- 4 Repeat Step 3 to switch back to Configuration 1 with one VHF band and one UHF band.

■ UHF/UHF Operation

To use Configuration 3, you must first select the UHF/UHF mode. In this mode, both Displays show a 430/440 MHz frequency. You can receive two different frequencies on the 430/440 MHz band simultaneously and transmit on one of these frequencies.

- 1 Press the left **[BAND SEL]** to select the 144 MHz band.
 - The left Control Select indicator lights.
- 2 Press **[VFO]**, **[MR]**, or **[CALL]**.
- 3 Press **[F]**, **[CONT SEL]**.
 - If "U²" appears on the left Display, the transceiver is in Configuration 3.
 - If "U²" does not appear on the left Display, repeat this step.
 - The VFO frequency, memory channel or Call channel data on the U² Display is from the UHF band.
- 4 Repeat Step 3 to switch back to Configuration 1 with one VHF band and one UHF band.

Note:

- ◆ Both V^2 and U^2 functions cannot be used simultaneously. Only V^2 or U^2 can be used at one time. For example, if you attempt to activate U^2 while you are using V^2 , U^2 will be switched OFF automatically when Step 3 is done in the above procedures.
- ◆ Receiver performance, for example image rejection and sensitivity, may be less when using either V^2 or U^2 mode. If the same frequency is selected on both bands when using these modes, the S-meter reading may be affected. Also, receive volume may be lower depending on the position of the **VOL** controls.

■ **Transmit Band Lock**

This function locks the Transmit band to either the 144 MHz band or the 430/440 MHz band. When Transmit Band Lock is activated, the **[BAND SEL]** buttons and the microphone **[PF]** button only change the Control band; they do not affect the Transmit band.

1 Press [F], [BAND SEL].

- The 100 kHz decimal point appears on the Display of the locked band.
- Refer to the chart.

2 To unlock this function, repeat Step 1.

Before		Press	After	
VHF Band	UHF Band		VHF Band	UHF Band
U	U	[F], VHF [BAND SEL]	L	U
U	L		L	U
L	U		U	U
U	U	[F], UHF [BAND SEL]	U	L
U	L		U	U
L	U		U	L

L: Locked
U: Unlocked

■ Blanking a Band Display

If you have no plans to use one of the bands, you may want to remove the frequency display for the unused band. This reduces the amount of information on the Display which makes it simpler to read the information you need. Transmit and receive are not possible on the band on which you blank the frequency display. However, this action has no effect on the remaining band.

Press **[F] (1 s)**, **[BAND SEL]** to toggle either the 144 MHz or 430/440 MHz Band Display ON or OFF.

- Press the left **[BAND SEL]** to blank the 144 MHz band and the right **[BAND SEL]** to blank the 430/440 MHz band.
- "-OFF-" appears for about 10 seconds before the Display is blanked. When **[BAND SEL]** for a blanked band or when the power is switched ON, the blanked Display also shows "-OFF-" for the same amount of time before blanking.



Note: If both Band Displays are switched OFF but the transceiver power is not switched OFF, audio for the band switched OFF last will be present at the RD terminal in the microphone connector when the bands are switched ON again. If necessary, press the **[BAND SEL]** button of the band being used to restore the RD output.

VFO MODE

The VFO mode allows you to select operating frequencies by using the **Tuning** control or the microphone as explained under "SELECTING FREQUENCIES" in the next section.

- 1 Press **[BAND SEL]** to select your desired band.
- 2 Press **[VFO]** to select VFO mode.
 - The currently selected frequency appears.
 - If already in VFO mode, there is no change.

VFO mode must be selected when using the following functions:

Select VFO mode to use the following functions	Page Ref.
Programmable Band Scan Limit select	70
Programmable VFO Limit select	33

SELECTING FREQUENCIES

■ Tuning Control

Using the **Tuning** control is convenient when you are within easy reach of the transceiver Front Panel, and the frequencies to be selected lie near the current frequency.

- 1 Press **[BAND SEL]** to select your desired band.
- 2 Press **[VFO]** to select VFO mode.
- 3 Turn the **Tuning** control to select a receive frequency.
 - Clockwise rotation increases the frequency one frequency step at a time.
 - Counterclockwise rotation decreases the frequency one frequency step at a time.

If you cannot select a particular receive frequency, the frequency step size needs to be changed. See "FREQUENCY STEP SIZE" {page 35} for further information.

Note: Frequencies can also be selected via the microphone keypad. See "KEYPAD DIRECT ENTRY" {page 83}.

■ Microphone [UP]/[DWN] Buttons

Using microphone **[UP]/[DWN]** for frequency selection is useful when mobilizing or anytime you are not immediately in front of the transceiver.

Press **[UP]** or **[DWN]** once to change the receive frequency by one frequency step in the direction indicated by the button.

- Pressing and holding either button causes the frequency to step repeatedly in one direction until the button is released.

■ Programmable VFO

You may want to set limits for the minimum and maximum frequencies that are selectable with the **Tuning** control/microphone. The limits can be set or modified at any time, and are configurable for both bands on the transceiver.

- 1 Press **[BAND SEL]** to select your desired band.
- 2 Press **[VFO]** to select VFO mode.

- Press **[F]+[C.IN]**.
 - "L" appears. The default is the currently selected frequency.
- Turn the **Tuning** control, or press microphone **[UP]/[DWN]**, to display the desired lower limit.

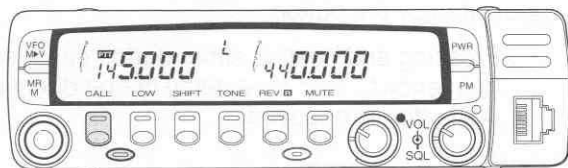

- Press **[MR]** to store the lower limit.
 - "U" appears. The default is the currently selected frequency.
- Turn the **Tuning** control, or press microphone **[UP]/[DWN]**, to display the desired upper limit.



- Press **[MR]** to store the upper limit.
 - The previous mode is restored.

Note: The lower limit must be lower in frequency than the upper limit. The minimum programmable range is 1 MHz, and selections must be made within 10 seconds or the previous mode is restored.

AM/FM MODE (SOME VERSIONS ONLY)

Some versions of the transceiver are able to receive AM and FM modes. The AM mode is selected automatically when any frequency in the range 118.000 to 135.995 MHz (AIR band) is chosen. Outside this range, the default is FM. However, either mode can be selected manually on any VHF frequency. Crossing the 136.000 MHz boundary restores the default modes.

- Press the VHF **[BAND SEL]**.
 - The VHF **[BAND SEL]** is the left Band Selector button.
- Press **[MHz] (1 s)** to toggle between the AM or FM mode.



- The available selections are AM or FM. The default is AM for 118.000 MHz to 135.995 MHz, and FM on all other frequencies.
- The "spade" indicator remains ON if the AM mode was selected.
- When AM is selected outside the AIR band, the "spade" disappears while transmitting since FM is used for transmissions.

FREQUENCY STEP SIZE

Choosing the correct step size is essential in order to select your exact receive frequency with the **Tuning** control or microphone **[UP]/[DOWN]**. The best step size on each band is the largest step that will still allow you to select all frequencies on which you plan to operate. Using the best step size reduces the time required to select new frequencies; operating becomes easier.

Version	Defaults (kHz)	
	VHF	UHF
Canada, U.S.A.	5	25
Europe General	12.5	25

- 1 Press **[BAND SEL]** to select your desired band.
- 2 Press **[VFO]** to select VFO mode.
- 3 Press **[F]**, **[STEP]**.
 - The current step size for the band selected appears.

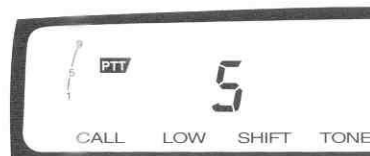

- 4 Turn the **Tuning** control, or press microphone **[UP]/[DWN]**, to select the desired 1 or 10 MHz digit.
- When using the 10 MHz function, the 10 MHz digit only changes if your receiver coverage is wider than 10 MHz on the selected band.
- 5 If using the 1 MHz function, press **[MHz]** to restore the previous frequency step and return to the VFO mode. If using the 10 MHz function, press **[MHz], [MHz]**.
- If you press only **[MHz]** after using the 10 MHz function, you can then use the 1 MHz function if you wish before restoring the previous frequency step and VFO mode.

5, 10, 15 or 20 kHz Step Size	→	12.5 or 25 kHz Step Size
Displayed Frequency (10 kHz/ 1 kHz)		Displayed Frequency (10 kHz/ 1 kHz)
00, 05, 10, 15		00
20, 25, 30, 35		25
40, 45, 50, 55		50
60, 65, 70, 75, 80, 85, 90, 95		75

■ Changes in Displayed Frequencies

Changing between step sizes may result in a change of the displayed frequency. When a change occurs, and by how much, is shown in the accompanying charts.

For example, assume 144.995 MHz is displayed with a 5 kHz step size selected. Changing to a 25 kHz step size alters the displayed frequency to 144.975 MHz.

12.5 or 25 kHz Step Size	→	5, 10, 15 or 20 kHz Step Size
Displayed Frequency (10 kHz/ 1 kHz/ 500 Hz)		Displayed Frequency (10 kHz/ 1 kHz)
00		00
12.5		10
25		20
37.5		30
50		50
62.5		60
75		70
87.5		80

TRANSMITTING

MICROPHONE PTT

When ready to begin transmitting, press and hold **[PTT]** and speak in a normal tone of voice. Speaking too close to the microphone, or too loudly, may increase distortion and reduce intelligibility of your signal at the receiving station.

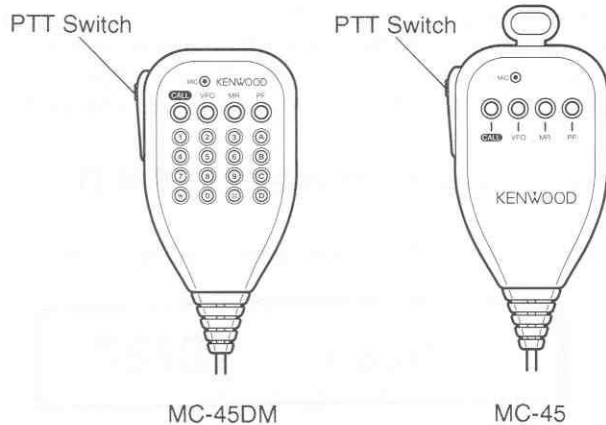

Note: When transmitting, you may want to use the Mute function to mute the receive audio from the band on which you are not transmitting. Refer to MUTE on page 74 for details.

SELECTING OUTPUT POWER

It's wise, and required by law, to select the lowest power that allows reliable communication. If operating from battery power, lower transmit power will give you more operating time before a charge is necessary. Reducing power lowers the risk of interfering with others on the band too. It is possible to change output power while transmitting.

- 1 Press **[BAND SEL]** to select your desired band.
- 2 Press **[LOW]** to select the transmit power you require.
 - Each press of **[LOW]** changes the power as shown below. The default is High (no indicator visible).

This procedure selects the transmit power on the Transmit band. Press **[CONT SEL]** in Step 1 if you want to select a different power on the Control band.

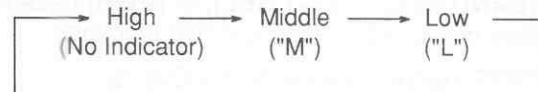

Band	High	Mid	Low
VHF	50 W	10 W	Approx. 5 W
UHF	35 W	10 W	Approx. 5 W

TIME-OUT TIMER (TOT)

It is sometimes necessary or desirable to restrict a single transmission to a specific maximum time. This feature can be useful when accessing repeaters to prevent repeater time-outs, or when particularly trying to conserve battery power. Activate TOT anytime you wish to limit your transmit time.

- 1 Press **[F] (1 s), [TOT]**.
 - The current TOT selection appears.
- 2 Turn the **Tuning** control, or press microphone **[UP]/[DWN]**, to select the desired timer value.
 - The available selections are "OFF", "3", "5", "10", "20", and "30" minutes. The default is "OFF".
- 3 Press **[MHz]** or microphone **[PTT]** to return to the previous mode.
 - Any Front Panel button, microphone button, or switch can be used in this step except microphone **[UP]/[DWN]** and the microphone DTMF keypad keys. It's not advisable to use **[BAND SEL]**, **[CONT SEL]**, or **[PWR]** because they will also perform their own functions.
 - "TOT" remains visible on the Display.

When TOT times out, the transceiver automatically returns to Receive. To resume transmitting, release and then press **[PTT]** again.

MEMORY CHANNELS

VHF/UHF MEMORY CHANNEL RATIO

The transceiver has a total of 70 memory channels for storing frequencies and related data. This total number of 70 channels can be divided between the two bands in different ratios. The default is 30 channels on the 144 MHz band and 40 channels on the 430/440 MHz band. The chart lists the different memory configurations available.

Configuration	VHF Band	UHF Band
1	5	65
2	10	60
3	15	55
4	20	50
5	25	45
6	30	40
7	35	35
8	40	30
9	45	25
10	50	20
11	55	15
12	60	10
13	65	5

Note: The VHF/UHF memory channel configuration must be done before storing any data in memory channels. Changing configurations erases all memory channels except memory channel 1.

- 1 Press **[F]+[MR]+ POWER ON** to select the memory channel configuration mode.
 - The current configuration appears. The left number is the quantity of VHF memory channels. The right number is the quantity of UHF memory channels.



- 2 Turn the **Tuning** control, or press microphone **[UP]/[DOWN]**, until the configuration you prefer appears on the Display.
- 3 Press **[MR]** to store your choice.
 - Pressing any other button cancels the configuration mode. The previous memory channel configuration remains valid.

STORING DATA IN MEMORY

Each memory channel can be used either as a simplex channel or split channel for storing any frequency or frequency pair that can be selected on the transceiver. Alternatively, a standard offset and offset direction required for using repeaters can be stored. Refer to "OPERATING THROUGH REPEATERS" {page 57}.

The data listed below can be stored in each memory channel:

Parameter	Simplex Channel	Split Channel
RX frequency	YES	YES
TX frequency		YES
Tone (CTCSS) frequency	YES	YES
Tone or CTCSS status	YES	YES
Frequency step	YES	YES
Shift status, REV status	YES	N/A
DTSS code, DTSS status	YES	YES

YES: Can be stored in memory.

N/A: Not applicable

Note: On European versions, when the 1750 Hz Tone frequency is selected, the Tone/CTCSS status cannot be stored.

There are 2 methods of storing transmit/receive frequencies and associated data in memory channels depending on the relationship of the transmit and receive frequencies:

- Simplex memory channels:
RX frequency = TX frequency
- Split memory channels:
RX frequency \neq TX frequency

■ Simplex Memory Channels

- 1 Select the desired band, frequency, and associated data (Tone, CTCSS, DTSS, etc.) using VFO mode, Memory Recall {page 44} or the Call channel {page 45}.
- 2 Press **[F]** to select Memory Storage.
 - "F" and a memory channel number appear.



- 3 Turn the **Tuning** control, or press microphone **[UP]/[DWN]**, to select the desired memory channel.

4 Press **[MR]**.

- The selected frequency and associated data are stored in the memory channel. A transmit frequency from a split memory channel or split Call channel is not stored.
- If the memory channel selected in the previous step already contained data, the new data overwrites the previous data.
- The previous mode is restored.

Note: Pressing **[F]**, **[MR]** will update a memory channel with newly selected data.

■ Split Memory Channels

- 1 Select the desired band, receive frequency, and associated data (Tone, CTCSS, DTSS, etc.) using VFO mode, Memory Recall {page 44} or the Call channel {page 45}.
- 2 Press **[F]** to select Memory Storage.
 - "F" and a memory channel number appear.
- 3 Turn the **Tuning** control, or press microphone **[UP]/[DWN]**, to select the desired memory channel.

4 Press **[MR]** (1 s).

- "- +" appears.



5 Turn the **Tuning** control, or press microphone **[UP]/[DWN]**, to select the desired transmit frequency.

6 Press **[MR]**.

- The selected transmit frequency is stored in the memory channel, and the previous mode is restored.
- Associated data selected in Step 1 such as Tone status/frequency, the frequency step, and DTSS status/code are not altered by this step. However, Transmit Offset status and Reverse status are erased.
- Storing a receive frequency in a split memory channel erases any previous data in that channel.

RECALLING MEMORY CHANNELS

This section explains how to select in numerical order by channel number all memory channels containing data.

- 1 Press **[BAND SEL]** to select your desired band.
- 2 Press **[MR]**.
 - The memory channel used last is recalled.
- 3 Turn the **Tuning** control, or press microphone **[UP]/[DWN]**, to select the desired memory channel.
 - Clockwise or microphone **[UP]**: Increases the channel number.
 - Counterclockwise or microphone **[DWN]**: Decreases the channel number.
 - Empty memory channels cannot be recalled.
 - If **[VFO]** is pressed, the VFO mode is restored.

Note:

- ◆ *Memory channels can also be recalled via the microphone keypad. See "Memory Channel or Tone/CTCSS Number Entry" (page 85).*
- ◆ *When a split memory channel is recalled, "-+" appears on the Display. Press **[REV]** to display the transmit frequency.*

MEMORY → VFO TRANSFERS

Transferring the contents of a memory channel or the Call channel to the VFO can be useful if you wish to search for other stations or a clear frequency near the selected memory channel or Call channel frequency.

- 1 Press **[BAND SEL]** to select your desired band.
- 2 Press **[MR]** to select Memory Recall. If you wish to select the Call channel, press **[CALL]**.
- 3 Recall the desired memory channel by turning the **Tuning** control or pressing microphone **[UP]/[DWN]**.
 - This step is not necessary if the Call channel was selected in Step 2.
- 4 Press **[F], [VFO]**.
 - The complete contents of the memory channel or the Call channel are copied to the VFO. VFO mode is selected after the transfer is completed.
 - A transmit frequency from a split memory channel or split Call channel is not transferred to the VFO.
 - A memory channel that contains a frequency outside the range of a VFO that has programmed limits {page 33} will transfer to the VFO. However, as soon as the frequency is changed, the VFO frequency will jump within the programmed range.
 - When using the UHF/UHF configuration {page 30} transferring a memory channel with a 5 kHz step to the U² band causes the frequency step to change to 10 kHz.

ERASING MEMORY CHANNELS

Although it is possible to overwrite existing data in any of the memory channels with new data, at times you may wish to clear data from memory channels without entering new data. It's convenient to clear channels no longer used so you can identify channels that are free for memorizing new frequencies. Memory channels that contain no data cannot be recalled while in Memory Recall.

- 1 Press **[BAND SEL]** to select your desired band.
- 2 Press **[MR]** to select Memory Recall.
- 3 Select the desired memory channel by turning the **Tuning** control or pressing microphone **[UP]/[DWN]**.
- 4 Press **[F]+[MR]**.
 - The contents of the memory channel are erased.

Note: Memory channel 1 cannot be erased.

CALL CHANNEL

The Call channel can be used to store any frequency that can be selected on your transceiver that you wish to make your main operating frequency. The Call channel can be programmed with a simplex frequency or a split frequency. No matter what mode the transceiver is in, the Call channel always can be selected quickly. You may wish to dedicate the Call channel on a group-wide basis as an emergency channel only to be used for urgent communications. In this case, one of the Call channel scans {page 71} will be useful.

■ Recalling the Call Channel

- 1 Press **[BAND SEL]** to select your desired band.
- 2 Press **[CALL]** to retrieve the contents of the Call channel on the selected band.
 - "C" appears on the Display.



- If **[CALL]** is pressed again, "C" clears and the previous mode is restored.
- The **Tuning** control and microphone **[UP]/[DWN]** do not function while the Call channel is selected.

- It is possible that a memory channel may be recalled and data such as Transmit Offset, Tone, etc. are changed but not stored. If after the Call channel is used you select the previous memory channel, you will find the temporarily changed data is gone, and only the data actually stored in the memory channel will be recalled.

The Call channel defaults are as follows:

Version	Defaults (MHz)	
	VHF	UHF
Canada U.S.A.	144.000	440.000
Europe General	144.000	430.000

The contents of the Call channel cannot be deleted; however, you can overwrite old data with new data as described in the next section.

■ Changing Call Channel Contents (Simplex)

- 1 Select the desired band, frequency and associated data (Tone, CTCSS, DTSS, etc.) using VFO mode or Memory Recall.
- 2 Press **[F]**, **[C.IN]**.
 - The selected frequency and associated data are stored in the Call channel. A transmit frequency from a split memory channel is not stored.
 - The previous mode is restored.

■ Changing Call Channel Contents (Split)

- 1 Select the desired band, receive frequency, and associated data (Tone, CTCSS, DTSS, etc.) using VFO mode or Memory Recall.
- 2 Press **[F]**, **[C.IN]** (1 s).
 - " - + " appears.



- 3 Turn the **Tuning** control, or press microphone **[UP]/[DWN]**, to select the desired transmit frequency.
- 4 Press **[CALL]**.
 - The selected transmit frequency is stored in the Call channel, and the previous mode is restored.
 - Associated data selected in Step 1 such as Tone status/frequency, the frequency step, and DTSS status/code are not altered by this step. However, Transmit Offset status and Reverse status are erased.

CHANNEL DISPLAY FUNCTION

When this function is switched ON, the transceiver selects **Memory Recall** and displays only a memory channel number instead of a frequency.

With the Channel Display function ON, memory channels can be selected using the **Tuning** control or microphone **[UP]/[DWN]** as usual. Only memory channels containing data can be selected.

Press **[REV]+ POWER ON**.

- The Display shows channel numbers instead of frequencies for both bands. A "U" appears on the right side of the Display as a reminder that this is the channel number associated with the UHF band.

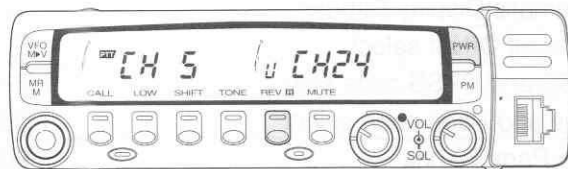

Repeat the procedure to switch the Channel Display function OFF.

The following functions can be used while Channel Display is activated:

Functions Usable with Channel Display	Page Ref.
Time-operated/ Carrier-operated Scan Resume	67
Memory Recall	44
Memory Scan	68
Memory Lock-out	68
Call channel recall	45
S-meter Squelch	28
Transmit power select	39
Display Dimmer select	78
Automatic Display Dimmer	79
Transmit Offset select	58
DTSS and DTSS code select	89
Page and Page code select	93
Auto Page Cancel	98
DTSS/ Page Delay for repeaters	91, 97
Tone and CTCSS	60, 87
Automatic Tone Frequency ID	88
Tone Alert	99
Tone/ CTCSS frequency select	61, 87
Reverse	59
Automatic Signal Check (ASC)	60
Mute	74

Functions Usable with Channel Display	Page Ref.
Automatic Band Change (A.B.C.)	73
Control band select	29
VHF/VHF or UHF/UHF configuration	30
VHF and UHF Band select	29
Band Display blanking	32
Tuning control	13
Microphone [PTT]	39
DTMF memory store	63
Tone Alert alarm tone select	100
Microphone Keypad Confirmation Tones	63
Microphone PF keys store ([PF], [VFO], [MR], [CALL])	82

INITIALIZING MEMORY

If your transceiver seems to be malfunctioning, initializing the transceiver may resolve the problem.

There are several methods of initializing or resetting the transceiver.

- Partial Reset – Single Band
- Partial Reset – Both Bands
- Full Reset excluding Programmable Memory
- Full Reset including Programmable Memory

Note: See "RESETTING PROGRAMMABLE MEMORY" {page 56} if you want to initialize the Programmable Memory only.

■ Partial Reset - Single Band

This reset initializes settings on a single band only.

Press **[VFO]+[BAND SEL]+ POWER ON**.

- Only the band corresponding to the **[BAND SEL]** pressed resets to default settings. Functions that cannot be set independently for each band are not reset. The following drawing illustrates the 144 MHz band being reset.

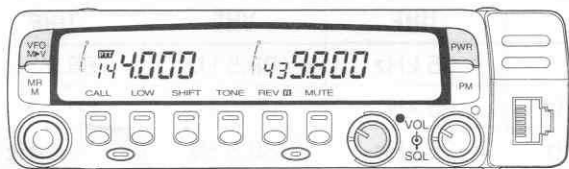

The following items are not reset:

- Microphone PF keys
- Beep function
- Automatic Band Change (A.B.C.)
- Lock
- Mute
- Time-out Timer (TOT)
- Automatic Page Cancel
- Display Demonstration mode
- Display Dimmer
- Transmit band
- Control band
- Repeater Delay time for DTSS and Page operation

Note: After the reset, the RD output remains connected to the band used last. If the RD output is not connected to the band you want, press **[BAND SEL]** for that band.

■ Partial Reset - Both Bands

This reset initializes all settings on both bands except the memory channels, the Call channels, the Page code channels, and the Programmable Memory channels.

Press **[VFO]+ POWER ON**.

- Hold **[VFO]** until a beep is heard after the power is switched ON.

■ Full Reset excluding Programmable Memory

This reset initializes everything possible on the transceiver except the Programmable Memory channels {page 51}. After using this function, all memory channels as well as all other programmable data excluding Programmable Memory channel data must be re-entered.

1 Press **[MR]+ POWER ON**.

- The Programmable Memory channel numbers begin blinking. The following blinking confirmation message appears: "OK?OK-MR KEY".

2 Press **[F]**.

- The Programmable Memory channel numbers on the Display disappear.

3 Press **[MR]**.

- The transceiver beeps and resets.
- Press any other button to cancel the function.

■ Full Reset including Programmable Memory

This reset initializes everything possible on the transceiver. After using this function, all memory channels and Programmable Memory channels {page 51} as well as all other programmable data must be re-entered.

1 Press **[MR]+ POWER ON**.

- The Programmable Memory channel numbers begin blinking. The following blinking confirmation message appears: "OK?OK-MR KEY".

2 If you're sure you want to reset everything, press **[MR]**.

- The transceiver beeps and resets.
- Press any other button except **[F]** to cancel the function.

Version	TM-733 Defaults					
	VFO Frequency		Frequency Step		Tone Frequency	
	VHF	UHF	VHF	UHF	VHF	UHF
Canada/U.S.A.	144.000 MHz	440.000 MHz	5 kHz	25 kHz	88.5 Hz	88.5 Hz
Europe	144.000 MHz	430.000 MHz	12.5 kHz	25 kHz	1750 Hz	1750 Hz
General	144.000 MHz	430.000 MHz	12.5 kHz	25 kHz	88.5 Hz	88.5 Hz

PROGRAMMABLE MEMORY (PM)

Programmable Memory Channel mode is similar to Memory Channel mode except that Programmable Memory is more powerful. This function allows you to store virtually every parameter associated with a particular communications channel for quick recall of a complete environment. If you're the type who likes the many features offered by modern transceivers, but dislikes remembering how to input all the data necessary to use the features, you will find Programmable Memory particularly useful.

PROGRAMMABLE INFORMATION

This section compares the parameters that a memory channel can store versus a Programmable Memory channel to provide a clearer picture of the difference between the two.

■ Memory Channel Storage

- Transmit and receive frequencies
- Frequency step size
- Tone/CTCSS frequency
- Tone or CTCSS status
- Transmit offset, Reverse status
- DTSS code, DTSS status

■ Programmable Memory Channel Storage

- Transmit/receive frequency
- Squelch mode and status
- Frequency step size
- Transmit and Control bands
- VHF/VHF or UHF/UHF simultaneous receive
- Programmable VFO limits
- Transmit output power
- Time-out Timer (TOT) status
- Automatic Simplex Checker (ASC) status
- Tone/CTCSS frequency
- Tone or CTCSS status
- Transmit offset, Reverse status
- Microphone DTMF keypad confirmation status
- Time-operated or Carrier-operated Scan status
- Advanced Intercept Point (AIP) status
- Automatic Band Change (A.B.C.) status
- Automatic Power Off (APO) status
- Automatic Mute status
- Display dimmer and Beep level settings
- DTSS code, DTSS/Page status and delay
- Tone Alert alarm type and status
- Packet transmit rate

APPLICATION EXAMPLES

The following are examples of how you might use Programmable Memory. These examples may not represent applications useful to you, but they illustrate the flexibility of this feature. They should encourage you to use Programmable Memory for your own applications.

Problem: You find it is impossible to set up and use a function on the transceiver even though you believe you are following the instructions detailed in this manual.

Solution:

- You could continue to explore why you cannot use the function and eventually resolve the difficulty but waste more time, or
- You could do a Full Reset and lose the contents of all your memory channels that you programmed, or
- You could simply recall Programmable Memory channel 1 that contains an exact copy of the transceiver default environment (less Page codes, DTMF memory, and microphone [PF] key programming) without losing the contents of any memory channels.

Problem: You share your transceiver with other members in your family or club. However, each individual has personal preferences for how they like to set features such as Tone Alert alarm type and status, A.B.C., Mute, Squelch, VHF/VHF or UHF/UHF simultaneous receive, etc. You have to keep changing many settings each time you use the transceiver.

Solution:

- There are 6 Programmable Memory channels. Shared among 3 people, each person could program 2 status memories with their most commonly used frequencies and other preferred settings. The result is that each person gets to use their customized environment by recalling a Programmable Memory channel without wasting time and effort to change various parameters each time they operate. This also avoids having a feature-rich transceiver but never using the features since it's too much trouble to set up the features after somebody else has been at the controls.

Problem: While operating mobile on the way to work each morning, you prefer a silent transceiver that doesn't interrupt the morning calm and you feel the Display illumination is a waste of electricity in the bright sunlight. At night when driving home, you've come to realize the Beep function truly serves a purpose, and you acknowledge it's nice to see the display after dark.

Solution:

- By using 2 of the Programmable Memory channels programmed with the same operating data such as frequency, transmit offset, CTCSS code, etc. but with different environment settings for the Dimmer and Beep functions, you can quickly recall the best settings for day or night operating.

STORING DATA IN PROGRAMMABLE MEMORY

To store any data in a Programmable Memory channel, the following must be true:

- The transceiver is in VFO mode.
- The Channel Display {page 47} function is not being used.
- Scan is not being used on either band.
- Both bands are in the Receive mode.

If all of the above are true, you can proceed with the procedure below.

- 1 Select the desired band, frequency, and associated data (Tone, CTCSS, DTSS, etc.) using VFO mode.
- 2 Press **[F]**, **[PM]** to select Programmable Memory Storage.
 - The Programmable Memory channel numbers appear in place of the button functions on the Display.



- 3 On the Front Panel, press one of the buttons **[1]** through **[6]** that corresponds to the Programmable Memory channel into which you want to store the data selected in Step 1.
 - Pressing any other button cancels Programmable Memory Storage.
 - The selected frequency and associated data are stored in the Programmable Memory channel.
 - If the Programmable Memory channel selected already contained data, the new data overwrites the previous data.
 - The previous mode is restored.

Note:

- ◆ To clear the contents of a single Programmable Memory channel, first switch to VFO mode then erase the channel.
- ◆ To clear the contents of all Programmable Memory channels, follow the Programmable Memory Reset procedure on page 56.

USING PROGRAMMABLE MEMORY

The following diagram outlines generally how to access the data in Programmable Memory channels.

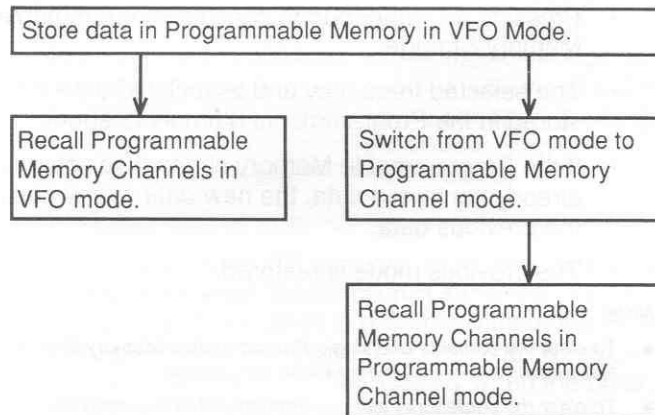

RECALLING PROGRAMMABLE MEMORY CHANNELS (VFO MODE)

1 Press **[PM]**.

- The Programmable Memory channel numbers appear in place of the button functions on the Display.
- The contents of the Programmable Memory channel used last appear on the Display, and the selected Programmable Memory channel number is bracketed by a blinking "◀▶".

2 Press one of the Front Panel buttons **[1]** through **[6]** that corresponds to the Programmable Memory channel that you want to recall.

- The contents of the recalled Programmable Memory channel are transferred to the VFO.
- Pressing a button for a Programmable Memory that contains no data cancels Memory Recall.
- Pressing any other button cancels Programmable Memory Recall.

RECALLING PROGRAMMABLE MEMORY CHANNELS (PROGRAMMABLE MEMORY CHANNEL MODE)

■ Direct Method

- 1 Press **[PM]+ POWER ON** to toggle Programmable Memory Channel mode ON or OFF.
 - When Programmable Memory Channel mode is ON, the Programmable Memory channel numbers appear in place of the button functions on the Display.
 - The contents of the Programmable Memory channel used last appear on the Display, and the selected Programmable Memory channel number is bracketed by a "◀▶".
- 2 Press one of the Front Panel buttons **[1]** through **[6]** that corresponds to the Programmable Memory channel that you want to recall.
 - The recalled Programmable Memory channel is bracketed by "◀▶", and the transceiver is now functional using the settings stored in the selected memory.
 - This step is not necessary if you plan to use the same channel that was used just prior to switching the transceiver power OFF.

■ Tuning Control Method

- 1 Press **[PM]+ POWER ON** to toggle Programmable Memory Channel mode ON or OFF.
 - When Programmable Memory Channel mode is ON, the Programmable Memory channel numbers appear in place of the button functions on the Display.
 - The contents of the Programmable Memory channel used last appear on the Display, and the selected Programmable Memory channel number is bracketed by a "◀▶".
- 2 Turn the **Tuning** control, or press microphone **[UP]/[DWN]**, to move the "◀▶" so it surrounds the Programmable Memory channel that you want to recall.
 - The transceiver is now functional using the settings stored in the selected memory.
 - Programmable Memory channels that contain no data are jumped over as you select a channel.
 - This step is not necessary if you plan to use the same channel that was used just prior to switching the transceiver power OFF.

Note: When in Programmable Memory Channel mode, you cannot modify or erase Programmable Memory channels.

ERASING PROGRAMMABLE MEMORY CHANNELS (VFO MODE ONLY)

1 Press [F]+[PM].

- The Programmable Memory channel numbers appear in place of the button functions on the Display.
- The contents of the Programmable Memory channel used last appear on the Display, and the selected Programmable Memory channel number is bracketed by a blinking "◀▶".

2 Turn the **Tuning** control, or press microphone [UP]/[DWN], to move the "◀▶" so it surrounds the Programmable Memory channel that you want to erase.

- The Display shows the contents of each Programmable Memory channel as it is selected.
- Programmable Memory channels that contain no data are jumped over as you select a channel.

3 Press one of the Front Panel buttons [1] through [6] that corresponds to the bracketed Programmable Memory channel selected in Step 2.

- The following blinking confirmation message appears: "OK?OK-MR KEY".
- Pressing a button for a Programmable Memory channel that contains no data causes an alarm tone and the erase function is canceled.

4 Press [MR].

- Contents of the selected Programmable Memory channel are erased.
- Pressing any button other than [MR] cancels the erase function without clearing any Programmable Memory channel.

Note: You cannot erase Programmable Memory 1.

RESETTING PROGRAMMABLE MEMORY (VFO MODE ONLY)

1 Press [F]+[PM]+ POWER ON.

- The Programmable Memory channel numbers appear blinking in place of the button functions on the Display and the following blinking confirmation message appears: "OK?OK-MR KEY".
- Pressing a button for a Programmable Memory channel that contains no data causes an alarm tone and the erase function is canceled.

2 Press [MR].

- Contents of all Programmable Memory channels are erased. Programmable Memory channel 1 is returned to its factory default settings.
- Pressing any button other than [MR] cancels the reset function and restores VFO mode without resetting any channels.

OPERATING THROUGH REPEATERS

Compared to simplex communication, you can usually transmit over much greater distances by using a repeater. Repeaters are typically located on a mountain top or other elevated location. Often they operate at higher ERP (Effective Radiated Power) than a typical base station. This combination of elevation and high ERP allows communications over considerable distances.

Repeaters are often installed and maintained by radio clubs, sometimes with the cooperation of local businesses from communications industries. During emergencies, repeater networks can be a valuable aid to officials responsible for coordinating communications in a community.

TRANSMIT OFFSETS

All Amateur Radio voice repeaters use a separate receive and transmit frequency. The transmit frequency may be higher or lower than the receive frequency but the difference in frequencies will be a standard amount, or "standard split". Most repeater configurations fall into one of the following categories:

Offset Direction	TM-733A/E VHF	TM-733A UHF	TM-733E UHF
+	+ 600 kHz	+ 5 MHz	+ 1.6 MHz
-	- 600 kHz	- 5 MHz	- 1.6 MHz
--	N/A	N/A	- 7.6 MHz

N/A: Not applicable

Whether using VFO mode, Memory Recall, or the Call channel, the transmit offset direction can be changed. If using a split memory channel or split Call channel, Transmit Offset cannot be changed.

SELECTING OFFSET DIRECTION

This function sets the transmit frequency either higher (+) or lower (-) than the receive frequency by a fixed amount.

- 1 Press **[BAND SEL]** to select your desired band.
- 2 Press **[SHIFT]**.
 - The default is "simplex" (no offset).
 - Each press of **[SHIFT]** changes the offset as follows:

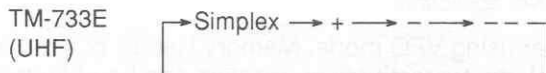
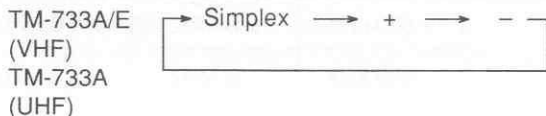

If the offset transmit frequency falls outside the transmit band, transmit is inhibited until the transmit frequency is brought within the band limits by one or more of the following methods:

- Move the receive frequency further inside the band.
- Reverse the offset direction.

AUTOMATIC TRANSMIT OFFSET

On some versions as explained below, the transceiver takes care of setting the required transmit offset automatically when you select a frequency in VFO mode on the 144 MHz band. Due to Automatic Offset, a manually assigned offset direction is only effective until the frequency is changed.

■ U.S.A. and Canada Versions

Automatic Offset for the TM-733A sold in these markets is programmed according to the standard ARRL (American Radio Relay League) Band Plan for repeater offset direction. You can override this programming by following the "SELECTING OFFSET DIRECTION" procedure in the preceding section. Contact your national Amateur Radio association to obtain up-to-date band plans that explain band usage by mode and activity.

144.0 145.5 146.4 147.0 147.6
145.1 146.0 146.6 147.4 148.0 MHz

S	-	S	+	S	-	+	S	-
---	---	---	---	---	---	---	---	---

S: Simplex

■ European Versions

TM-733E Automatic Offset is programmed as follows:

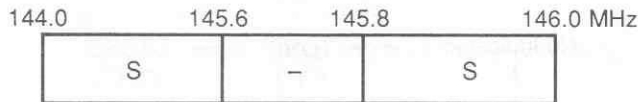

S: Simplex

■ Canceling Automatic Offset

There may be times when you don't want the Automatic Offset function to be active. For example, in your specific area, it is possible that national band plans are not in effect and it would be inconvenient if the transceiver kept assigning an offset automatically which you did not require. Or, when traveling with your transceiver in other countries, it may be more convenient to manually assign an offset if required.

Therefore, to disable Automatic Offset, press **[VFO]+[REV]+ POWER ON**.



Repeat this procedure to activate the function again.

REVERSE FUNCTION

When used while monitoring a repeater, the Reverse function allows you to manually check the signal strength of a station accessing the repeater. If the station's signal is strong, it's best to move to a simplex frequency to continue the contact and free-up the repeater.

Press **[REV]** to toggle the Reverse function ON or OFF.

- The receive frequency and the transmit frequency on the selected band are exchanged. "R" appears when the function is ON. The default is OFF.



- If reversal would place the receive frequency outside the receive frequency range, an error beep sounds when **[REV]** is pressed. No reversal occurs.
- If the transmit frequency would go out of the transmit frequency range if **[PTT]** were pressed, then pressing **[PTT]** causes an error beep and Receive is selected.
- Reverse cannot be activated while **[PTT]** is held down.
- Automatic Offset does not function while Reverse is ON.

■ Automatic Simplex Checker (ASC)

The Automatic Simplex Checker function was developed as an enhancement of the Reverse function. ASC automatically monitors the signal strength on the repeater input frequency of the station you are contacting. If their signal strength is high enough to allow direct communication without a repeater, an indicator on the Display begins blinking. This alerts you to move off to a private frequency and release the repeater for other users.

Press **[REV] (1 s)** to switch the ASC function ON.

- A reverse video "R" appears above the operating frequency when the function is switched ON. If direct communication is possible without the repeater, the "R" begins blinking. The "R" stops blinking and remains ON steadily when the other station's signal is too weak for direct contact without a repeater.
- The default is OFF.

To cancel ASC, press **[REV]**.

Note:

- ◆ *ASC does not function if your transmit and receive frequencies are the same (simplex operation). The reverse video "R" remains ON.*
- ◆ *While ASC is functioning, receiver audio is momentarily interrupted approximately every 3 seconds to allow automatic checking to take place.*
- ◆ *ASC can also be used after a split memory channel has been recalled.*

■ TONE ACCESS

Each press of **[TONE]** switches the Tone function as follows on the selected band:

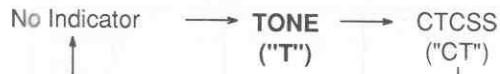

- The CTCSS indicator does not appear if the CTCSS unit is not installed.
- On European versions, a Tone frequency other than 1750 Hz must be selected.

No indicator	Subaudible tone is not transmitted.
TONE	Subaudible tone is transmitted.

■ Selecting a Tone Frequency

Often a Tone frequency is required to access repeaters. For example, 88.5 Hz may be needed in the U.S.A. or Canada, and 1750 Hz is used in Europe. The Tone frequencies listed below can be selected.

No.	Freq. (Hz)	No.	Freq. (Hz)	No.	Freq. (Hz)	No.	Freq. (Hz)
01	67.0	11	97.4	21	136.5	31	192.8
02	71.9	12	100.0	22	141.3	32	203.5
03	74.4	13	103.5	23	146.2	33	210.7
04	77.0	14	107.2	24	151.4	34	218.1
05	79.7	15	110.9	25	156.7	35	225.7
06	82.5	16	114.8	26	162.2	36	233.6
07	85.4	17	118.8	27	167.9	37	241.8
08	88.5	18	123.0	28	173.8	38	250.3
09	91.5	19	127.3	29	179.9	(39) ¹	(1750)
10	94.8	20	131.8	30	186.2		

¹ European versions only

The following procedure allows you to select any of the available tones.

- 1 Press **[BAND SEL]** to select your desired band.
- 2 Press **[F] (1 s)**, **[T.SEL]**.
 - The current Tone frequency appears.



- 3 Turn the **Tuning** control, or press microphone **[UP]/[DWN]**, to select a Tone frequency.
 - Alternatively, if your microphone is equipped with a DTMF keypad, you can enter the Tone number by direct entry from the microphone. Refer to page 85 for more information.
 - 1750 Hz can be selected only on the European versions. When 1750 Hz is selected, the Tone and CTCSS functions switch OFF automatically. As soon as any other Tone frequency is selected, the Tone and CTCSS functions switch back to their previous settings.
- 4 Press **[MHz]** or microphone **[PTT]** to store the frequency and return to the previous mode.

■ European Versions

After selecting 1750 Hz, a 1750 Hz tone is transmitted on the Transmit band as long as **[TONE]** is held down; it's not necessary to press **[PTT]**. This tone cannot be sent when the transmitter is inhibited such as if the transmit frequency falls outside the Amateur band. "T" appears while 1750 Hz is being transmitted by pressing **[TONE]**. Even if the DTSS function {page 89} is ON, DTMF signals are not transmitted at this time.

Transmit Hold for sending the 1750 Hz repeater access tone can be activated as explained below. With this function ON, pressing **[TONE]** sends the 1750 Hz repeater access tone for 2 seconds continuously.

Press **[CALL]+[TONE]+ POWER ON** to toggle Transmit Hold for the 1750 Hz tone ON or OFF.

- "ON" appears briefly on the lower right corner of the Display when the function is switched ON. The default is OFF.

DUAL TONE MULTI-FREQUENCY (DTMF) FUNCTIONS

The following DTMF functions require an MC-45DM DTMF microphone or a TH-7 transceiver.

The keypads on these microphones and the TH-7 transceiver include the 12 keys found on a push-button telephone plus an additional 4 keys (A, B, C, D). These additional keys are required for various control operations by some repeater systems.

■ Making DTMF Calls

To make a DTMF call, hold down the microphone **[PTT]** and press **[0]** to **[9]**, **[A]**, **[B]**, **[C]**, **[D]**, **[*]**, or **[#]**.

- The corresponding DTMF tones are transmitted.



MC-45DM

■ Microphone Keypad Confirmation Tones

When using the microphone with any of the DTMF functions, you can activate this function which produces feedback tones to confirm that you are actually pressing the keys on the keypad.

Press **[PTT]+[DWN]+ POWER ON** to toggle this function ON or OFF.

- "ON" appears briefly on the lower right corner of the Display when the function is switched ON. The default is OFF.
- You will now hear a short confirmation tone after each keypad key is pressed.
- Beep Tone {page 77} must be ON for this function to work.



Note: After switching this function ON, DTSS and Page codes cannot be received on the other band.

■ Storing DTMF Numbers for the Automatic Dialer

Audible DTMF tones from other transceivers near you may be picked up by your MC-45DM or TH-7 microphone element. If so, this could prevent the following function from working correctly.

To store a DTMF number up to a maximum of 15 digits in any of 10 dedicated DTMF memories, follow the procedure below:

1 Press **[F]+[CALL]+ POWER ON**.

- "P ---" appears.



2 Enter the digits of the number to be stored using the keypad.

- If you enter an incorrect digit, press microphone **[VFO]** to erase all digits entered, and start again.
- The non-numeric keys are displayed as follows:
[A]: A, **[B]:** b, **[C]:** C, **[D]:** d, **[*]:** E, **[#]:** F

- 3 Press microphone [PF].
 - The last 3 digits entered are visible.



- 4 Press a single key [0] to [9] to store the number in a DTMF memory.
 - The Display reverts to "P ---" ready for the next DTMF number to be stored.
- 5 Press microphone [PTT] to return to the previous mode.

■ Confirming Stored DTMF Numbers

- 1 Press [F]+[CALL]+ POWER ON.
 - "P ---" appears.

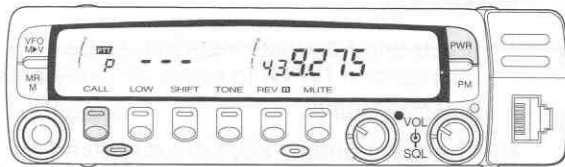

- 2 Press microphone [MR].

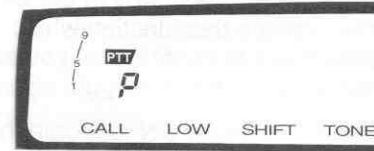

- 3 Press a single key [0] to [9] to recall the contents of the DTMF memory desired.
 - The number contained in the recalled memory scrolls across the Display accompanied by DTMF tones from the speaker if the Beep function is switched ON.
- 4 Press microphone [PTT] to return to the previous mode.

■ Transmitting Stored DTMF Numbers (Automatic Dialer)

To transmit a stored DTMF number, follow the procedure below:

- 1 Press [BAND SEL] to select your desired band.
- 2 Press [PTT]+[PF].
 - "P" appears.

3 Press a single key [0] to [9] for the DTMF memory that contains the number that you want to transmit.

- The number contained in this DTMF memory is transmitted, then the transceiver returns automatically to Receive.

■ Autopatch (U.S.A. and Canada Versions)

Some repeaters in the U.S.A. and Canada offer a service called Autopatch. This application of the DTMF function allows you to access the public telephone network from your transceiver. This repeater function can be very convenient, and can even save lives when used appropriately during emergencies.

- 1 Press and hold [PTT].
- 2 Press the keys on the keypad in sequence to send DTMF tones.
 - Your transceiver remains in the transmit state for 2 seconds after pressing each key. This means you can release [PTT] after beginning to press keys without interrupting the DTMF transmission.

Note: Some repeaters require a special key sequence to activate Autopatch. Check with the repeater control operator.

DTMF Tones

Freq (Hz)	1209	1336	1477	1633
697	1	2	3	A
770	4	5	6	B
852	7	8	9	C
941	*	0	#	D

SCAN

Scan is a useful feature for hands-off monitoring of your favorite frequencies. After becoming comfortable with how to use all types of Scan, the monitoring flexibility gained will increase your operating efficiency.

This transceiver provides 7 types of Scan as follows:

Scan Type	Purpose
Memory Scan	Quick activity update of your favorite frequencies.
Band Scan	General update on band activity.
Programmable Band Scan	Similar to Band Scan except over a narrower segment of the band.
MHz Scan	Scan all frequencies within a 1 MHz range.
Call/VFO Scan	Monitor the Call channel plus any VFO frequency.
Call/Memory Scan	Monitor the Call channel plus your favorite frequency.
Programmable Memory Scan	Scans only the Programmable Memory channels while in Programmable Memory Channel mode.

Note:

- ◆ Remember to adjust the squelch threshold level {page 27} before using Scan.
- ◆ Always turn OFF Tone Alert {page 99}, Monitor {page 83}, and Page {page 92} before using Scan.
- ◆ When using S-meter Squelch, Scan stops when the received signal strength matches or exceeds the S-meter setting. Scan resumes 2 seconds after the signal level drops below the S-meter setting.
- ◆ For CTCSS operation {page 87}, Scan stops and the squelch opens only for signals that contain the same CTCSS tone that is stored in your transceiver.
- ◆ For DTSS operation {page 89}, Scan stops for any signal received; however, the squelch opens only for signals that contain the same DTSS code that is stored in your transceiver.
- ◆ When both CTCSS and DTSS are ON, Scan stops for signals that contain the matching CTCSS tone. However, the squelch opens only when the matching DTSS code is received.

SCAN RESUME METHODS

Before using Scan, it's necessary to decide under what condition you want your transceiver to continue scanning after detecting and stopping for a signal. You can choose Time-operated Scan or Carrier-operated Scan. The default is Time-operated Scan.

■ Time-Operated Scan

Your transceiver stops scanning after detecting a signal, remains there for approximately 5 seconds, and then continues to scan even if the signal is still present.

■ Carrier-Operated Scan

Your transceiver stops scanning after detecting a signal and remains on the same frequency until the signal drops out. There is a 2 second delay between signal drop-out and scan resumption to allow time for any responding stations to begin transmitting.

Note:

- ◆ Turning the **Tuning** control clockwise or pressing microphone **[UP]** after a signal that has stopped Scan clears, causes scanning to resume immediately upward.
- ◆ Turning the **Tuning** control counterclockwise, or pressing microphone **[DWN]** after a signal that has stopped Scan clears, causes scanning to resume immediately downward.

SELECTING SCAN RESUME METHOD

Use the following procedure to switch your transceiver between Time-operated Scan and Carrier-operated Scan.

- 1 Press **[BAND SEL]** to select your desired band.
- 2 Press **[F] (1 s)**, **[VFO]** to switch between Time-operated Scan and Carrier-operated Scan on the selected band.
 - When Carrier-operated Scan is selected, "CO" appears. The default is Time-operated Scan.



- 3 Repeat Step 2 to switch to the opposite Scan Resume method.

MEMORY SCAN

Memory Scan allows all memory channels containing data to be scanned.

- 1 Press **[BAND SEL]** to select the band that contains the memory channels that you want to scan.
- 2 Press **[MR] (1 s)**.
 - The 1 MHz decimal and the **[CONT SEL]** indicator blink while scanning is in progress. The default direction is upward through the channels.
 - Scan starts with the channel last recalled, then scans through the memory channels in the same direction last used for scanning.
- 3 To reverse the scan direction, turn the **Tuning** control or press microphone **[UP]/[DWN]**.
 - Upward scan:
Turn **Tuning** control clockwise, or
Press microphone **[UP]**.
 - Downward scan:
Turn **Tuning** counterclockwise, or
Press microphone **[DWN]**
- 4 To cancel Memory Scan, press **[BAND SEL]** for the band being scanned or **[PTT]**.

Note: At least 2 or more memory channels must contain data and the squelch must be closed for scan to function.

■ Locking-Out Memory Channels

Memory channels that you prefer not to monitor while scanning can be locked-out. Lock-out any memory channel with the following procedure:

- 1 Press **[BAND SEL]** to select the band that contains the memory channels that you want to lock-out.
- 2 Press **[MR]** to select Memory Recall.
- 3 Select the memory channel to be locked-out using the **Tuning** control or microphone **[UP]/[DWN]**.
- 4 Press **[F] (1 s)**, **[MR]** to lock-out the selected channel.
 - A "star" appears below the memory channel number to indicate the channel has been locked-out.
 - By default, all memory channels are not locked-out.



Lock-out for an individual channel can be canceled by repeating the above procedure.

BAND SCAN

Band Scan allows you to scan all frequencies from the lowest frequency to the highest frequency on each band. The current frequency step size for each band is used.

- 1 Press **[BAND SEL]** to select the band that you want to scan.
- 2 Press **[VFO] (1 s)**, and Scan starts at the frequency currently displayed.
 - The 1 MHz decimal and the **[CONT SEL]** indicator blink while scanning is in progress. The default direction is downward in frequency.
 - The scan direction is the same as last used. If the **Tuning** control is turned, or microphone **[UP]** or **[DWN]** is pressed after using Scan, the scan direction may be different next time Scan is used.

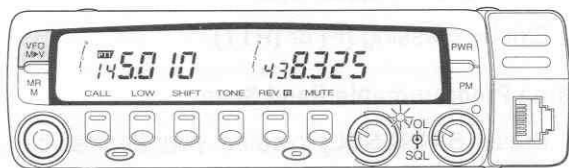

- 3 To reverse the scan direction, turn the **Tuning** control or press microphone **[UP]/[DWN]**.
 - Upward scan:
Turn **Tuning** control clockwise, or
Press microphone **[UP]**.
 - Downward scan:
Turn **Tuning** counterclockwise, or
Press microphone **[DWN]**
- 4 To cancel Band Scan, press **[BAND SEL]** for the band being scanned or **[PTT]**.

Note: Squelch must be closed for Scan to function (page 27).

PROGRAMMABLE BAND SCAN

This type of scan is similar to Band Scan except the programmable aspect allows you to set scan limits to limit the frequency range of the scan.

■ Setting Scan Limits

- 1 Press **[BAND SEL]** to select your desired band.
- 2 Press **[F]+[VFO]**.
 - "L" and the current lower limit appear. The default is the currently selected frequency.



- 3 Turn the **Tuning** control, or press microphone **[UP]/[DWN]**, to display the desired lower limit.
 - Press **[MHz]** if you want to change the frequency in 1 MHz steps.
- 4 Press **[MR]** to store the lower limit.
 - "U" and the current upper limit appear. The default is the currently selected frequency.
- 5 Turn the **Tuning** control, or press microphone **[UP]/[DWN]**, to display the desired upper limit.

- 6 Press **[MR]** to store the upper limit.
 - The previous mode is restored.

Note:

- ◆ The lower limit must be lower in frequency than the upper limit.
- ◆ The lower and upper frequency steps must be equal.
- ◆ Selections must be made within 10 seconds or the previous mode is restored.

■ Confirming the Programmable Limits

- 1 Press **[BAND SEL]** to select the band on which you want to confirm the limits.
- 2 Press **[F]+[VFO]**.
 - This is the lower limit
- 3 Press **[MR]**.
 - This is the upper limit.
- 4 Exit by pressing **[F]** or **[PTT]**.

■ Using Programmable Band Scan

- 1 Press **[BAND SEL]** to select your desired band.
- 2 Select a frequency equal to or between the programmed scan limits.
 - If you select a frequency that is outside the programmed scan limits, the transceiver will start Band Scan automatically in the next step instead of Programmable Band Scan.

- 3 Press **[VFO] (1 s)**, and Scan starts at the frequency currently displayed.
 - The decimal starts blinking to indicate scanning is in progress.
 - The scan direction is the same as last used. If the **Tuning** control is turned, or microphone **[UP]** or **[DWN]** is pressed after using Scan, the scan direction may be different next time Scan is used.
 - The default direction is upward in frequency.
- 4 To reverse the scan direction, turn the **Tuning** control, or press microphone **[UP]/[DWN]**.
 - Upward scan:
Turn **Tuning** control clockwise, or
Press microphone **[UP]**.
 - Downward scan:
Turn **Tuning** counterclockwise, or
Press microphone **[DWN]**
- 5 To cancel Programmable Band Scan, press **[BAND SEL]** for the band being scanned or **[PTT]**.

Note: Squelch must be closed for Scan to function {page 27}.

MHZ SCAN

MHz Scan allows you to scan a 1 MHz segment of the band. The current 1 MHz digit determines the limits of the scan. For example, if the current frequency is 438.400 MHz, then MHz Scan would scan from 438.000 MHz to 438.975 MHz. The exact upper limit depends on the step size selected.

While using either Band Scan {page 69} or Programmable Band Scan {page 70}, press **[MHz]** to start or stop MHz Scan.

- Stopping MHz Scan while the current frequency is equal to or between the limits of Programmable Band Scan causes Programmable Band Scan to resume. Otherwise, Band Scan resumes.

CALL/VFO SCAN

Use Call/VFO scan to monitor both the Call channel and the current VFO frequency on the selected band.

- 1 Press **[BAND SEL]** to select your desired band.
- 2 Press **[VFO]** to select VFO mode.
- 3 Press **[CALL] (1 s)**.
- 4 To cancel Call/VFO Scan, press **[BAND SEL]** for the band being scanned or **[PTT]**.

CALL/MEMORY SCAN

Use Call/Memory Scan to monitor both the Call channel and the memory channel last used on the selected band.

- 1 Press **[BAND SEL]** to select your desired band.
- 2 Press **[MR]** to select Memory Recall mode.
- 3 Press **[CALL] (1 s)**.
- 4 To cancel Call/Memory Scan, press **[BAND SEL]** for the band being scanned or **[PTT]**.

PROGRAMMABLE MEMORY SCAN

Use Programmable Memory Scan to monitor the Programmable Memory channels you have programmed. This function only works while in Programmable Memory Channel mode {page 51}, and non-programmed channels are skipped.

The scan progresses cyclically as shown below:

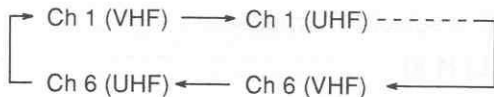

- 1 Press **[PM]+ POWER ON** to select Programmable Memory Channel mode {page 55}.

- 2 Press **[PM] (1 s)**.

- The "**◀▶**" moves across the Programmable Memory channel numbers as the scan progresses.

- 3 To cancel Programmable Memory Scan, press either the left or right **[BAND SEL]**, or **[PTT]**.

AUXILIARY FUNCTIONS

The functions described in this section are called "auxiliary" since none of the functions are mandatory to use in order to contact other stations. Nevertheless, each function contributes toward making the transceiver enjoyable to use.

AUTOMATIC BAND CHANGE (A.B.C.)

A.B.C. automatically but temporarily switches the Receive only band to be the Transmit band after a signal is received on the Receive only band that opens the squelch. This makes it easy to reply to a caller without any need for manually selecting the correct band.

Press **[F]**, **[A.B.C.]** to toggle the A.B.C. function ON or OFF.

- "A.B.C." appears when the A.B.C. function is ON.



- On receipt of a signal, the "PTT" indicator moves to the band on which the signal was received making this the Transmit band. The indicator blinks 3 times.
- You have about 2 seconds to press **[PTT]** to return a call to the calling station after his carrier drops, otherwise the original Transmit/Receive band configuration is restored. The A.B.C. function still remains active.
- Pressing either **[BAND SEL]** cancels A.B.C.
- After using both A.B.C. and Tone Alert together, you can cancel the functions quickly from the microphone. Press **[PTT]** once to cancel Tone Alert, then press **[PTT]** a second time to cancel A.B.C. The band that is the Transmit band at the time that A.B.C. is canceled, remains the Transmit band after A.B.C. is switched OFF.

ADVANCED INTERCEPT POINT (AIP)

AIP helps eliminate interference and reduce audio distortion caused by intermodulation. This problem is often apparent in urban centers when the receive band is extremely crowded. Switch the AIP function ON as an aid in fighting this problem of communications congestion.

- 1 Press **[BAND SEL]** to select your desired band.
- 2 Press **[F]+[A.B.C.]** to toggle the AIP function ON or OFF.
 - "ON" appears briefly on the lower right corner of the Display when the function is switched ON. The default is OFF.
 - The 10 kHz decimal point on the selected band appears when AIP is ON.



Note: If you are using either the VHF/VHF or UHF/UHF configuration {page 30} and you want to activate AIP, press **[CONT SEL]** to make the Control band the band that is not displaying the V^2 or U^2 indicators. AIP becomes active on both bands simultaneously when the AIP function is switched ON in these configurations.

MUTE

Mute is useful when monitoring both bands simultaneously. If a signal is received on the Transmit band that opens the squelch, this function temporarily mutes the audio from the other band. This makes it easier to hear the station that's calling on the Transmit band. When the squelch closes on the Transmit band, the audio level on the Receive only band returns to normal.

Similarly, activating this function mutes the audio from the Receive only band while you are transmitting on the Transmit band.

Press **[MUTE]** to toggle this function ON or OFF.

- "MUTE" appears when the Mute function is ON.
- You can still change the Transmit band by pressing **[BAND SEL]** while using the Mute function.



LOCK

Occasionally, you may want to lock the buttons, keys, **Tuning** control, or even the operating band to prevent yourself or others from changing transceiver settings accidentally. This transceiver has several lock functions as explained in the following sections. Some application suggestions are offered to help you understand the benefits of the functions.

■ Transceiver Lock

Transceiver Lock is suitable for a typical mobile installation where you do most functions from your microphone. This mode prevents accidental changes in settings at the transceiver by others who may also be in your mobile.

Press **[F]**, **[MHz]**.

- "LOCK" appears when the Transceiver Lock function is ON. Pressing a locked button generates an alarm beep.
- Each time this key combination is pressed, Transceiver Lock toggles between ON and OFF.



Functions	Transceiver Lock	Mic. Lock	All Lock
Front Panel except:	Locked	Unlocked	Locked
[F]	Unlocked	Unlocked	Locked
[PWR]	Unlocked	Unlocked	Unlocked
VOL control	Unlocked	Unlocked	Unlocked
SQL control	Unlocked	Unlocked	Unlocked
Microphone except:	Unlocked	Locked	Locked
[PTT]	Unlocked	Unlocked	Locked
DTMF keypad (MC-45DM)	Unlocked	Unlocked	Locked

■ Microphone Lock

One application for this function could be when using the DATA connector for Packet. You may want the microphone handy for voice contacts but, in general, you don't use the control functions offered by the microphone. This function is also handy to prevent changing your transceiver settings by touching the wrong button or key on the microphone while holding it.

Use the slide switch on the microphone rear to select the Microphone Lock status.

■ All Lock

All Lock is ideal when you have no plans to transmit but you want to monitor a specific channel.

- 1 Press **[F]**, **[MHz]**.
 - "LOCK" appears.
- 2 Press **[PWR]** to switch OFF the transceiver power.
- 3 Press **[MHz]+ POWER ON**.
 - "A.LOCK" appears. Pressing a locked button generates an alarm beep.



- 4 To deactivate All Lock, press **[MHz]+ POWER ON**, then press **[F]**, **[MHz]**.

AUTOMATIC POWER OFF (APO)

Automatic Power Off is a background function that monitors whether any buttons or keys have been pressed, or whether the **Tuning** control has been turned. After 3 hours pass with no changes, APO turns OFF the power. However, 1 minute before the power turns OFF, "APO" starts blinking and a series of warning tones sound.

If the squelch opens or any settings are changed during the 3 hour period while APO is ON, the timer resets. When the squelch closes or setting changes stop, the timer begins counting again from 0. When Tone Alert is switched ON {page 99}, APO still turns OFF the power if no settings are changed for 24 hours.

- 1 Press **[F]** (1 s), **[MHz]**.
 - "APO" appears. The default is OFF.



- 2 To switch the APO function OFF, repeat Step 1.

To restore power after APO has timed out, press **[PWR]** twice.

Note:

- ◆ APO cannot be switched OFF if the Display Dimmer is switched to No Display.
- ◆ Switching the Display Dimmer to No Display while APO is OFF causes APO to be switched ON automatically.

BEEP FUNCTION

The transceiver beeps each time you press a button or key. Also, pressing **[PTT]** generates a beep any time transmission is not possible on the frequency selected. For example, the transceiver beeps when **[PTT]** is pressed while a transmit offset is selected that places the transmit frequency outside the Transmit band.

Functions that are toggled ON and OFF by the same button command are accompanied by a high beep to indicate one status, and a different beep to indicate the opposite status. If you prefer, you can vary the beep volume or cancel it altogether for silent operation.

1 Press **[F]** (1 s), **[BEEP]**.

- The current Beep status appears.

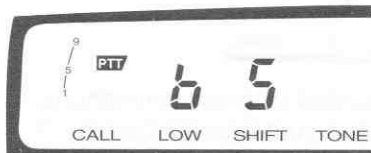

2 Turn the **Tuning** control, or press microphone **[UP]/[DWN]**, to select your desired beep volume.

- The available selections are "OFF", "b1" (quietest), "b2", "b3", "b4", "b5", "b6", and "b7" (loudest). The default is "b5".

3 Press **[MHz]** or **[PTT]**.

- The previous mode is restored.

■ Frequency Readout by Beeps

This function uses beeps of different frequencies to announce the current Control band frequency. The function can be used no matter what mode the transceiver is in as long as the Beep function is ON.

1 Press **[F]+[TONE]+ POWER ON**.

- The default is OFF.



2 Press microphone **[PF]**.

- The displayed frequency is announced via tones {page 78}.
- Reconfigure **[PF]** {page 82} to cancel this function.

Note: This function does not function while any Scan function is being used.

Example 1: 144.260 MHz

1	4	4	.	2	6	0
D	G	G		E	B	C

Example 2: 430.5125 MHz

4	3	0	.	5	1	2	5
G	F	C		A	D	E	A

Displayed Digit	Frequency (Hz)	Musical Note
0	523.248	C
1	587.328	D
2	659.248	E
3	698.464	F
4	783.984	G
5	880.000	A
6	987.770	B
7	1046.496	C
8	1174.656	D
9	1318.496	E

DISPLAY DIMMER

The Display illumination can be varied to suit the lighting conditions where you are operating. Select the brightness level that provides the best Display visibility.

If the Display Dimmer is switched to No Display, the APO function {page 76} switches ON automatically. If the APO function times out, the transceiver switches OFF. Switching ON the transceiver again restores the default brightness of "d2".

1 Press **[F]**, **[DIM]**.

- The current Display Dimmer status appears.

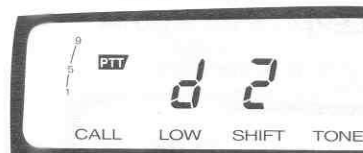

2 Turn the **Tuning** control, or press microphone **[UP]/[DWN]**, to select your desired intensity of illumination.

- The available selections are No Display, "OFF", "d4" (dimmiest), "d3", "d2", "d1" (brightest). The default is "d2". When the No Display or OFF choices are selected, the Automatic Dimmer {page 79} function switches ON automatically.

3 Press **[MHz]** or **[PTT]**.

- The previous mode is restored.

■ Auto Dimmer Change

The Display intensity can be made to increase 1 step brighter for 5 seconds (2 steps when No Display is selected) when you press a button or key, or turn the **Tuning** control. No change occurs if d1 is the current Display Dimmer setting. Also, changing the Display Dimmer selection, automatically deactivates the Auto Dimmer Change function.

The function can be manually activated when dimmer level d1, d2, d3, or d4 is selected, and the function is automatically activated when No Display or OFF dimmer levels are selected.

Press **[F]+[LOW]+ POWER ON** to toggle this function ON or OFF.

- "ON" appears briefly on the lower right corner of the Display when the function is switched ON. The default is OFF.



DISPLAY DEMONSTRATION MODE (SHOW-OFF MODE)

Initiating this mode places the transceiver in "Show-Off" mode. Various pre-programmed displays appear. These displays cannot be programmed by you, so you can enjoy those which have been programmed for you already.

The transceiver can be used in this mode, if desired. Pressing buttons or keys, or turning the **Tuning** control restores the operating Display immediately. If there is no button/key entry or **Tuning** control adjustment for more than about 10 seconds, the transceiver reverts back to Show-Off mode.

Press **[CALL]+ POWER ON** to toggle the mode ON or OFF.

- "ON" appears briefly on the lower right corner of the Display when the mode is switched ON. The default is OFF.

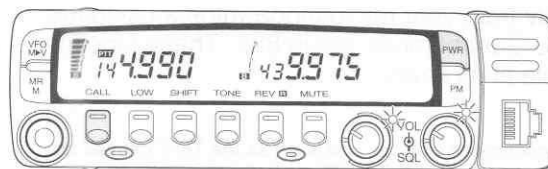

REMOTE CONTROL

This feature allows numerous transceiver functions to be changed conveniently from a microphone such as the MC-45DM without using the Front Panel buttons or controls. These microphones are equipped with a DTMF keypad that is used in conjunction with other keys and buttons on the microphone to generate the commands that control the transceiver.

Alternatively, the TH-7 Dual Bander can be used as the controller in place of a keypad-equipped microphone. The TH-7 is a compact, handy FM transceiver available in the General market only.

Be aware that audible DTMF tones from other transceivers near you may be picked up by your MC-45DM or TH-7 microphone element. If so, this could prevent the following functions from working correctly.

Later, we also explain how to use some functions remotely from your microphone without using the Remote Control mode {page 82}. These functions are available at all times.

Note:

- ◆ Connecting an external unit such as the TH-7 causes your transceiver to switch to EXT control mode. Disconnecting the external unit causes the transceiver to return to Microphone Remote Control.
- ◆ U.S.A. Version only: It is not legal to transmit control codes on the 144 MHz band. Transmit control codes only on the 440 MHz band.

ACTIVATING REMOTE CONTROL MODE

Press **[F]+[CONT SEL]** to toggle Remote Control ON or OFF.

- The S-meter on the Control band begins blinking when Remote Control is activated.
- When your transceiver is configured for Remote Control, the keypad can be used to control the functions as shown in the accompanying diagram {page 81}.



Note:

- ◆ Remote Control with an MC-45DM cannot be used while DTSS or Page is switched ON.
- ◆ To activate the functions shown in the upper half of each square in the diagram, press **[D]** first.
- ◆ When VOLUME or SQUELCH is ON, vary the volume and squelch threshold by pressing **[*]** or **[#]**.
- ◆ Both VOLUME and SQUELCH cannot be activated at the same time. Only 1 of the 2 functions can be ON at any time.
- ◆ When VOLUME and SQUELCH are OFF, pressing **[*]** or **[#]** changes the operating frequency. Also, a Tone frequency can be selected if Tone Select {page 61} is activated.

REMOTE CONTROL FUNCTIONS

	1	2	3	A
[F], [KEY]	T.ALT SEL	T.SEL	T.ALT	—
[KEY]	SHIFT	TONE/CTCSS	REV	Enter
	4	5	6	B
[F], [KEY]	—	DTMF keypad LOCK ON	DTMF keypad LOCK OFF	Speaker Select
[KEY]	MHz	MONITOR	Frequency Readout (Beep)	CONT SEL
	7	8	9	C
[F], [KEY]	—	—	—	—
[KEY]	VOL ON/OFF	V^2 / U^2	SQL ON/OFF	MUTE
	*	0	#	D
[F], [KEY]	DOWN	DIM	UP	Cancel [F]
[KEY]	DOWN	LOW	UP	[F]

ADDITIONAL REMOTE FUNCTIONS

In addition to those functions shown in the diagram on page 81 that can be used while in Remote Control mode, some keys on the microphone also have duplicate functions at all times of their equivalent buttons on the Front Panel of the transceiver. Further, the Monitor function can be used from the microphone even though it is not available on the Front Panel {page 83}.

■ Configuring the PF Keys

The Programmable Function (PF) keys are the horizontal row of 4 keys located on the face of the microphone. These keys are identified as follows:

Microphone Key Label	General Key Name	Default Function
PF	PF1	Band Select
MR	PF2	Memory Recall
VFO	PF3	VFO Select
CALL	PF4	Call Channel

If you prefer, other functions can be assigned to the PF keys.

- 1 Press one of the following key combinations depending on which key you want to reassign:
[PF]+ POWER ON, or
Microphone **[MR]+ POWER ON**, or
Microphone **[VFO]+ POWER ON**, or
Microphone **[CALL]+ POWER ON**
 - "PF1", "PF2", "PF3", or "PF4" appears.
- 2 Press the key or key combination on the Front Panel that you want to assign to the microphone PF key pressed in Step 1.
 - The following types of Front Panel key functions can be assigned to a PF key:
[KEY]
[F], [KEY]
[F] (1 s), [KEY]
[F]+[KEY]

- The following Front Panel functions or types of functions cannot be assigned to a PF key:

[F]

[PWR]

Tuning control

[PTT]

[F] (1 s)

[KEY]+ POWER ON

- The Front Panel key will still function normally after "copying" its function to a PF key.
- To restore the default functions shown in the chart on page 82, do a Full Reset {page 50}.

■ Monitor Function

Monitor allows you to override any squelch systems being used so activity on a frequency can be heard. This is handy to quickly listen to a frequency without actually changing the squelch setting or disabling the squelch system.

Press **[F]+ POWER ON** to assign the Monitor function to microphone **[PF]**.

- Reconfigure **[PF]** {page 82} to cancel this function.

To use the Monitor function, press microphone **[PF]** to toggle the function ON or OFF. Scan will not function if Monitor is ON (squelch open).

■ Enter Function

The Enter function is used for entering digits from an MC-45DM microphone.

Press **[F]+[VFO]+ POWER ON** to assign the Enter function to microphone **[PF]**.

- Refer to Keypad Direct Entry.

REMOTE FUNCTIONS USING TH-7

The transceiver can be controlled with the TH-7 (General market transceiver) simply by connecting the cable supplied with the TH-7 between the transceivers. The TH-7 is also useful as a speaker-microphone for the transceiver. See the TH-7 instruction manual for details. The Remote Control status {page 80} does not affect operation of the TH-7.

When using a TH-7 for Remote Control of this transceiver, switch ON the RD output function {page 29}.

Also, the DTMF dialer cannot be used from a TH-7.

KEYPAD DIRECT ENTRY

The Enter function allows you to enter frequency digits, memory channel digits, or Tone number digits directly from the MC-45DM microphone. While using Remote Control, pressing the **[A]** key also places the transceiver into direct entry mode.

■ Frequency Entry

Entering the desired frequency directly via the microphone keypad can be the fastest way of selecting a different frequency especially when a small frequency step has been selected. If the new frequency is hundreds of kHz or more from the current frequency, and you don't have the new frequency stored in any memory channels, direct entry may be the quickest way to select your frequency.

- 1 Press **[BAND SEL]** to select your desired band.
- 2 Press **[VFO]** to select VFO mode.
- 3 Press **[F]+[VFO]+ POWER ON**, then press microphone **[PF]**.
 - Alternatively, press **[F]+[CONT SEL]** to activate Remote Control, then press microphone **[A]**.
 - " - " indicators appear. The transceiver is ready to receive frequency digits from the microphone.

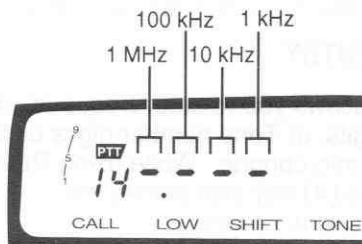

- 4 Press keys **[0]** to **[9]** for the frequency you want.
 - Enter the digits in order from the most significant down to the least significant.
 - Pressing keys other than **[0]** to **[9]** or **[PF]** cancels direct entry and restores VFO mode.
 - For versions with receiver coverage wider than 10 MHz, the 10 MHz digit must be entered. Otherwise, begin entering from the 1 MHz digit.
 - Except for the 1 kHz digit, entering a digit that is outside the allowable range causes the nearest digit within range to be displayed. For the 1 kHz digit, pressing **[0]** to **[4]** selects "0" and pressing **[5]** to **[9]** selects "5".
 - When the current step size is 5 kHz, 10 kHz, 15 kHz, or 20 kHz, enter numeric values down to the 1 kHz digit. Enter either 0 or 5 for the 1 kHz digit.
 - When the current step size is 12.5 kHz or 25 kHz, entering the 10 kHz digit completes frequency setting. The 10 kHz and subsequent digits are set according to which key is pressed for the 10 kHz digit as shown in the chart.

10 kHz Key	Frequency (kHz)	10 kHz Key	Frequency (kHz)
0	00	5	50
1	12.5	6	62.5
2	25	7	75
3	37.5	8	87.5
4	37.5	9	87.5

Note:

- ◆ If any key other than [0] to [9] or [PF] ([A] if using Remote Control) is pressed, or if the next entry is not made within 10 seconds, the previous frequency will be restored.
- ◆ If [PF] ([A] if using Remote Control) is pressed while entering the frequency, the new data is accepted for the digits entered and the previous data remains unchanged for the digits not yet entered.
- ◆ Turning the **Tuning** control, or pressing microphone [UP]/[DWN], while entering the frequency cancels the new numeric data entered, and raises or lowers the previously displayed frequency.

■ Memory Channel or Tone/CTCSS Number Entry

This is similar to Frequency Entry except this function is used when Memory Recall or Tone Select is being used. If you want to choose a memory channel or Tone number quickly without scrolling through many other choices, this is the method to use.

- 1 Press **[BAND SEL]** to select your desired band.
- 2 Press **[F]+[VFO]+ POWER ON**, or if you prefer to use Remote Control, press **[F]+[CONT SEL]** instead.
- 3 Press **[MR]** to select Memory Recall, or **[F] (1 s), [T.SEL]** to select Tone Select.
- 4 Press microphone **[PF]** or if using Remote Control, press microphone **[A]** instead.
 - "--" appears. The transceiver is ready to receive digits from the microphone.



- 5 Enter 2 digits for the memory channel number or Tone number. Enter the Tone number from the chart on page 61; do not enter the Tone frequency.
- For example, enter [0] [2] for memory channel 2 or Tone number 2. Only European versions will accept Tone number 39 for the 1750 Hz tone.
 - Pressing keys other than [0] to [9] cancels direct entry mode and restores the previous mode.

The transceiver automatically switches to the new memory channel or stores the corresponding Tone frequency after entry of the last digit.

CONTINUOUS TONE CODED SQUELCH SYSTEM (CTCSS)

The CTCSS feature is available only when the TSU-8 CTCSS unit is installed {page 110}.

CTCSS functions by using a subaudible tone that is superimposed by a transmitter on a transmitted signal to control a receiver's squelch. When used in combination with the noise squelch, CTCSS provides a simple method to selectively choose which stations will be heard. This transceiver offers a total of 38 standardized CTCSS frequencies plus 1750 Hz on European versions.

Monitoring is less tiring when using CTCSS since you hear only those stations on a particular frequency that are transmitting the Tone that you have selected.

SELECTING CTCSS FREQUENCIES

Refer to the chart of frequencies available and the procedure for selecting the desired frequency on page 61. Direct entry using an MC-45DM microphone is also possible. Refer to page 85.

USING CTCSS

- 1 Press **[BAND SEL]** to select your desired band.
- 2 Repeatedly press **[TONE]** until "CT" appears on the Display. Each press of **[TONE]** changes the Display as below:

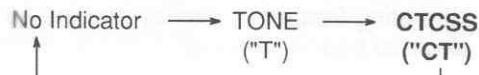

- The CTCSS indicator does not appear if the CTCSS unit is not installed.
- On European versions, a Tone frequency other than 1750 Hz must be selected.

No indicator	Subaudible tone is not transmitted and tone squelch is not functional.
CTCSS	Subaudible tone is transmitted and tone squelch is functional.

Note:

- ◆ When using DTSS or Page with CTCSS, the squelch opens only if the correct CTCSS tone is received and the received DTSS or Page code matches the code stored in your transceiver.
- ◆ If CTCSS and Tone Alert are ON, there is no speaker output except the alarm tone even if a signal is received with the correct CTCSS frequency.

■ Automatic Tone Frequency ID

This function automatically identifies the incoming Tone frequency on a received signal.

- 1 Select the desired band, frequency, and associated data.
- 2 Press **[TONE]** (1 s) to toggle the function ON or OFF.
 - A Tone frequency display replaces the operating frequency display and the 10 kHz decimal begins blinking.
 - When the transceiver receives a signal, it begins scanning in order to identify the Tone frequency. When the frequency is identified, an alarm beeps, and the Display begins blinking.



- 3 Press **[TONE]** to cancel the function. This action replaces the current Tone frequency stored for the selected band by the Tone frequency automatically identified in Step 2.

Note:

- ◆ After identifying a Tone frequency, the transceiver does not scan additional received signals until **[TONE]** is pressed and Step 2 is repeated.
- ◆ On European versions, this function cannot be used if the 1750 Hz tone is selected on the current band.

DUAL TONE SQUELCH SYSTEM (DTSS)

DTSS provides a more refined method than CTCSS to selectively communicate with specific stations. A total of 1000 3-digit DTMF (Dual Tone Multi-Frequency) codes are available to be used as addresses for stations with which you want to communicate. These codes can be changed easily and regularly as required. Due to the quantity of different codes, large networks can be set up that use DTSS for selective calling and receiving. By including group codes in the network plan, sub-groups within the network can be contacted without disturbing others monitoring the same frequency.

If your needs are simpler, DTSS also serves a useful purpose when you only want direct communication with a few close friends on your favorite frequency. A good example of this application is at Hamventions when a particular frequency can be virtually unusable due to overcrowding. If your group switches the DTSS function ON, your squelch only opens when a call is received encoded with the same code that is stored in your transceiver. If no signal is received for more than 2 seconds after DTSS has opened the squelch, the squelch then closes. Anytime you want to monitor all activity on the channel, you simply switch the DTSS function OFF.

STORING DTSS CODES

You can store a DTSS code from 000 to 999 by using the **Tuning** control or the microphone. Be aware that audible DTMF tones from other transceivers near you may be picked up by your MC-45DM or TH-7 microphone element. If so, this could prevent the following function from working correctly.

■ Using the Tuning Control or Microphone [UP]/[DWN]

- 1 Press **[BAND SEL]** to select your desired band.
- 2 Press **[F]**, **[DTSS]** to turn the DTSS function ON.
 - "DT" appears.



3 Press **[F]** (1 s), **[C.SEL]** to activate Code Select.

- The current DTSS code appears with the first digit blinking.



4 Select the first digit for the DTSS code using the **Tuning** control or the microphone **[UP]** or **[DWN]** button.

5 Press **[SHIFT]**.

- The next digit in the code starts blinking.



6 Repeat Steps 4 and 5 for the second and third digits in the code.

7 Press **[MHz]** or **[PTT]**.

- The previous mode is restored.

■ Using the Microphone DTMF Keypad (U.S.A./Canada Versions)

This function can be used on any TM-733 that is equipped with an MC-45DM microphone.

- 1 Press **[BAND SEL]** to select your desired band.
- 2 Press **[F]**, **[DTSS]** to turn the DTSS function ON.
 - "DT" appears.
- 3 Press **[F]** (1 s), **[C.SEL]** to activate Code Select.
 - The current DTSS code appears with the first digit blinking.
- 4 Select the 3 digits for your DTSS code by pressing the correct numeric digits sequentially on the keypad.
 - The previous mode is restored.

Note:

- ◆ If you press buttons other than **[SHIFT]**, microphone **[UP]/[DWN]**, or the microphone numeric keys, or if you do not make a DTSS code entry within 10 seconds, the previous mode is restored. Digits already entered will be stored.
- ◆ DTSS may not function in the following situations:
 - DTSS is switched ON for both the VHF and UHF bands
 - The other station is using a battery saver function.
 - A repeater ID and the DTSS code are received simultaneously.

If difficulty is experienced in these cases, release **[PTT]**, then press **[PTT]** again.

ACTIVATING DTSS

- 1 Press **[BAND SEL]** to select your desired band.
- 2 Press **[F]**, **[DTSS]**.
 - "DT" appears when the DTSS function is ON.
 - Each time this button combination is pressed, the DTSS function switches as follows:

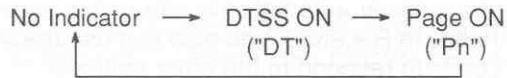

- 3 Press **[PTT]** to transmit your DTSS code.
 - If the Transmit band and Control band are the same, you can press **[PTT]+[SHIFT]** to retransmit the code.

Note:

- ◆ Both DTSS status and a DTSS code can be stored in a memory channel or the Call channel. Further, when recalling either a memory channel or the Call channel with DTSS status ON while using the VFO with Page switched ON, Page is given priority and the DTSS status switches OFF.
- ◆ Each time **[PTT]** is pressed, the DTSS code is transmitted for about 0.5 second. After establishing a contact, you can eliminate this by switching the DTSS function OFF.
- ◆ If DTSS and Tone Alert are ON, there is no speaker output except the alarm tone even if a signal is received with the correct DTSS code.
- ◆ DTSS cannot be used if Remote Control with an MC-45DM is being used.

DTSS AND REPEATERS

Pressing **[PTT]** transmits the DTSS signal after a short delay. This delay helps avoid losing DTSS data when using repeaters with long response times that may miss receiving a portion of the DTSS code. The delay time is 250 ms during simplex operation.

When using a transmit offset or a split frequency, you can select either 350 ms (default) or 550 ms.

- 1 Press **[SHIFT]+ POWER ON**.

- The current Delay Time appears. The default is 350 ms.

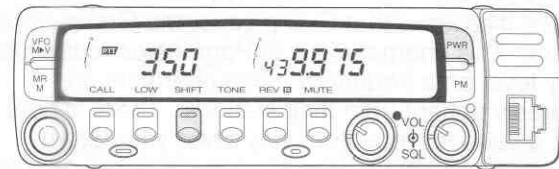

- 2 Turn the **Tuning** control, or press microphone **[UP]/[DWN]**, to toggle the time value between 350 ms and 550 ms.
- 3 Press **[MHz]** or **[PTT]**.

- The previous mode is restored.

Note: DTSS cannot be used with some repeaters. Also, DTSS may not function if a repeater ID and the DTSS code are received simultaneously. Press **[PTT]** again to retransmit the DTSS code, or press **[PTT]+[SHIFT]** if more convenient.

OVERVIEW

Similar to DTSS, Page uses DTMF codes to address a single station or a group of stations. Page is useful when waiting to receive a call from a specific station. A common Group Page code and individual Station codes should be agreed on in advance. You can select codes from the range 000 to 999 inclusive.

Unlike DTSS, Page offers the added benefit of identifying who called you. The calling station's code appears on the target transceiver's display. If called with an individual Station code, that station's code appears; if called with a Group code, the Group code appears. This characteristic of Page helps reduce the activity level on a frequency when operators are temporarily absent from their stations. There is no longer a need for repeated calls when your target station is not listening. On return to his or her operating position, their transceiver display will show your Station code. They will know immediately that you called.

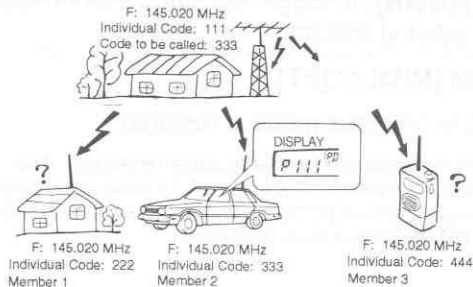

PAGE CODE MEMORY

The transceiver has 7 Page code memories on each band.

A	Stores your Station code.
0	Stores the calling station's code. The transceiver automatically stores this code while in Receive. You also can use the stored code to respond to the other station.
1 to 5	Stores Group codes or Station codes that you want to call.

Group Communication Network Example

Predetermined frequency	145.020 MHz
Your Individual code	111
Member 1	Individual code 222
Member 2	Individual code 333
Member 3	Individual code 444
Group code	789

Your memory

A	111
0	
1	222
2	333
3	444
4	
5	789

Member 1	A 222
	2 789

Member 2	A 333
	3 789

Member 3	A 444
	4 789

STORING PAGE CODES

Audible DTMF tones from other transceivers near you may be picked up by your MC-45DM or TH-7 microphone element. If so, this could prevent the following function from working correctly.

■ Using the Tuning Control or Microphone [UP]/[DWN]

- 1 Press **[BAND SEL]** to select your desired band.
- 2 Press **[F]**, **[DTSS]** twice.
 - Press the key combination once if DTSS is already ON.
 - When Page is ON, "Pn" appears where n is the current Page memory on this band.
- 3 Press **[F] (1 s)**, **[C.SEL]** to activate Code Select.
 - "P zzz" appears where "zzz" is the code stored in the current memory. "— — —" indicates no codes have been stored previously in the selected Page memory.
 - The Page memory digit begins blinking.
- 4 Turn the **Tuning** control, or press microphone **[UP]/[DWN]**, to select Page memory A.

- 5 Press **[SHIFT]**.

- Pressing **[SHIFT]** shifts the transceiver between Page memory select mode and Page code select mode.
- The first digit of the Page code starts blinking.

- 6 Select the first digit for your Station code using the **Tuning** control or the microphone **[UP]** or **[DWN]** button.



- 7 Press **[SHIFT]**.

- The next digit in the code starts blinking.

- 8 Repeat Steps 6 and 7 for the second and third digits in the code.

- 9 Store Station codes or Group Codes of the stations that you plan to call in Page memories 1 to 5 using Steps 4 to 7.

- 10 Press **[MHz]** or **[PTT]**.

- The previous mode is restored.

You can use the Station code or Group code immediately that was stored or selected last.

■ Using the Microphone DTMF Keypad (U.S.A./Canada Versions)

This procedure is similar to the procedure in "Using the **Tuning** Control or Microphone [UP]/[DWN]" {page 93} except the DTMF keypad is used to enter digits since it is quicker. This function can be used on any TM-733 that is equipped with an MC-45DM microphone.

- 1 Press **[BAND SEL]** to select your desired band.
- 2 Press **[F]**, **[DTSS]** twice.
 - Press the key combination once if DTSS is already ON.
 - When Page is ON, "Pn" appears where n is the current Page memory on this band.
- 3 Press **[F] (1 s)**, **[C.SEL]** to activate Code Select.
 - "P zzz" appears where "zzz" is the code stored in the current memory. "--" indicates no codes have been stored previously in the selected Page memory.
 - The Page memory digit begins blinking.
- 4 Press microphone **[A]** to select Page memory A.
 - The first digit of the Page code starts blinking.
- 5 Select the 3 digits for your Station code by pressing the correct numeric digits sequentially on the keypad.

- 6 Store Station codes or Group Codes of the stations that you plan to call in Page memories 1 to 5 in the same manner.

- 7 Press **[MHz]** or **[PTT]**.
 - The previous mode is restored.

You can use the Station code or Group code immediately that was stored or selected last.

CALLING

- 1 Press **[BAND SEL]** to select the desired band, and tune to the prearranged frequency.
- 2 Press **[F]**, **[DTSS]** twice.
 - Press the key combination once if DTSS is already ON.
 - "Pn" appears. "n" is the current Page memory (0 to 5, A).
- 3 Press **[F] (1 s)**, **[C.SEL]** to select Code Select.
 - The Page memory digit starts blinking.



- 4 Turn the **Tuning** control, or press microphone **[UP]/[DOWN]**, to select the Page memory where the desired Station code or Group code has been stored.
 - Alternatively, if your microphone is equipped with a DTMF keypad, the Page memory can be entered by using the keypad. Press the key for the memory you want.
 - If you have not stored the desired Page code in a memory from 1 to 5, select memory 0 and store the Page code at this time.
- 5 To restore the Display, press **[MHz]** or **[PTT]**.
- 6 Press and hold **[PTT]**.
 - The Station code or Group code is transmitted along with your Station code.



Note:

- ◆ When Page is ON, Scan cannot be used.
- ◆ When Page is ON, choosing the VFO, the Call channel, or a memory channel does not affect the Page status. Page remains ON.
- ◆ When Page is switched ON while DTSS is ON, DTSS is switched OFF automatically.

RECEIVING

- 1 Press **[BAND SEL]** to select the desired band, and tune to the prearranged frequency.
- 2 Press **[F]**, **[DTSS]** twice.
 - Press the key combination once if DTSS is already ON.
 - "Pn" appears. "n" is the current Page memory (0 to 5, A).

You are ready to receive a call addressed with your Station code or a Group code. If no signal is received for more than 2 seconds after a Page has opened the squelch, the squelch then closes.

■ Receiving a Call with your Station Code

When a signal is received encoded with your Station code, the squelch opens and you hear an alert tone from the speaker. In addition, the Display shows "P0" and the calling station's code.



Press **[PTT]** while "P" is blinking to respond to the calling party.

■ Receiving a Call with a Group Code

When a signal is received encoded with the correct Group code, the squelch opens and you hear an alert tone from the speaker. In addition, the received Group code and the Page memory (1 to 5) in which that Group code has been stored appear.



Press **[PTT]** while "P" is blinking to respond to the calling party.

Note:

- ◆ "Err" appears on the display if your transceiver fails to receive the Page code correctly.
- ◆ Each time **[PTT]** is pressed, the microphone is inhibited, and the Page code is transmitted. After establishing a contact, you can eliminate this pause by switching the Page function OFF.
- ◆ Page may not function in the following situations:
 - Page is switched ON for both the VHF and UHF bands
 - The other station is using a battery saver function.
 - A repeater ID and the Page code are received simultaneously.

If difficulty is experienced in these cases, release **[PTT]**, then press **[PTT]** again.

- ◆ If Page and Tone Alert are ON, there is no speaker output except the alarm tone even if a signal is received with the correct Page code.

PAGE CODE AND REPEATERS

Pressing **[PTT]** transmits the Page code after a short delay. This delay helps avoid losing Page data when using repeaters with long response times that may miss receiving a portion of the Page code.

The delay time is 250 ms during simplex operation.

When using a transmit offset or a split frequency, you can select either 350 ms (default) or 550 ms.

1 Press **[SHIFT]+ POWER ON**.

- The current Delay Time appears. The default is 350 ms.

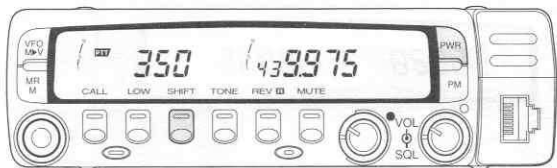

2 Turn the **Tuning** control, or press microphone **[UP]/[DWN]**, to toggle the time value between 350 ms and 550 ms.

3 Press **[MHz]** or **[PTT]**.

- The previous mode is restored.

Note: Page cannot be used with some repeaters.

LOCKING-OUT CODES

This function is useful if you wish to inhibit the transceiver from receiving specific Group Page codes. Page Lock-out does not inhibit the transceiver from receiving stations calling your individual Station code. Although the codes are locked-out from the receiver, the transmitter still transmits a Page on the locked-out channels.

1 Press **[BAND SEL]** to select the desired band.

2 Press **[F]**, **[DTSS]** twice.

- Press the key combination once if DTSS is already ON.

3 Press **[F] (1 s)**, **[C.SEL]** to activate Code Select.

- The Page memory digit begins blinking.

4 Turn the **Tuning** control, or press microphone **[UP]/[DWN]**, to display the Page code you want to lock-out.

5 Press **[MR]**.

- A "star" appears below the Page memory number to indicate the channel has been locked-out.



6 Press **[MHz]** or **[PTT]** to restore the Display.

- The previous mode is restored.

Repeat Steps 3 to 5 to unlock the Page code.

Note: You cannot lock-out Page memory 0 or A.

AUTO PAGE CANCEL

After successfully paging another station, it is useful to turn OFF Page to eliminate sending a Page code each time you transmit. Auto Page Cancel handles this situation automatically when a station you called responds using the correct Page code to open your transceiver's squelch. On your next transmission, your transceiver then switches OFF your transceiver's Page function.

Press **[F]+[DTSS]** to toggle Auto Page Cancel ON or OFF.

- "ON" appears briefly on the lower right corner of the Display when the function is switched ON. The default is OFF.

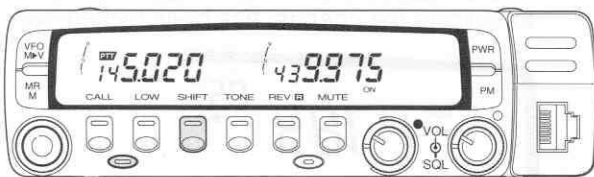

OPEN PAGE

When both this function and Page are ON, any signal opens the squelch; however, if a correct Page code is received, the calling station's code appears on the Display. This feature is beneficial when you want to generally monitor activity on a frequency but you want to be especially sure not to miss a friend's call.

Press **[BAND SEL]+ POWER ON** to toggle Open Page ON or OFF.

- Press **[BAND SEL]** for the band that you want to use since Open Page can be activated on each band independently.

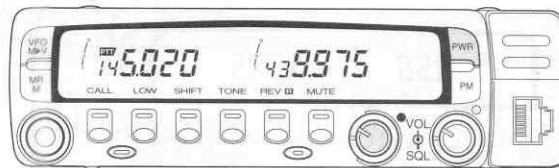

TONE ALERT

Tone Alert provides an audible alarm to indicate when someone is transmitting on the frequency you are monitoring.

Tone Alert is an effective partner with CTCSS, Page, or DTSS. When the correct signaling comes through, your transceiver beeps to alert you of an incoming call from a specific station.

ACTIVATING TONE ALERT

- 1 Press **[BAND SEL]** to select your desired band, and select the prearranged frequency.
- 2 Activate CTCSS, Page, or DTSS if you want to use these together with Tone Alert.
- 3 Press **[F]**, **[T.ALT]**.
 - A "bell" appears. Each time this key combination is pressed, Tone Alert toggles ON and OFF.
 - If Tone Alert is ON, there is no speaker output except the alarm tone when a signal is received. To hear receive audio, assign the Monitor function {page 83} to microphone **[PF]** before switching on Tone Alert.



- 4 When the correct signal is received, the transceiver rings 3 times, the "bell" begins blinking, and the Call Number increments.
 - The Display shows the number of minutes and seconds elapsed after the last signal was received. After 59 minutes 59 seconds pass, the Display changes to 01.00 and continues counting. After 59 hours 59 minutes pass, counting stops. When the next signal is received, the time resets to 00.00 and counting continues. Each time a new signal is received, the time resets to 00.00.
 - The Call Number records the number of calls received to a maximum of 99.
 - The alarm tone can be changed if you prefer {page 100}.
- 5 Exit Tone Alert by pressing **[MHz]** or **[PTT]**.

Note:

- ◆ APO turns OFF the power if no key entry is made for 24 hours even if Tone Alert is ON.
- ◆ For Tone Alert to function correctly with CTCSS, the incoming signal must be present for approximately 1 second.
- ◆ If you find Tone Alert does not work reliably, your receive signal may contain distortion or a high level of ignition noise. One remedy is to install a TSU-8 CTCSS unit and select a Tone of 141.3 Hz or lower frequency to act as a filter.
- ◆ Tone Alert and Scan cannot be used together.

CHANGING THE ALARM TONE

Depending on where your station is installed and the ambient noise at your station location, you may want to change the default alarm signal that sounds when Tone Alert detects an incoming call. You have a choice of 3 alarm signals that may be selected. Beep Tone {page 77} must be ON for this function to work.

- 1 Press **[BAND SEL]** to select your desired band.
- 2 Press **[F]+[SHIFT]+ POWER ON**.
 - The current tone alarm appears. The default is "bel 1".

- 3 Turn the **Tuning** control, or press microphone **[UP]/[DWN]**, to select the alarm tone you prefer.
 - bel 1: 3 telephone-style rings
 - bel 2: 4 high-pitched double tones
 - bel 3: musical tune
- 4 Press **[MHz]** or **[PTT]**.
 - The previous mode is restored.

PACKET OPERATION

One of the most exciting benefits of owning a VHF or UHF transceiver nowadays is being able to use it for Packet radio.

You can use almost any computer to control one of the widely available Terminal Node Controllers (TNC) since the computer primarily serves to input commands and output received text data to its display. Little real computing power is needed, therefore a high-powered processor is not necessary, and even a "dumb" terminal is satisfactory, at least to start. As you become more experienced, you will realize how well your interest in radio meshes with the world of data communications.

Connecting to one of the many stations with gateways to HF or satellite links can give you national and worldwide messaging or conferencing capability with other Amateurs with nothing more than your VHF/UHF transceiver for the communications link. Much reference material is available for getting started in digital communications from any store that handles Amateur Radio equipment. Or, if more convenient, check the radio magazines for mail order bookstores.

1200/9600 bps OPERATION

After connecting the necessary Packet station equipment as explained in "PACKET EQUIPMENT" on page 10, you must match your TNC transmission speed with the transmission speed selected on the transceiver.

Press **[F]+[STEP]** to toggle between 1200 bps and 9600 bps.

- When 9600 bps is selected, "9600" appears at the right edge of the Display. The default is 1200 bps.

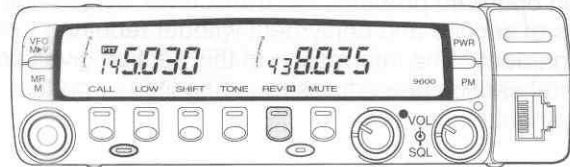

MAINTENANCE

GENERAL INFORMATION

Your transceiver has been factory aligned and tested to specification before shipment. Under normal circumstances, the transceiver will operate in accordance with these operating instructions. All adjustable trimmers, coils and resistors in the transceiver were preset at the factory. They should only be readjusted by a qualified technician who is familiar with this transceiver and has the necessary test equipment. Attempting service or alignment without factory authorization can void the transceiver warranty.

When operated properly, the transceiver will provide years of service and enjoyment without requiring further realignment. The information in this section gives some general service procedures requiring little or no test equipment.

SERVICE

If it is ever necessary to return the equipment to your dealer or service center for repair, pack the transceiver in its original box and packing material. Include a full description of the problems experienced. Include your telephone number along with your name and address in case the service technician needs to call for further explanation while investigating your problem. Don't return accessory items unless you feel they are directly related to the service problem.

You may return your transceiver for service to the authorized **KENWOOD** Dealer from whom you purchased it or any authorized **KENWOOD** service center. A copy of the service report will be returned with the transceiver. Please do not send subassemblies or printed circuit boards. Send the complete transceiver.

Tag all returned items with your name and call sign for identification. Please mention the model and serial number of the transceiver in any communication regarding the problem.

SERVICE NOTE

Dear YL/OM,

If you desire to correspond on a technical or operational problem, please make your note short, complete, and to the point. Help us help you by providing the following:

- 1 Model and serial number of equipment
- 2 Question or problem you are having
- 3 Other equipment in your station pertaining to the problem
- 4 Meter readings
- 5 Other related information

CAUTION: Do not pack the equipment in crushed newspapers for shipment! Extensive damage may result during rough handling or shipping.

Note:

- ◆ Record the date of purchase, serial number and dealer from whom the transceiver was purchased.
- ◆ For your own information, retain a written record of any maintenance performed on the transceiver.
- ◆ When claiming warranty service, please include a photocopy of the bill of sale, or other proof-of-purchase showing the date of sale.

CLEANING

The buttons, controls and case of the transceiver are likely to become soiled after extended use. Remove the controls from the transceiver and clean them with a neutral detergent and warm water. Use a neutral detergent (no strong chemicals) and a damp cloth to clean the case.

TROUBLESHOOTING

The problems described in this table are commonly encountered operational malfunctions. These types of difficulties are usually caused by improper hook-up, accidental incorrect control settings, or operator error due to incomplete programming. These problem symptoms are not caused by circuit failures. Please review this table, and the appropriate section(s) of this Instruction Manual, before assuming your transceiver is defective.

Problem Symptom	Probable Cause	Corrective Action	Page Ref.
The transceiver will not power up after connecting a 13.8 V DC power supply and pressing [PWR]. Nothing appears on the Display.	1 The power cable is connected backwards.	1 Connect the supplied DC Power Cable correctly: Red → (+); Black → (-).	4, 7
	2 One or more of the power cable fuses are open.	2 Look for the cause of the blown fuse/fuses. After inspecting and correcting any problems, install new fuses with the same ratings.	5, 8
	3 The Front Panel is not connected securely to the Main Unit of the transceiver.	3 Lock the Front Panel securely to the Main Unit by using the Release switch on the bottom of the Front Panel.	17
	4 The connectorized cable has not been correctly connected.	4 Connect the connectorized cable correctly.	4, 7

Continued

Note: When 2 frequencies are received in the same band and these frequencies have a relationship per the equation below, an internal heterodyne may be heard. This is not a defect.

$$(UHF \text{ receive frequency on the VHF Band} - 45.05) \times 2 - (\text{Receive frequency on the UHF Band} - 58.525) \times 2 = 45.05$$

Problem Symptom	Probable Cause	Corrective Action	Page Ref.
The Display is too dim.	1 The Display Dimmer needs changing.	1 Press [F] , [DIM] . Turn the Tuning control to select the desired illumination.	78
	2 The supply voltage is too low.	2 The supply voltage requirement is 13.8 V DC \pm 15% (11.7 V to 15.8 V DC). If the input voltage is outside this range, recharge your battery or adjust your regulated power supply.	4, 7
No sound comes from the speaker even though the VOL control is turned clockwise.	1 The squelch is closed.	1 Reset the squelch threshold.	27
	2 DTSS is ON ("DT" is visible); DTSS codes that you are receiving are different from the code set in your transceiver.	2 To monitor activity, press [F] , [DTSS] twice to switch OFF the DTSS function. To contact stations using DTSS, review "DTSS".	89
	3 Page is ON ("P" is visible); Page codes that you are receiving are different from those set in your transceiver.	3 To monitor activity, press [F] , [DTSS] to switch OFF the Page function. To contact stations using Page, review "Page".	92
	4 If the TSU-8 CTCSS option is installed, CTCSS is ON ("CT" is visible); CTCSS tones that you are receiving are different from the tone frequency set in your transceiver.	4 To monitor activity, press [TONE] to turn OFF the CTCSS function. To contact stations, review "CTCSS".	87
	5 Tone Alert is ON ("Bell" is visible).	5 Press [F] , [T.ALT] to switch OFF the Tone Alert function.	99

Continued

Problem Symptom	Probable Cause	Corrective Action	Page Ref.
Most buttons/keys and the Tuning control do not function.	One of the Lock functions is ON.	Unlock all of the Lock functions.	75
The frequency cannot be selected by turning the Tuning control or by pressing microphone [UP]/[DWN] .	Memory Recall or the Call channel is selected.	Press [VFO] .	32
Memory channels cannot be selected by turning the Tuning control or by pressing microphone [UP]/[DWN] when using Memory Recall.	1 No data has been saved in any memory channels, or entered data was erased by a Full Reset.	1 Store data in some memory channels.	42
	2 The Call channel is selected.	2 Press [MR] to switch to Memory Recall.	44
You cannot transmit even though you press [PTT] .	1 The microphone plug is not inserted completely in the Front Panel connector.	1 Switch OFF the power, ensure the microphone connector on the Front Panel has no foreign objects in it, then insert the microphone plug until the locking tab clicks in place.	17
	2 You have selected a transmit offset that places the transmit frequency outside the transmit band range.	2 Press [SHIFT] one or two times so neither "+" nor "-" are visible.	58
Switching the power ON restores the default VFO frequency; previously stored data is gone.	The backup lithium battery voltage is too low.	Switch ON the transceiver. One hour of recharging minimum is required. Full recharging requires 10 hours.	—

Continued

Problem Symptom	Probable Cause	Corrective Action	Page Ref.
Memory transfer copies data from a memory channel to the VFO correctly, but turning the Tuning control causes the frequency to jump to a frequency within the Programmable VFO range.	The frequency is jumping to be within the Programmable VFO limits.	Do a Partial Reset.	49
The VFO frequency range is very narrow.	The Programmable VFO limits are set for a narrow frequency range.	Change the Programmable VFO limits.	33
Band Scan only scans a narrow range of frequencies; the entire band cannot be scanned.	You are actually using Programmable Band Scan because you have selected a VFO frequency within the limits for Programmable Band Scan.	Select a frequency that is outside the limits set for Programmable Band Scan, then press [VFO] (1 s) .	69
The transceiver does not respond correctly after you press button combinations per instructions in this manual.	Buttons are not being pressed in the correct manner.	Review "CONVENTIONS FOLLOWED IN THIS MANUAL". Different functions are selected depending on how long a button is held down or whether a button is released before the next button is pressed, etc.	2
Packet operation results in no connects with other stations.	<ol style="list-style-type: none"> 1 Your frequency differs from the target station's frequency. 2 The modulation level from the TNC is incorrect. 3 There is multi-path distortion. 	<ol style="list-style-type: none"> 1 Adjust your frequency using the Tuning control. 2 Adjust the TNC modulation level according to the TNC instruction manual. 3 Reorient the antenna. The strongest signal does not always provide the best operation on packet. 	101 — —

OPTIONAL ACCESSORIES

MC-45
Multifunction
Microphone



MC-45DM
Multifunction
Microphone
with DTMF keys



PS-33
Regulated DC
Power Supply



PG-2N
DC Power Cable

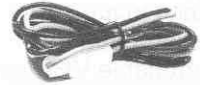

PG-3G
DC Line Noise Filter
(High Capacitance Type)



PG-3B
DC Line Noise Filter

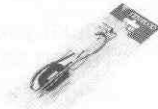

TSU-8
CTCSS Unit



MB-12
Mobile Mounting
Bracket



MB-201
Mobile Mounting
Bracket

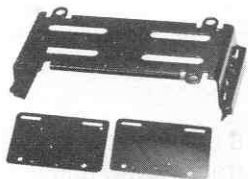

DFK-3B
Detachable Front
Panel Cable (3 m)

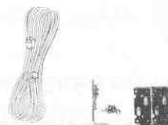

DFK-4B
Detachable Front
Panel Kit (4 m)

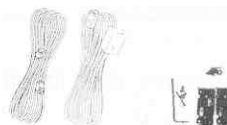

DFK-7B
Detachable Front
Panel Kit (7 m)

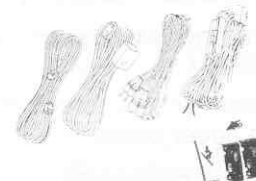

SP-41
Mobile Speaker



SP-50B
Communications
Speaker



PG-5A
Data Cable



MJ-88
Microphone Plug
Adapter



MJ-89
Modular Plug
Microphone
Switch



TH-7
144/430 MHz FM
Dual Bander
(General only)



MA-700
Dual Band Mobile
Antenna with
Duplexer
(U.S.A./ Canada
only)



MC-80
Desktop
Microphone
(MJ-88 required)



MC-55
Mobile
Microphone
(MJ-88 required)

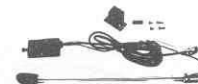

INSTALLING OPTIONS

OPENING THE TRANSCEIVER CASE

CAUTION: Always switch OFF the power and unplug the DC power cable first.

Remove the 4 screws from the upper cover, then lift off the upper cover.

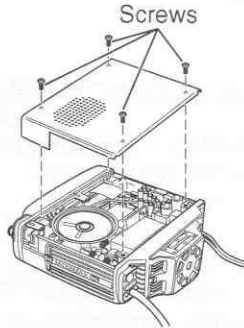

Note: When removing the case, the speaker may come out of the transceiver with the case. If this happens, replace the speaker carefully taking extra care not to contact any metallic parts with the speaker terminals.

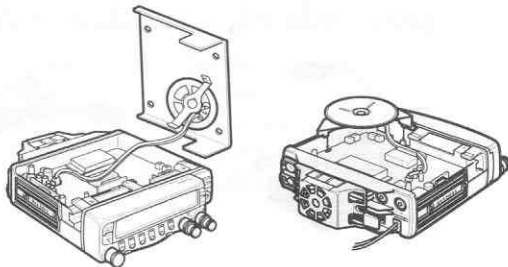

INSTALLING THE TSU-8 CTCSS UNIT

CAUTION: Always switch OFF the power and unplug the DC power cable first.

- 1 Open the transceiver.
- 2 Hold the plastic tab on the TSU-8 unit with the large IC facing toward the front of the transceiver, and insert the connector on the TSU-8 unit into the 8-pin connector as shown.

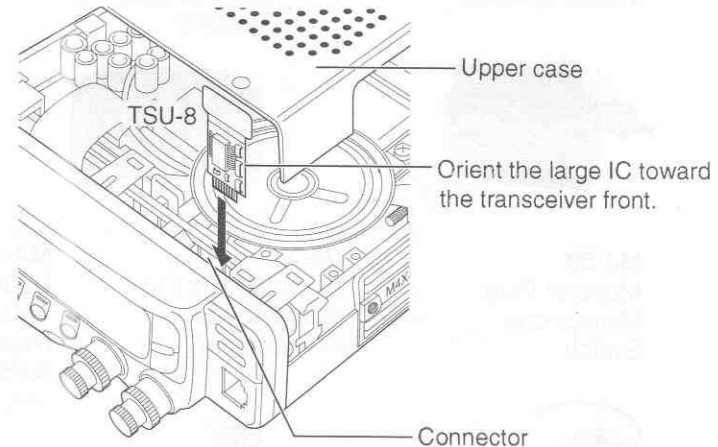

- 3 Replace the upper cover and screws.

REMOVING THE DATA CONNECTOR COVER

CAUTION: Always switch OFF the power and unplug the DC power cable first.

- 1 Slide the spring-loaded Release switch on the bottom of the Front Panel to unlock the Front Panel from the Main Unit.

Hold the Front Panel to prevent the panel from falling when it is released.

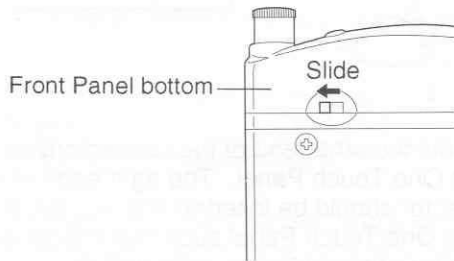

- 2 Pull the Front Panel slightly to the left as you lift it away from the Main Unit.

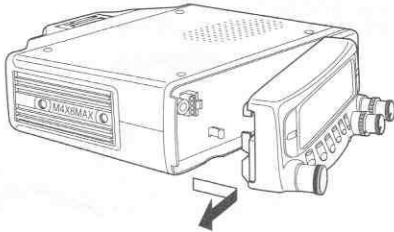

- 3 Insert a small, flat-bladed screwdriver into the slot as shown in the diagram.

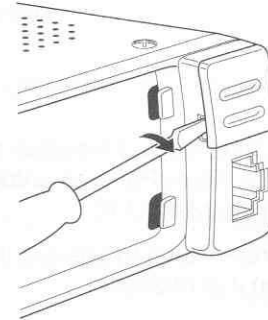

- 4 Pry gently outward with the screwdriver as you pull the cover off with your fingers.

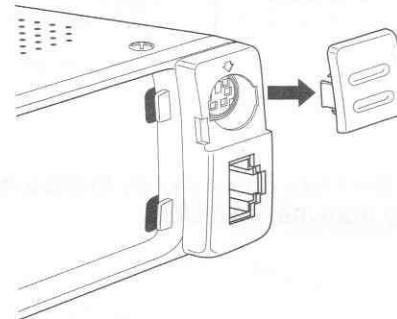

- 5 Re-install the Front Panel by positioning the right rear edge of the panel first, then pressing the left front side of the panel firmly against the Main Unit. When the Release switch clicks, the Front Panel is secured. Store the cover in a safe place.

DETACHABLE FRONT PANEL KITS (DFK-3B, DFK-4B, DFK-7B)

■ Installation

CAUTION: Always switch OFF the power and unplug the DC power cable first.

- 1 Slide the spring-loaded Release switch on the bottom of the Front Panel to unlock the Front Panel from the Main Unit.

Hold the Front Panel to prevent the panel from falling when it is released.

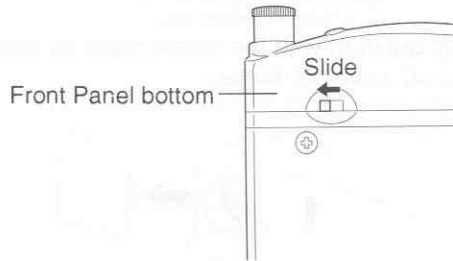

- 2 Pull the Front Panel slightly to the left as you lift it away from the Main Unit.

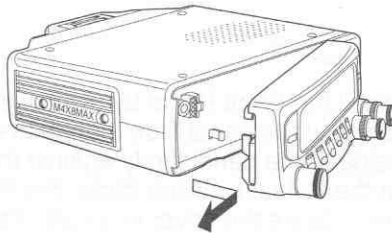

- 3 Hang the connector on the connectorized cable from the Front Panel Kit on the pawl on the front of the Main Unit. Secure the connector using the supplied screw.

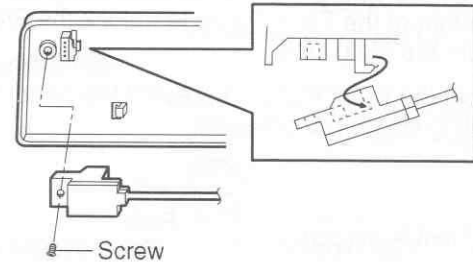

- 4 Connect the other end of the connectorized cable to the One Touch Panel. The right edge of the connector should be inserted first into the space on the One Touch Panel such that the cut-away corners on the connector mate with the positioning tabs protruding into the space. Next, press the left side of the connector into position and secure the connector using the supplied bracket and screw.

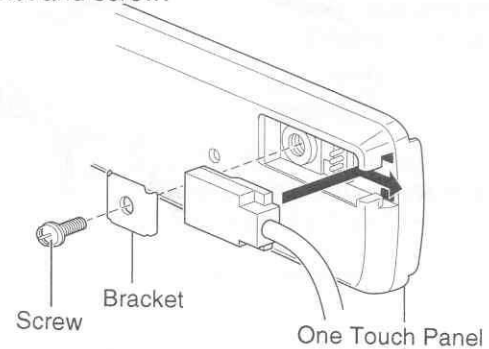

- 5 Install the Front Panel onto the One Touch Panel by positioning the right rear edge of the panel first, then pressing the left front side of the panel firmly against the One Touch Panel. When the Release switch clicks, the Front Panel is secured.

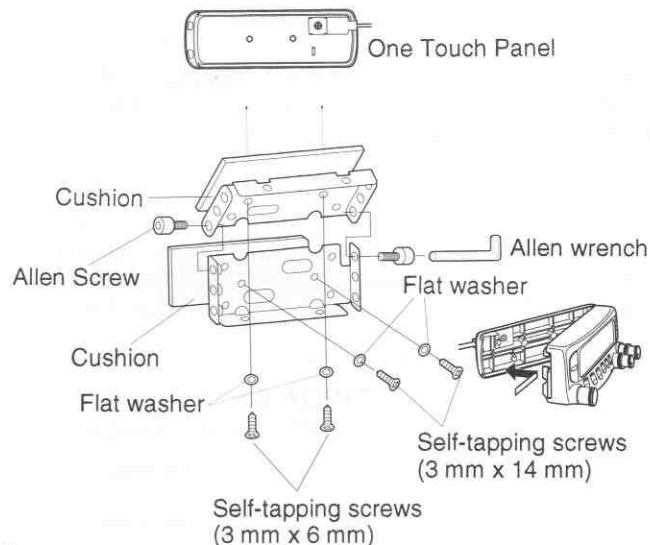

Note:

- ◆ Consider the safety of driver and passengers when deciding where to mount your mobile. Tighten all screws firmly.
- ◆ To install the One Touch Panel in your vehicle, position the mounting bracket using a cushion under the bracket to protect the vehicle. Secure the bracket using the two self-tapping screws as shown. Adjust the angle of the One Touch Panel before firmly tightening the two Allen screws.

■ **Installation Examples**

DFK-3B Connections

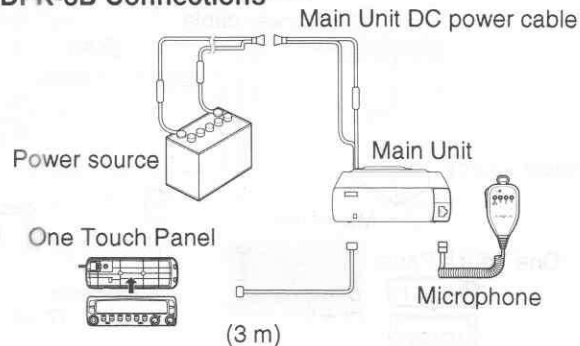

DFK-4B Connections

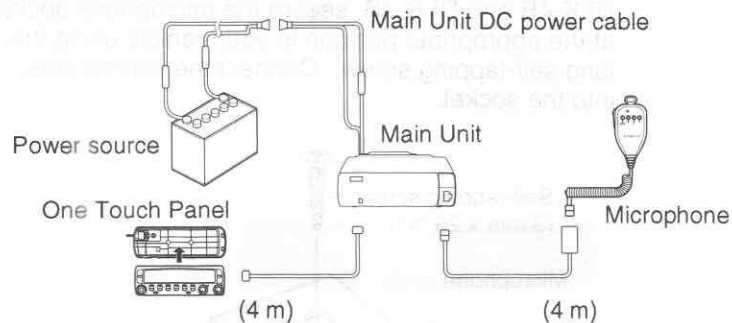

DFK-7B Connections

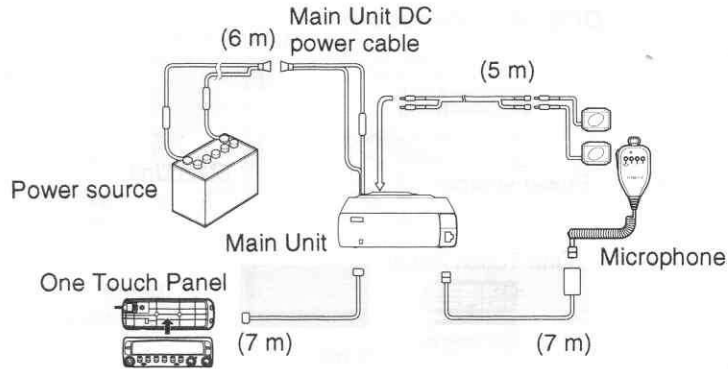

To install the microphone cable included with DFK-4B and DFK-7B, secure the microphone socket at the appropriate position in your vehicle using the long self-tapping screw. Connect the microphone into the socket.

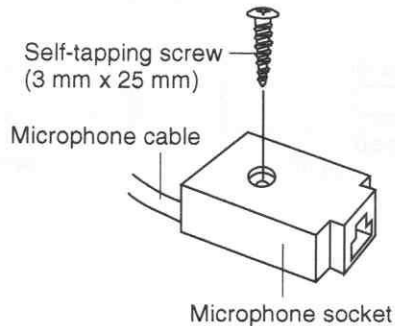

SPECIFICATIONS

Specifications are subject to change without notice due to developments in technology.

General

		144 MHz Band	430/440 MHz Band
Frequency range	U.S.A./Canada	144~148 MHz	438~450 MHz
	General	144~148 MHz	430~440 MHz
	TM-733E	144~146 MHz	430~440 MHz
Mode		F3E (FM)	
Antenna impedance		50 Ω	
Usable temperature range		-20°C ~ +60°C (-4°F ~ +140°F)	
Power supply		13.8 V DC \pm 15% (11.7~15.8 V)	
Grounding method		Negative ground	
Current	Transmit (max.)	11.5 A or less	10.0 A or less
	Receive (no signal)	1.2 A or less	
Frequency stability		Within \pm 10 ppm	
Dimensions (W x H x D projections included)		141 x 42 x 165 mm / 5.55" x 1.65" x 6.50"	
Weight		1.1 kg / 2.4 lb	

Transmitter

		144 MHz Band	430/440 MHz Band
Power output	High	50 W	35 W
	Mid	10 W	
	Low	Approx. 5 W	
Modulation		Reactance	
Spurious emissions		-60 dB or less	
Maximum frequency deviation		±5 kHz	
Audio distortion (at 60% modulation)		3% or less	
Microphone impedance		600 Ω	

Receive

		144 MHz Band	430/440 MHz Band
Circuitry		Double conversion superheterodyne	
Intermediate frequency (1st/2nd)		45.05 MHz/ 455 kHz	58.525 MHz/ 455 kHz
Sensitivity (12 dB SINAD)	V or U band	0.16 μV or less	
	V ² or U ² band	0.25 μV or less	
Selectivity (-6 dB)		12 kHz or more	
Selectivity (-60 dB)		28 kHz or less	
Squelch sensitivity		0.1 μV or less	
Audio output (8 ohms, 5% distortion)		2 W or higher	
Audio output impedance		8 Ω	

Note: Receiver specifications apply only when using the V or U band. They do not apply to the V² or U² band.

This file has been downloaded from:

www.UsersManualGuide.com

User Manual and User Guide for many equipments like mobile phones, photo cameras, monther board, monitors, software, tv, dvd, and othes..

Manual users, user manuals, user guide manual, owners manual, instruction manual, manual owner, manual owner's, manual guide, manual operation, operating manual, user's manual, operating instructions, manual operators, manual operator, manual product, documentation manual, user maintenance, brochure, user reference, pdf manual