Twin Band (2M/70cm) Remote Control Transceiver

DR-599T/E

Advanced Edition OPERATOR'S MANUAL

ALINCO ELECTRONICS INC.

438 Amapola Avenue, Unit 130, Torrance, CA 90501, U.S.A.

Phone: (310) 618-8616

1-1-1 Mishimae, Takatsuki city, Osaka 569, Japan

TABLE OF CONTENTS

INTRODUCTION	pg. 2
ACCESSORIES	pg. 2
INSTALLATION	pg. 2
SPECIFICATIONS	pg. 3
OPTIONS	pg. 5
OPERATIONS	pg. 6
CONTROLS AND FUNCTIONS	pg. 6
QUICK TOUR	pg. 12
RECEIVE	pg. 16
TRANSMIT	pg. 17
PROGRAMING FUNCTIONS AND FEATURES	pg. 17
REPEATER OPERATIONS	pg. 17
CHANNEL STEP	pg. 18
FREQUENCY SELECTION	pg. 18
PL TONE SELECTION	pg. 18
SHIFT/REPEATER OFF SET	pg. 18
MEMORY OPERATION AND PROGRAMING	pg. 19
MEMORY RECALL	pg. 19
MEMORY WRITE	pg. 19
ARM MEMORY RECALL	pg. 20
ARM MEMORY WRITE	pg. 20
CALL MEMORY RECALL	pg. 21
CALL MEMORY WRITE	pg. 21
SCAN	pg. 21
PRIORITY FUNCTION	pg. 22
AUTO PATCH OPERATION	pg. 23
DETACHABLE CONTROL	pg. 24
REMOTE CONTROL	pg. 25
CROSS BAND REPEATER	pg. 26
DSQ (DTMF SQUELCH)	pg. 27
ADDITIONAL FUNCTIONS AND OPERATIONS	pg. 29

INTRODUCTION

Thank you for purchasing the **ALINCO** DR-599T/E ("T" designates American model, "E" designates European model). **ALINCO** radios and other products are ranked as some of the finest in the world. Your DR-599T/E has been manufactured and tested carefully at the factory and will give you satisfactory operation for many years.

ACCESSORIES

Carefully unpack your transceiver and you will find the standard accessories included.

Standard Accessories

1. Hand Microphone (Condenser Type), with 16 button DTMF Touch Tone Pad. (DR-599T model only).
2. Mobile Mounting Bracket.
3. Installation Hardware.
4. DC Power Cord.

Optional accessories are available, as listed below, at your dealer. **ALINCO** strongly recommends that you purchase appropriate accessories to get full features and performance from your radio.

Optional Accessories

1. EJ-7U Tone Squelch Unit. This unit is necessary to operate the tone squelch feature (CTCSS de-coding).
2. EJ-8U DTMF Unit. This unit is necessary for the DSQ function, Auto Dialer, and remote control from an external transceiver.

INSTALLATION

How to install mobile antenna:

Connect the antenna for VHF to the VHF terminal and that for the UHF to the UHF terminal.

When using a single whip dual band antenna, an external duplexer is required.

50 Ohm coaxial cable is required for all antenna installations. Mobile antennas require an appropriate mounting base for proper installation and operation. Please refer to the antenna manufacturer's manual for the proper installation and mounting information.

Antenna accessories (or others not listed in the ACCESSORIES section above) are NOT available from **ALINCO**.

SPECIFICATIONS

(For Ham Bands ONLY. No guarantee or warranty, either specific or implied, will apply to any function or specification outside of the Ham Bands.)

■ General

Frequency coverage:	DR-599T (US Version) VHF Band 144.000 — 147.995 MHz (TX) 135.000 — 173.995 MHz (RX) approx. UHF Band 440.000 — 449.995 MHz (TX) 410.000 — 469.995 MHz (RX) approx. DR-599E (European Version) VHF Band 144.000 — 145.9875 MHz (TX & RX) UHF Band 430.000 — 439.9875 MHz (TX & RX)
Frequency Resolution:	5, 10, 12.5, 15, 20 & 25 kHz steps
Antenna Impedance:	50 Ohms unbalanced
Power Supply Requirements:	13.8 Volts D.C. (Std. Auto Battery)
Current Drain at 13.8V:	Receiving: Squelched does not exceed 800 mA Transmitting: VHF High 45W @ 9.5A (approx.) Middle 10W @ 4.5A (approx.) Low 5W @ 3.5A (approx.) UHF High 35W @ 10A (approx.) Middle 8W @ 5.0A (approx.) Low 4W @ 4.0A (approx.)
Dimensions:	150mm(W) × 50mm(H) × 178mm(D)
Weight:	Approx. 1.5 kgs

■ TRANSMITTER

Output Power:	VHF High 45W (approx.) Middle 10W (approx.) Low 5W (approx.) UHF High 35W (approx.) Middle 8W (approx.) Low 4W (approx.)
Emission Mode:	F3E (FM)
Modulation System:	Variable Reactance FM
Max. Frequency Deviation:	+ 5 kHz
Spurious Emission:	- 60 dB (or under)
Microphone:	Electret Condenser Microphone
Operating Mode:	Simplex
Duplex:	5 kHz and 12.5 kHz steps between 0 & 10.995 MHz from receiver frequency.
DTMF Encoder:	Built-in (DR-599T only)

■ Receiver

Receiver System:	Superheterodyne, Dual Conversion
Modulation Acceptance:	F3E (FM)
Intermediate Frequency:	1st 30.825 MHz and 455 kHz at VHF 1st 30.825 MHz and 455 kHz at UHF
Sensitivity:	12 dB Sinad — 16 dB μ (0.1 μ V approx.)
Selectivity:	+ 6 kHz or under at - 6 dB + 12 kHz or under at - 60 dB
Audio Power Output:	Approx. 2.5W
Speaker Impedance:	8 Ohms

** All specifications are for reference purpose ONLY. Individual radios may experience different performance and/or specification levels. All specifications are approximations and may vary (+ or -) 10% or more.

Tone Squelch Unit (EJ-7U)

This unit is necessary to operate the Tone Squelch Function (CTCSS Decode). Two circuits for VHF and UHF are incorporated into one unit. Thus, it is possible to specify and operate independently for VHF and UHF.

Installation:

- 1 Remove screws from the bottom cover of main unit and from the sides.

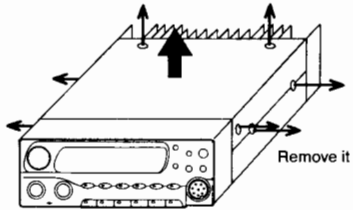

- 2 Remove the bottom cover and you'll find two connectors at the lower left corner (control panel facing forward).

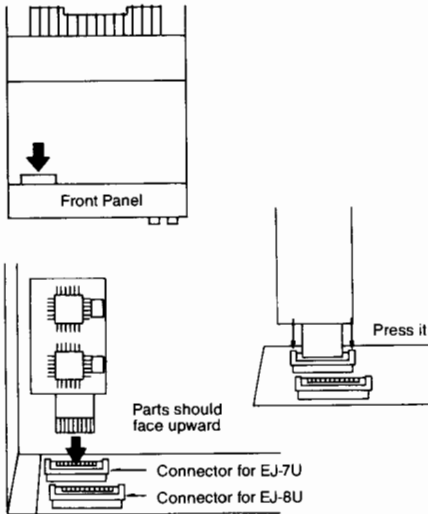

- 3 Open the locking collars on the connector and install the Tone Squelch Unit in the lower connector. The side with IC's should face upward (toward you). After installation, close the locking collars around the connector to secure the EJ-7U board. Attach the foam tape to secure the circuit board.
- 4 Re-Assemble radio, and re-set micro-processor (Turn on the DR-599T/E while pushing FUNC key). LCD display shows 145.000 VHF and 445.000 UHF.

DTMF Unit (EJ-8U)

This unit is required for the following DR-599T/E functions: DSQ (DTMF Squelch Control), Auto Dialer, and Remote Control (from a remote transceiver).

Installation:

- 1 Follow steps 1 & 2 of EJ-7U installation instructions (above).
- 2 Open the collars on the connector and install the DTMF Unit in the upper connector. The side with IC's should face downward (away from you). After installation, close the locking collars around the connector to secure the EJ-8U board. Attach the foam tape to secure the circuit board.

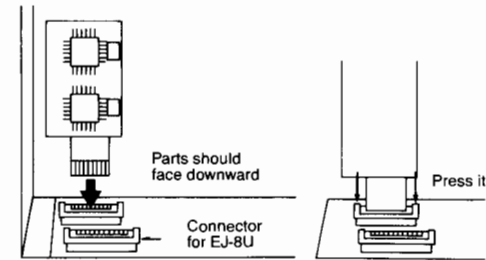

- 3 Re-Assemble radio, and re-set micro-processor (Turn on the DR-599T/E while pushing FUNC key). LCD display shows 145.000 VHF and 445.000 UHF.

CONTROLS AND FUNCTIONS

■ Front Panel

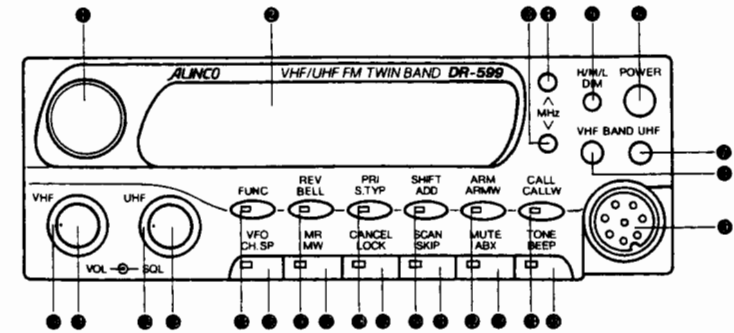

1 MAIN TUNING DIAL

The main tuning dial/knob may be rotated in either direction to select transmit/receive frequencies, frequency steps, sub-audible tones, and transmit frequency offsets.

2 LCD PANEL

Highly visible under all lighting conditions, the LCD panel displays functional information during transceiver operations. Refer to appropriate section of this manual for details.

3 MHz DOWN KEY

Frequency of selected band is decreased one MHz with each touch of this key. When the key is pressed and held, the frequency decreases rapidly in one MHz increments. This key is also used to change memory channels and offset frequencies downward in one MHz steps.

4 MHz UP KEY

Used the same as the MHz DOWN key, except frequency, memory channel, or offset transmit frequency changes upward in one MHz steps.

5 H/M/L (DIM) KEY

A. Power Setting
Pressing the H/M/L key selects desired transmitter output power. Power level is indicated by MID and LOW symbols on the LCD panel. When neither MID nor LOW appear on the LCD panel, the power level is HIGH. LOW power is 5 watts for

VHF, 4 watts for UHF; MID power is 10 watts for VHF, 8 watts for UHF; HIGH power is 45 watts for VHF, and 35 watts for UHF.

B. Illumination Setting (DIM)
used in combination with the FUNC key increases or decreases the LCD panel illumination intensity.

6 POWER SWITCH

Main power ON/OFF switch. Push in to turn ON, push again to turn OFF.
(Note: If unit power switch is in OFF position, and current is applied from outside power source LCD will flash once. This is a normal function, as the unit is running a system check.)

7 UHF BAND SWITCH

Press this key to select the UHF Band as the main (transmitting) band. The "U" symbol will appear on the UHF Band side of the display.

8 VHF BAND SWITCH

Press this key to select the VHF Band as the main (transmitting) band. The "V" symbol will appear on the VHF Band side of the display.

9 MICROPHONE CONNECTOR

Connect the supplied microphone to this connector.

10 VHF SQUELCH CONTROL

Adjusts VHF squelch. Start by turning the knob fully counter-clockwise, then rotate the knob back (in a clockwise direction) until background noise just disappears.

11 VHF VOLUME CONTROL

Adjusts VHF audio level. Rotate clockwise to increase volume.

12 UHF SQUELCH CONTROL

Same procedure as VHF Squelch Control.

12 UHF VOLUME CONTROL

Same procedure as VHF Volume Control.

13 FUNC [Function] KEY

Controls access to secondary functions (printed in green on the control keys). FUNC is displayed on the LCD panel when selected. In this manual all secondary functions are shown in parentheses). It is necessary to push the FUNC key to access secondary functions.

15 VFO (CH.SP) KEY

A. VFO (Variable Frequency Oscillator).
Selects (or returns to) VFO from other operation modes.

B. Channel Step Selection (CH.SP) used to select desired incremental changes of receive/transmit frequencies, in steps of 5 kHz, 10 kHz, 12.5 kHz, 15 kHz, 20 kHz, or 25 kHz. After Channel Step is set, receive/transmit frequency will increase (or decrease) by the value selected when you turn the MAIN TUNING DIAL.

15 REV (BELL) KEY

A. Reverse
Used during duplex operations. — REV reverses the transmitting frequency and the receiving frequency. This feature is used for listening on the input frequency of a repeater, to determine if simplex communication is possible.

B. Bell
This activates a tone whenever squelch is opened, alerting the operator to a signal on the main band. The bell will be activated even with the audio volume all the way down.

17 MR (MW) KEY

A. Memory Recall
Used to access the Memory mode, and display Memory Channels.

B. Memory Write
Used to write (store) frequencies and features into a Memory Channel.

18 PRI (S.TYP) KEY

A. Priority
Selects the priority mode, allowing one important channel to be scanned periodically during various scanning modes.

B. Scan Type
Used to select the desired Scan Type:
Busy Scan: Stop at busy frequency and hold until clear.

Open Scan: Stop at open frequency and hold for several seconds.

Time Scan: Stop at busy frequency and hold for several seconds.

Program Scan: Start and Stop at selected lower and upper frequencies.

Priority Scan: As described above.

19 CANCEL (LOCK) KEY

A. Cancel
Voids a mistaken entry and returns the unit to the previously set frequency and function.

B. Lock
Disables function and control key.

20 SHIFT (ADD) KEY

A. Shift, or offset
Selects + or – repeater shift, or simplex transmission.

B. Additional Scan
Used in connection with various scan modes.

21 SCAN (SKIP) KEY

A. Scan
Starts and stops the scan mode.

B. Skip
Used to skip selected memory channels during a memory scan.

ARM (ARMW) KEY

A. Additional Repeater Memory
10 additional memory channels, specifically designed for storing repeater frequencies, shifts, offsets, etc.

B. Additional Repeater Memory Write
Used to write repeater information to the ARM bank of memory channels.

MUTE (ABX) KEY

A. Mute
Used to mute the audio on either band.

B. Automatic Band Exchange
Switches the transmitting band between VHF and UHF, as a signal is received on either band. Very useful when monitoring and transmitting on both bands.

CALL (CALLW) KEY

A. Call
Used to access a pre-programmed frequency with the push of one key.

B. Call Write
Used to write your Call Frequency to the Call Channel.

TONE (BEEP) KEY

A. CTCSS (Sub-Audible) Tone
Used to activate (encode or decode) and select one of 38 sub-audible tones factory programmed in the radio.

B. Beep
Enables or disables a beep, indicating that a key has been pressed, or that an automatic function has occurred.

■ LCD DISPLAY

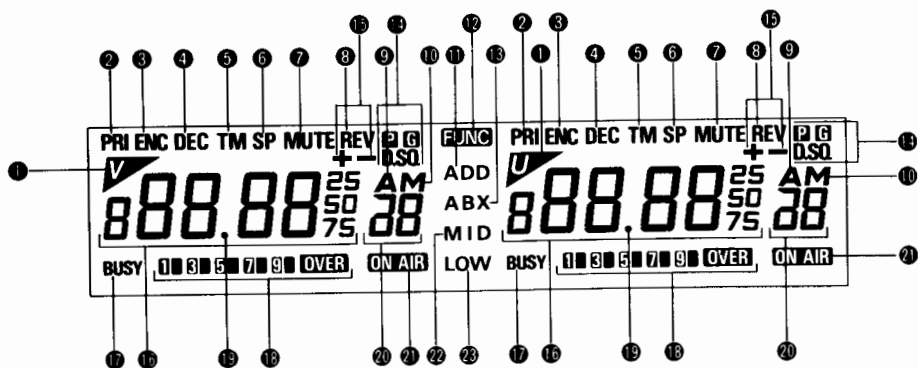

1 MAIN BAND

Indicates Main (Transmitting) Band.

2 PRI

Priority function On.

3 ENC

CTCSS tone encoded. The tone will be transmitted with the main carrier.

4 DEC

CTCSS tone decoded. For selective listening. Incoming CTCSS tone will be received and decoded.

5 TM

Time Scan Function On. Scan stops on first busy frequency and resumes after 5 seconds, even if signal is still present.

6 SP

Open Channel Scan On. Scan stops at first open frequency and will remain there until signal is received.

7 MUTE

Audio is muted on selected band.

8 REV

Reverse function selected.

9 A

Additional Repeater Memory function activated.

10 M

Memory mode selected.

11 ADD

Additional Programed Scan active.

12 FUNC

Function is On. Secondary green function keys may be activated.

13 ABX

Automatic Band Exchange function enabled.

14 DSQ

DTMF Squelch function (DTMF decode) On.

15 + -

Indicates up or down transmitter offset.

16 FREQUENCY

Displays selected transmit/receive frequencies, channel step, and sub-audible encoded tone frequencies.

17 BUSY

Squelch open, signal being received.

18 S/RF METER

Indicates relative received signal strength or transmitter RF output level.

19 DECIMAL POINT

Indicates: MHz for transmit/receive and offset frequencies.

kHz for channel step.

Hz for encoded CTCSS tone frequency.

Note: In the memory mode, the decimal point will flash on and off.

If Skip Channels are programmed, the decimal point will disappear.

20 MEMORY CHANNEL

Indicates selected memory channels.

21 ON AIR

Indicates transmitting.

22 MID

Middle transmitter output power level selected: 10W/VHF and 8W/UHF.

23 LOW

Low transmitter output power selected: 5W/VHF and 4W/UHF.

■ REAR PANEL

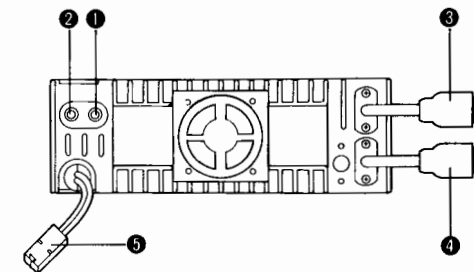

1 VHF 8 Ohm speaker jack.

2 UHF 8 Ohm speaker jack.

3 VHF 50 Ohm antenna connector, marked VHF on connector barrel.

4 UHF 50 Ohm antenna connector, marked UHF on connector barrel.

5 13.8 Volts DC power input connector. Connect supplied DC power cable to this connector. CAUTION: Be sure voltage polarity is correct before connecting power cable. Supplied power cable is polarity coded. RED is positive, BLACK is negative.

MICROPHONE

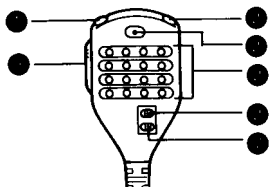

1 & 2 UP/DOWN Switches

Used to step VFO and sub-audible tone frequencies or memory channels up or down. Frequencies will change continuously when switch is pressed and held.

3 PTT Switch

Unit transmits when Push To Talk switch is pressed.

4 MIC

Speak into microphone from approximately 5 inches.

5 16 TONE DTMF PAD (DR-599T Standard/DR-599E Optional)

Each numerical or letter key activates one DTMF tone. Microphone emits a low level verification tone to indicate successful key activation. Transmit DTMF tones by switching the "Remote/DTMF" key to the DTMF position, press and hold the PTT and enter the DTMF tones desired from the Touch Tone Pad on the Mic.

6 LOCK

Disables all microphone functions except PTT.

7 REMOTE/DTMF (DR-599T Standard/DR-599E Optional)

"Remote" position permits mic touch-tone pad input of 16 functions to main unit. "DTMF" position selects DTMF key pad.

QUICK TOUR

QUICK TOUR provides a brief summary of the Operation and Programming of the DR-599T/E

RECEIVE

Power On

- Attach to DC (13.8V) Power Supply, and push POWER button.

VFO Frequency

- Select the desired band (VHF/UHF) with the "VHF/UHF" key.
- Select MHz with the MHz Up/Down key.
- Select kHz with the Main Tuning Dial (5 kHz step).
- Or, you can easily enter frequency directly from the 16key Mic Pad. You must enter all 6 digits, even if the last one is a "0".

TRANSMIT

Simplex

- Select VFO frequency, and push PTT key on Mic to transmit.

Repeater

- Select VFO frequency.
- To select Offset, push "SHIFT" key (once for "–", twice for "+").
- You can adjust the Offset step by turning the main tuning dial after pushing the "SHIFT" key one time.
- Push PTT to return to VFO.

CTCSS Tone

- Push "TONE" key once, Encode is activated. You can choose proper CTCSS Tone by turning the main tuning dial. Push PTT to return to VFO.
- (Pushing the "TONE" key twice will activate Decode if the optional EJ-7U is installed).

PROGRAMMING

Memory Recall

- From the VFO mode, press "MR" key.
- You can scroll the memory channels with the MHz Up/Down key, or enter C08 (Up) C09 (Down) on the Mic.
- (The Up/Down buttons on the Mic also scroll the memory channels.)

Memory Write

- Set Frequency, Offset, CTCSS Tone, etc.
- Push "FUNC" key and turn main tuning dial to select desired memory channel.
- Push (MW) key to write settings to selected memory channel.

Memory ARM Recall

- Press "ARM" key, an "A" will appear, indicating entry to ARM Memory Channels.
- You can scroll ARM with the Up/Down buttons on the Mic.

Memory ARM Write

- Set Frequency, Offset, CTCSS Tone, etc.
- Push "FUNC" key and turn main tuning dial to the "A" memory channel.
- Push (ARMW) key to write setting to first open ARM memory channel.

Memory CALL

- One touch of the "CALL" key will give you immediate access to the CALL channel.

Memory CALL Write

- Set Frequency, Offset, CTCSS Tone, etc.
- Press "FUNC" key and then (CALLW) key to write settings to CALL channel.

Scanning

- From VFO or Memory or ARM mode, push "SCAN" key to start scanning. If no type of scan is chosen, unit will default to "Busy" scan mode, stopping at first busy frequency and holding until clear.
- If you stop on an unwanted busy frequency, you can continue by turning the Main Tuning Dial in the desired direction.
- You can reverse the direction of scan by turning the Main Tuning Dial in the new direction at any time during scanning.
- Stop scanning by pressing the "SCAN" key again.

Scan Type

- Busy Scan (No Display) This is the default setting. Stops at busy channel.
- Open Scan (SP). Stops at first open frequency. Push "FUNC" key and (STYP) key once to access Open Scan.
- Time Busy Scan (TM). Stops at busy frequency, holds for several seconds and continues. Push "FUNC" key and (STYP) key twice to access Time Busy Scan.
- Time Open Scan (TM SP). Stops at open channel, holds for several seconds and continues. Push "FUNC" key and (STYP) key three times to access Time Open Scan. (Four times returns to Busy Scan).

Priority

(VFO)

- VFO Priority monitors the VFO frequency for five seconds and a selected Memory channel for one second.

(Memory)

- From VFO mode, push "PRI" key to start, and push again to stop.
- Memory Priority monitors a selected Memory channel for five seconds and the VFO frequency for one second.

(Call)

- From Memory mode, push "PRI" key to start, and push again to stop.
- Call Priority monitors the programmed CALL channel for five seconds and the VFO frequency for one second.

AutoPatch

(EJ-8U Required)

- From the Mic enter "C13", and select the desired AutoPatch channel with the MHz Up/Down key.
- Enter phone number, etc. (up to 16 digits).
- Press the PTT to store number.
- Enter "C14" and then select the desired AutoPatch channel with the MHz Up/Down key.
- To transmit, press and hold the PTT, and enter "15".

Remote

(From Mic)

- Enter commands to change frequencies, modes, functions, and features directly from the Touch Tone Pad on the Mic.
- To change frequency, select band (VHF/UHF) and enter all six (06) digits of the new frequency.
- To change modes, features, or functions, enter the proper "Cxx" command.

Below is a chart listing all commands:

[CHART]

Code	Function	
C00	CANCEL	Cancels Function
C01	VFO	Select VFO Mode
C02	MR	Select Memory Mode
C03	CALL	Select CALL Mode
C04	ARM	Select ARM Mode
C05	VHF	Select VHF Band
C06	UHF	Select UHF Band
C07	H/M/L	Select Power Output
C08	MHz	Up One MHz (or Memory Channel Up — In Memory Mode)
C09	MHz	Down MHz (or Memory Channel Down — In Memory Mode)
C10	DSQ	Set DSQ Code
C11	DSQ	Select DSQ Code
C12	DSQ	Select DSQ Mode
C13	DIALER	Set Autodialer
C14	DIALER	Select Autodialer
C15	DIALER	Transmit Autodialer

Remote Control

(From Remote Transceiver)

- From VFO mode, set frequency, Offset, CTCSS Tone, etc, or select desired Memory channel.
- Enter "C10" from Mic.
- Enter DSQ channel No. (1 — 3), and Access Code (any three digits). You will enter a total of 4 digits. Ex: 1234 (1=DSQ channel) (234=Access Code).
- Enter "C12" from Mic. (DSQ indicator flashes), push PTT (DSQ indicator stops flashing).
- Press "FUNC" key and MHz Up button (DSQ indicator starts flashing again).

Note: Store DSQ (using above steps) into every memory channel that you may want to remote control. Use the minimum number of channels necessary for your application, because the DR-599 will NOT give a Frequency/Memory Channel confirmation back to the remote transceiver.

DTMF Commands

Cross-band repeat (Remote)

Change Frequency

- Remote Control uses the same "Cxx" command codes as shown in preceding chart.
- Cross-band repeat ON: "D-99".
Cross-band repeat OFF: "D-01".
- You can step Up or Down 1 MHz in frequency in the Main (transmitting) Band [if it is programmed for remote control] with the "C08" or "C09" command.
- You can directly enter any frequency (5 kHz step) in the Sub-Band ONLY. Enter "A" on the Mic., then all six (06) digits of the new frequency.

Note: The DR-599 has been designed to work as a CLOSED cross-band repeater when remote controlled. This means that the person with the access code is the control operator, and he alone can control the machine. It will also work as an OPEN cross-band repeater (see below), but cannot be remote controlled in this mode. If both bands are programmed with DSQ codes, then both parties transmitting through the machine will have to send a 3-digit access code every transmission. (This can be inconvenient if the parties are using radios that don't have the automatic DSQ feature). A way around this is to only program the "Control" channel (VHF or UHF) with DSQ. The sub-band frequency can then be changed with the "A" command, and the person talking through this channel does not need to send any code. The control operator still needs to send the 3-digit access code every transmission.

Cross Band Repeat

(Open)

- To turn on, Press and hold "FUNC" key, then press VHF key.
- To turn off, Press and hold "FUNC" key, then press UHF key.

DSQ DTMF Paging

- Enter "C10" DSQ channel no. and 3 digit code into each DSQ channel:
Self Station DSQ Channel 0
Group Stations DSQ Channel 1 — 3
Remote Station DSQ Channel 4

Transmitting DSQ

- Enter "C12" on the Mic ("DSQ" displays), press PTT to enter DTMF Squelch Control.
- Enter "C11" on the Mic and use the MHz Up/Down key to choose DSQ Channel (1 — 3).
- Push PTT to transmit DSQ code. Any compatible transceiver with same 3 digit code programed will open squelch, and receive the transmission.
- Enter "C12" on the Mic and use MHz Up key to select P DSQ. Press PTT to set P DSQ.
- Push PTT to transmit P DSQ codes (3 digits of DSQ channel 4 [Remote Station Code], "*" sign, and 3 digits of DSQ channel 0 [Self Station Code]). Any compatible transceiver with same codes programed will open squelch, and receive the transmission.
- Enter "C12" on the Mic and use MHz Up key to select G DSQ. Press PTT to set G DSQ.
- Enter "C11" and use MHz Up/Down key to select one of the three different Group Codes (DSQ channels 1 — 3).
- Push PTT to transmit G DSQ codes (3 digits of selected [Group Code] DSQ channel 1 — 3, "*" sign, and three digits of DSQ channel 0 [Self Station Code]). Any compatible transceiver with same codes programed will open squelch, and receive transmission.
- Enter "C12" on the Mic and use MHz Up key to select PG DSQ. Press PTT to set PG DSQ.
- Choose a Group code (DSQ channel 1 — 3) as described above.
- Press PTT to transmit PG DSQ codes (3 digits of selected [Group Code] DSQ channel 1 — 3, first digit of DSQ channel 4 [Remote Station Code], "*" sign, and first digit of DSQ channel 1 [Self Station Code]). Any compatible transceiver with the same codes programed will open squelch, and receive the transmission.

P DSQ
(Private Paging)

G DSQ
(Group Paging)

PG DSQ
(Private Paging
in a Group)

Receiving

- Program and set the DR-599 as described above. Whenever a remote transceiver sends signal with proper DSQ codes, your DR-599 will break squelch and receive the transmission.

Initial Control Settings

1. Connect 13.8V DC power supply and antennas. Ensure that the antennas are connected to proper band connectors. Set switches and controls as indicated below:
POWER: OFF
D.C. POWER SUPPLY: OFF
VOLUME CONTROLS: Fully counter clockwise
SQUELCH CONTROLS: Fully counter clockwise

Initial factory-delivered settings or reset modes for Frequency, Memory Channel, and Other Functions:

VHF		UHF	
VFO frequency	: 145.000 MHz	UHF frequency	: 445.000 MHz
Memory Channel	: 1	(DR-599E	: 435.000 MHz)
Channel Step	: 5 kHz	Memory Channel	: 15
Shift	: 0	Channel Step	: 5 kHz
Offset Freq.	: 0.6 MHz	(DR-599E	: 12.5 kHz)
Tone Encoder	: None	Shift	: 0
Tone Freq.	: 88.5 Hz	Offset Freq.	: 5 MHz
DTMF Squelch	: None	(DR-599E	: 7.6 MHz)
Memory Freq.	: 145.000 MHz	Tone Encoder	: None
Scan Type	: Busy Scan	Tone Freq.	: 88.5 Hz
ARM Base	:	DTMF Squelch	: None
ARM	:	Memory Freq.	: 445.000 MHz
DSQ Code	: 111	(DR-599E	: 435.000 MHz)
Autodialer	: None	Scan Type	: Busy Scan
		DSQ Code	: 111
		Autodialer	: None

2. Turn On the power supply, then press radio Power switch. Display will indicate frequencies and V.
3. Adjust Volume controls on each band until a signal (or noise) is heard.
4. Rotate main tuning dial to select an open frequency on each band, then rotate Squelch controls on each band until noise just disappears.
5. Select desired Main Band (V or U) by pressing "VHF BAND UHF" switch on the front panel.
6. When turning power off, switch transceiver power off before turning off power supply or vehicle engine.

Frequency Selection

Select either the VHF Band or the UHF Band as the Main (transmitting) Band.

If VHF is selected the V symbol will appear to the left of the VHF frequency display and most of the command and control functions will be active on the band. If UHF is selected the U symbol will appear to the left of the UHF frequency display and most of the command and control functions will be active on the band.

The desired Main Band operating frequency may be selected by rotating the main turning dial in either direction or by using the UP/DOWN switches on the microphone. Direct frequency is also possible by simply entering all 6 digits of frequency into the microphone.

Cautions:

Ensure that antennas are attached to the correct antenna terminal (i.e.: VHF antenna to VHF antenna terminal and UHF antenna to UHF antenna terminal). Check markings on antenna terminal barrel for proper antenna hook-up. Always use an antenna with low Standing Wave Ratio (SWR) readings. Improper antenna termination may cause damage to transmitter final amplifier.

The DR-599 has two bands, both of which are visible on the LCD display. The VHF band is on the left and HF band is on the right.

1. Before transmitting select the desired Main (transmitting) band with the VHF and UHF selector buttons on the front panel.
2. Check to see if frequency is occupied before transmitting.
3. Select appropriate transmitter output power level by cycling H/M/L key on the front panel until minimum power for the intended transmission is indicated on the LCD panel.
4. Press PTT switch and speak into microphone. ON AIR indicator will illuminate while transmitting.
5. Release PTT switch. ON AIR light goes out and unit returns to receive.

Transceiver Modes

DR-599 has 3 modes; VFO mode, MEMORY mode, and CALL mode.

1. VFO Mode (Variable Frequency Oscillator)

Press the VFO key. The transceiver will be in VFO mode.

This mode is used to change frequency and select desired channel step, offset frequency (up to 10.995 MHz by 5 kHz), tone frequency (38), etc.

2. MEMORY Mode

Press the MR key. Programed frequency and memory channel number will display on the LCD. There are a total of 28 memory channels for VHF and UHF. To change Memory Channel number press the MHz Up/Down key.

3. CALL Mode

Press the CALL key. The transceiver will be in CALL mode.

The CALL Mode allows a single key to immediately access a programed frequency.

PROGRAMING FUNCTIONS AND FEATURES

The DR-599 has several Primary and Secondary functions and features.

Primary Functions and Features

These are accessed directly by pressing the appropriate control panel key. A brief description of these functions and features can be found in the Controls and Functions section of this manual.

Secondary Functions and Features

These are accessed when the appropriate control panel key is used in combination with the "Func" key. Secondary Functions and Features are printed in Green on the control panel of the DR-599.

This manual shows and described all Secondary Functions and Features in italics.

REPEATER OPERATIONS

Amateur radio repeaters utilize separate transmitter and receiver frequencies. The transmitter frequency may be offset either above or below the receive frequency according to repeater coordination conventions. Repeater offsets are sometimes referred to as "splits".

To select Repeater Offset Frequency and Direction:

1. Select VFO mode, select desired repeater output frequency and press the SHIFT key. Each time the SHIFT key is pressed, the offset indicator will cycle through the various offset options.
2. The current offset (usually 0.60) and the minus sign (-) will appear first on the LCD display panel, indicating a minus offset of 0.60 MHz (600 kHz). In this position the desired offset frequency may be selected by rotating the Main Tuning Dial in either direction. The DR-599T/E accepts offsets in either direction, from 0.00 to 10.0 MHz in 5 kHz steps.
3. Press the PTT switch to store the selected offset, and return to the selected repeater frequency.
4. Pressing the SHIFT key again will show the VFO frequency and the plus (+) offset indicator on the LCD display panel. Press the microphone PTT switch to store the frequency and the plus (+) offset.

5. Pressing the SHIFT key again will show the VFO frequency but neither the minus (-) nor the plus (+) offset direction indicator. In this mode the transmitter is not offset from the receiver frequency and simplex operation is possible. The radio will transmit and receive on the same frequency.

VFO

This function is accessed by pushing the VFO key. The DR-599T/E will access the last VFO frequency entered.

VFO is the required mode for programing many functions of the DR-599T/E. This manual will specify if it is necessary to use the VFO mode to program a specific function.

CHANNEL STEP

In combination with the "Func" key, press the (CH.SP) key. The programed spacing between frequencies will be displayed in kHz. The factory setting is 5.0 kHz. Set the desired spacing (step) by turning the main tuning dial (clockwise increases the step, counter clockwise decreases the step); or the Up/Down buttons on the microphone. Channel Steps (Spacing) is fixed at 5.0 kHz, 10.0 kHz, 12.5 kHz, 15.0 kHz, 20.0 kHz, or 25.0 kHz increments.

FREQUENCY SELECTION

The DR-599T gives you several ways to select and set your receive/transmit frequency:

- (a) Main tuning Dial. Turn clockwise to move the VFO up, or counter clockwise to move the VFO down. The frequency will change in accordance with the Channel Step you have most recently set.
- (b) Microphone Touch Tone Keypad/Direct Entry (Standard on the DR-599T/Optional on the DR-599E). Set the "lock" switch to the right (lock "OFF"), and the Remote/DTMF switch to the "Remote" position (to the left). Enter all 6 digits of the new frequency (if the Ch.Sp. is set for 5, 10, 15, 20, 25 kHz — if Ch.Sp. is set at 12.5 kHz, only 5 digits are required).
- (c) MHz Up/Down key. You can increase/decrease your receive/transmit frequency by 1 MHz by pushing the MHz-Up or MHz-Down keys. Change frequency in kHz steps by turning the Main Tuning dial.

(CTCSS) (SUB-AUDIBLE) TONE SELECTION

- (a) Tone Encode — Push the "Tone" key and the sub-audible tone frequency (in kHz) will display on the LCD for the selected VHF or UHF band. Change the tone frequency by turning the Main Tuning Dial (clockwise to increase, or counter clockwise to decrease). The DR-599T has 38 settings from 67.0 kHz to 250.2 kHz.

ENC will display on the LCD, indicating that the selected Tone will be encoded (transmitted) with the carrier frequency.

"One purpose of CTCSS is to reduce co-channel interference during band openings. CTCSS equipped repeaters will respond only to signals having the CTCSS tone required for that repeater."

To return to VFO, push the VFO key or the PTT.

- (b) Tone Decode — With the optional EJ-7U Tone Unit installed, you can set CTCSS decode by pushing the "Tone" key immediately after setting the tone frequency (without returning to VFO). DEC will display on the LCD, indicating that received CTCSS tones will be decoded. The purpose of CTCSS decoding is to selectively receive transmissions. Only those transmissions that have the appropriate sub-audible [CTCSS] tone will be received by the DR-599T/E.

SHIFT/REPEATER OFFSET

To select the Shift, press the "shift" key. Press once and a "-" indicator will display on the LCD, along with the offset (displayed in MHz). Default settings are: 0.60 MHz for VHF and 5.00 MHz for UHF.

Select the appropriate offset by turning the Main Tuning Dial (clockwise to increase, counter clockwise to decrease), or you can use the Up/Down keys on the microphone.

By pressing the "shift" a second time, a "+" indicator will display on the LCD.

The “-” display indicates that the transmit frequency (when the PTT is pushed) will be below the receive frequency. The “+” display indicates that the transmit frequency (when the PTT is pushed) will be above the receive frequency.

Return to VFO to transmit, by pushing the VFO key or the PTT.

MEMORY PROGRAMING AND OPERATIONS

MEMORY RECALL

To select the memory mode, press the “MR” key. The most recently used memory channel will show on display.

In the Memory mode, you can scan the memory channels with the “Scan” key, elect to skip any memory channel with the (Skip) key, or select the scan type with the (S.TYP) key (the programing these functions is detailed further in this manual).

The memory recall is designed to allow the operator to quickly select or scan specific frequencies (either simplex or repeater), and store necessary parameters for transmitting on those frequencies.

The DR-599T/E has two banks of memory channels: The main bank of memory channels that are accessed with the MR(MW) key, and the ARM memory channels. ARM gives you 10 additional memory channels.

MEMORY WRITE

Two write (or record) functions to any memory channel, it is necessary to first set those functions in the VFO mode.

Note: Several of the memory channels have been reserved for “Special Functions”: Channels 1L, 1U, 2L, & 2U are reserved for Program Scanning, and Channel A is reserved for programming the ARM memory channels.

- (1) Select VFO mode, as described above.
- (2) Select the VHF or UHF band, as described above.
- (3) Select the receive frequency, as described above.
- (4) Select the repeater shift (- or +), and the required offset as described above (if required — consult your Repeater Directory).
- (5) Select the proper [CTCSS] sub-audible tone, as described above (if required — consult your Repeater Directory).
- (6) Program remote controlling feature (DSQ) if desired (procedure explained later in this manual).

It is possible to store many features and functions in the DR-599T memory channels:

- (a) Receive/Transmit frequency
- (b) Repeater Shift (- or +)
- (c) Repeater Offset (in 5 kHz steps)
- (d) [CTCSS] sub-audible Tone Frequency
- (e) CTCSS Tone Encode
- (f) CTCSS Tone Decode (with optional EJ-7U Tone Board installed)
- (g) Remote Control Programing.

After selecting and setting the required functions you can write (store) those functions to a memory channel in several ways.

1. Main Tuning Dial Method
 - (1) Select VFO mode.
 - (2) Select a frequency, shift direction, shift value, and CTCSS tone frequency.
 - (3) Press the “Func” key, and the “Func” and memory channel number will be displayed on the LCD.
 - (4) Turn the Main Tuning Dial clockwise to choose the desired memory channel number (clockwise to increase, counter clockwise to decrease).
 - (5) When you have selected the memory channel you want, push the (MW) key to write (store) to memory. The LCD will return to VFO, and selected functions will be stored in the last displayed memory channel.

You may store VHF or UHF frequencies and functions in any one of the 28 memory channels. Be advised that there are only 28 main memory channels. Storing a VHF or UHF frequency in any channel will utilize that channel for that band ONLY. You will have to over-write on that used channel to utilize it for another band. for example: the factory setting shows memory channels 1 — 14 on the VHF band side, and 15 — 28 on the UHF band side. You can store a VHF frequency and functions in channel 18, 21 and 23. That channel will then be displayed on the VHF band side, and no longer on the UHF band side. Scrolling through the UHF band side will display 15, 16, 17, 19, 20, 22, 24, 25, 26, 27, 28 only. Channel 18 will not display on the UHF band side.

2. MHz Up/Down Method

- (1) Select the desired VHF or UHF band, as described above.
- (2) Select memory recall and use the MHz key to select the desired memory channel. You will only be able to select those memory channels displayed on the band (VHF or UHF) you initially selected.
- (3) Return to VFO.
- (4) Set your frequency and functions, as described above.
- (5) Press “Func” key first, and then the (MW) key. The frequency and functions chosen will be stored into the previously selected memory channel.

ADDITIONAL REPEATER MEMORY

ARM Memory Recall

To access the ARM bank of memory channels push the ARM key. “A” and the memory channel number will display, indicating that you are in the ARM bank of memory channels. You can engage the same features in the ARM memory bank as you can in the main bank of memory channels.

You can scan, skip and set the type of scanning in these memories by engaging those functions, described later in this manual.

You can scroll the ARM by:

- (1) Turning the Main Tuning Dial; clockwise to increase, or counter clockwise to decrease.
- (2) Pushing the Up/Down keys on the microphone.
- (3) The MHz Up/Down keys on the front panel.

ADDITIONAL REPEATER MEMORY

ARM Memory Write

To write (or record) functions to any ARM memory channel, it is necessary to first set those functions in the VFO mode.

- (1) Select VFO mode, as described above.
- (2) Select the VHF or UHF band, as described above.
- (3) Select the receive frequency, as described above.
- (4) Select the repeater shift (- or +), and the required offset as described above (if required — consult your Repeater Directory).
- (5) Select the proper [CTCSS] sub-audible, tone, as described above (if required — consult your Repeater Directory).
- (6) Program remote controlling feature (DSQ) if desired (procedure explained later in this manual).

It is possible to store many features and functions to the DR-599T ARM memory channels:

- (a) Receive/Transmit frequency
- (b) Repeater Shift - or +
- (c) Repeater Offset (at 5 kHz steps)
- (d) [CTCSS] sub-audible Tone Frequency
- (e) CTCSS Tone Encode
- (f) CTCSS Tone Decode (with optional EJ-7U Tone Board installed)
- (g) Remote Control Programing.

After selecting and setting the required functions you can write (store) those functions to an ARM memory channel with the following procedure only.

- (1) Select VFO mode.
- (2) Select a frequency, shift direction, shift value, and CTCSS tone frequency.
- (3) Press the “FUNC” key, and the “FUNC” and memory channel number will be displayed on the LCD.
- (4) Turn the Main Tuning Dial clockwise to the “A” memory channel number (clockwise to increase, counter clockwise to decrease).
- (5) Push the (MW) key. The initial setting is complete. The LCD display will return to the VFO mode.

- (6) Press the microphone PTT switch. If the DR-599T transceiver receives an answer signal from the repeater the frequency and other functions will be memorized in channel A1.
- (7) If the repeater is not equipped to answer your DR-599T/E and set the memory channel, it will be necessary to manually write your selection into the first available open ARM memory channel. Just press the function key and (ARMW) key.

If all the ARM memory channels are utilized, the next programmed frequency written to the ARM will be placed in ARM channel A1 automatically. You can NOT choose pacific ARM memory channels to over-write or change.

Important Note:

The ARM is limited to recording within the initial MHz frequency.

Example: Initial frequency "A1" is set at 147.015 MHz, then the highest frequency that can be stored in the ARM bank of memory channels will be 145.995. If "A1" is set at 445.995 it will be impossible to set any more memory channels in ARM.

CALL MEMORY Recall

To access the frequency you have stored in the CALL Memory channel, push the "CALL" key.

CALL MEMORY Write

You can set a desired frequency (and other functions) into your CALL Memory Channel.

- (a) Select VFO mode.
- (b) Select the frequency you want to store as your CALL frequency, repeater input shift, PL tone, etc.
- (c) Push the "FUNC" key, and FUNC indicator will display on the LCD. Push the (CALLW) key to store frequency to the CALL Memory channel.

SCAN

The DR-599T/E offers 4 scanning options and 4 scanning types.

Scanning Options:

- (1) Band Scan (VFO mode) — scans entire band. In this scan option all MAIN BAND VFO channels are scanned by pressing the "SCAN" key. The frequency decimal point will flash to indicate scanning in progress. In the BAND SCAN mode no scan type symbol is displayed on the LCD panel. The scanning direction may be reversed by rotating the Main Tuning Dial in the direction opposite to the current scan direction. Pressing the appropriate Up/Down microphone switch, in Remote mode, also reverses the scan direction. All 4 scan types can be applied to Band Scan.
- (2) Program Band Scan (VFO mode) — scans programmed lower to upper frequencies. This scan option allows the scanning of a range of VFO frequencies between user selected Lower (L) and Upper (U) band frequencies (the transceiver must be in the VFO mode to initiate this scanning option). Frequency Lower and Upper ranges are stored in 1L & 1U respectively for the VHF Band, and 2L & 2U respectively for the UHF Band.

Storing the Lower and Upper Ranges:

- (a) Select VFO mode.
- (b) Select desired Lower Frequency.
- (c) Press the "FUNC" key. FUNC and channel number will appear on the LCD.
- (d) Rotate the Main Tuning Dial until 1L (for the lower VHF frequency or 2L for the lower UHF) is displayed.
- (e) Press the "MW" key to store the selected Lower Frequency to memory.
- (f) Press the "FUNC" key. FUNC and channel number will appear on the LCD.
- (g) Rotate the Main Tuning Dial until 1U (for the upper VHF frequency or 2U for the upper UHF) is displayed.
- (h) Select any frequency between the programmed lower and upper limits.
- (i) Press the "SCAN" key to start scanning between the programmed lower and upper limits. Scan direction can be selected by turning the Main Tuning Dial in the desired scan direction.

- (3) Memory Scan — scans memory channels in selected band.

This scan option allows the user to scan frequencies that have been programmed in any (or all) of the memory channels. Bands may be scanned individually or both bands may be scanned simultaneously. And the direction of scan (up or down) can be set by pressing the appropriate MHz Up/Down key prior to, or during, the scan operation. To store desired frequencies (or other functions) to memory channels, see the section of this manual entitled "Memory Write".

- (4) Memory Channel Skip — permits unwanted memory channels to be skipped during memory scan.
 - (a) Press the "MR" key to select the Memory Recall mode.
 - (b) Press the MHz Up/Down to select the memory channel to skip.
 - (c) Press the "FUNC" key then the (SKIP) key. The decimal point will disappear and the selected memory channel will be skipped during Memory Scan.
 - (d) To cancel Memory Channel Skip, press the "FUNC" key and then the (SKIP) key. The decimal point will re-appear, and that memory channel is restored to scan.
- (5) ARM Scan — scans ARM memory channels when ARM is selected. To initiate the ARM scan option, push the "ARM" key to select the ARM mode. Then push the "SCAN" key to start scanning the ARM memories.

Scanning Types:

- (1) Busy Scan (No Display) — Stops at busy frequency or channel until clear, then resumes scan.
- (2) Open Scan (SP) — Stops at open frequency or channel.
- (3) Time Busy Scan (TM) — Stops at busy frequency or channel, then resumes scan after several seconds.
- (4) Time Open Scan (TM SP) — Stops at open frequency or channel, then resumes scan after several seconds.

Engaging Scan Function and Selecting Scan Type:

- (1) Select mode, VFO, Memory, or ARM.
- (2) Select scan type, press "FUNC" key then (S.TYP).

- (a) Initial setting (No Display) indicates that "Busy Scan" is selected.
 - (b) [Func/S.TYP Once] "SP" displays indicating that "Open Scan" is selected.
 - (c) [Func/S.TYP Twice] "TM" displays indicating that "Time Busy Scan" is selected.
 - (d) [Func/S.TYP Three Times] "TM SP" displays indicating that "Time Open Scan" is selected.
- (3) With the proper scan type selected, press the "SCAN" key to start scanning. The decimal point indicator will flash while the DR-599T/E is in the scan mode. Note: In any scan mode, you can manually override a "stop" and resume scanning by rotating the Main Tuning Dial.
 - (4) To stop scanning, push the "SCAN" key once more. The decimal point indicator will stop flashing, confirming that the DR-599T/E is no longer in the scan mode.

PRIORITY FUNCTION

This function allows a one second scan of the user-selected priority frequency and a five second scan of the other frequencies in the VFO Priority, Memory Priority, and Call Priority modes.

- (1) VFO Priority
Desired priority frequency stored in any of the main Memory Channels will be scanned for one second, and the last selected VFO frequency will be scanned for 5 seconds.

Programing VFO Priority

- (a) Store desired frequency in any memory channel.
- (b) Select VFO mode and a VFO frequency.
- (c) Press the "PRI" key. The PRI indicator will appear on the LCD and VFO Priority scan will begin. The (last) selected memory channel will be scanned for one second, the VFO frequency will be scanned for five seconds.

If the microphone PTT is pressed while on the VFO frequency, the priority channel will NOT engage until the PTT is released.

If the microphone PTT is pressed while on the priority channel (memory channel 1), the Priority function will be canceled, and the transceiver will remain on memory channel 1.

- (d) Press the "PRI" key again to cancel VFO Priority scan. The DR-599T/E will return to the VFO frequency.

(3) Memory Priority

This is the reverse of the VFO Priority mode. The VFO frequency will be scanned for one second and the memory channel will be scanned for five seconds.

Programing Memory Priority

- (a) Select VFO and a VFO frequency.
- (b) Press MR to select memory mode, then select a memory channel containing the desired memory frequency to be scanned (any memory channel in the main [transmitting] band can be selected for Memory Priority Scan, you are not restricted to memory channel 1, as in VFO Priority Scan).
- (c) When you are in the memory mode, press the "PRI" key. PRI indicator will appear on the LCD and Memory Priority Scan will begin. The VFO frequency will be scanned for one second and the selected memory channel will be scanned for five seconds.
Like the VFO Priority Scan, if you press the PTT switch while on the memory channel, priority scan will stop until the PTT is released. If the PTT is pushed while on the VFO frequency, Priority Scan will be cancelled and it will return to the memory channel.

(4) CALL Priority

The VFO frequency is scanned for one second and the programed CALL frequency is scanned for five seconds.

- (a) Push the "CALL" key to access your programed CALL frequency.
- (b) Push the "PRI" key, the PRI indicator will display on the LCD, and the CALL channel will be scanned for five seconds, and the current VFO frequency will be scanned for one second.

AUTOPATCH OPERATION

(Requires Optional DTMF Unit)

Many repeaters offer a telephone link known as an autopatch allowing use of the DR-599T/E in much the same manner as a mobile (or cellular) telephone. The DTMF (Dual Tone Multi Frequency) key pad on the supplied microphone (standard only on the DR-599T) is used to activate an autopatch and other repeater user functions. The repeater control operator or regular repeater users can advise how these functions are used.

is used to activate an autopatch and other repeater user functions. The repeater control operator or regular repeater users can advise how these functions are used.

AUTODIALER

(Requires DTMF Unit [EJ-8U] for T & E Versions & 16 Tone DTMF Mic [EMS-3Z] for E Version)

This function is used to transmit a memorized DTMF code, such as a telephone number, up to 16 digits. The DR-599T/E has four autodialer memory channels accessible to either VHF or UHF band. It also has one memory channel in each band for receiving DTMF codes, this channel is NOT programmable directly from the DR-599T.

To Program The Autodialer:

- (1) Select the desired band (UHF or VHF), and VFO mode.
- (2) Enter C13 on the 16 Tone DTMF Mic Pad (EMS-3Z, is the standard Mic for the US (T) version only. EMS-3Z is the optional Mic for the European version). A channel number and flashing minus (-) sign will appear.
- (3) Select the desired channel number using the MHz Up/Down key on the front panel. Each time the MHz Up/Down key is pressed the channel number will change up (or down) from one to five. When channel 5 appears, it will display a flashing letter "d" in place of the flashing minus (-) sign. Channels 1 thru 4 are transmit autodialer memory channels. Channel 5 is the DTMF monitor channel (see DTMF Monitor section in this manual).
- (4) Enter desired telephone number and any required codes, up to 16 digits.
- (5) To store phone number and/or DTMF codes, press the "VFO" key (or the PTT switch on the Mic).
- (6) To cancel a stored telephone number, enter C13 on the DTMF pad, then select the appropriate autodialer channel number. When the proper channel number is selected, press the "FUNC" key and then the (SKIP) key. Any programed numbers or codes in that Autodialer memory channel will be erased.

Transmitting A Stored Autodialer Number

(The Optional DTMF Unit (EJ-8U) is required).

- (1) Select the VFO mode, then select the transmitting frequency.
- (2) Enter C14 on the DTMF Mic pad, and select the desired Autodialer channel with the MHz Up/Down key (only channels with phone numbers or codes programed in will be accessible, any empty channels will not be accessible). Return to VFO mode by pushing the PTT switch on the Mic. or "VFO" key on the front panel.
- (3) While holding the PTT key on the Mic, enter C15 on the DTMF pad (Remote/DTMF switch must be in the "Remote" position, NOT the "DTMF" position).

DTMF Monitor

(The Optional DTMF Unit (EJ-8U) is required).

A received DTMF code may be memorized in the Autodialer channel 5. This memory can store up to 10 digits. To confirm a received DTMF code has been stored in channel 5:

- (1) Enter the C13 code on the DTMF pad.
- (2) Press the MHz Up/Down switch on the front panel, to access channel 5.
- (3) If a DTMF code has been received it will be displayed on the LCD. Push the Up key on the Mic to scroll through the received DTMF code. Five digits at a time will be displayed on the LCD.

DETACHABLE CONTROL

(From the 16 Tone DTMF Pad on the Mic (EMS-3Z)/Optional on "E" version.)

The DR-599T/E offers a detachable front panel, with control from the Touch Tone Pad on the Mic ((EMS-3Z) Standard on U.S Version).

Control From the Microphone:

- (1) Send command Codes from the Mic. All microphone controlled functions are accessed by entering a series of 3 (three) command codes from the 16 Tone Pad on the Microphone. The "Lock" switch on the Mic MUST be in off position (right side). And the Remote/DTMF switch on the Mic MUST be in the "Remote" position (left side). Access the desired function by entering the correct 3 digit code on the Mic.

Below is a command control chart listing all control command codes:

- (2) Changing the VFO Frequency from the Mic. There are two methods of changing the VFO frequency of the main band (VHF or UHF) directly from the Mic.
 - (a) 1 MHz Step. Enter C08 to go up 1 MHz or C09 to go down 1 MHz.
 - (b) Direct Entry. From the VFO mode, enter the new frequency desired. You must enter all 6 digits of the frequency (if Step is set at 12.5 kHz you will only need to enter 5 digits to change the VFO frequency).

Code	Function	
C00	CANCEL	Cancels Function
C01	VFO	Select VFO Mode
C02	MR	Select Memory Mode
C03	CALL	Select CALL Mode
C04	ARM	Select ARM Mode
C05	VHF	Select VHF Band
C06	UHF	Select UHF Band
C07	H/M/L	Select Power Output
C08	MHz	Up One MHz (or Memory Channel Up — In Memory Mode)
C09	MHz	Down MHz (or Memory Channel Down — In Memory Mode)
C10	DSQ	Set DSQ Code
C11	DSQ	Select DSQ Code
C12	DSQ	Select DSQ Mode
C13	DIALER	Set Autodialer
C14	DIALER	Select Autodialer
C15	DIALER	Transmit Autodialer
<hr/>		
D99	REPEATER	Turn ON Cross Band Repeater
D01	REPEATER	Turn OFF Cross Band Repeater

REMOTE CONTROL

(Optional DTMF Unit (EJ-8U) Required)

The DR-599T/E can be controlled by a DTMF capable remote transceiver, from any location within transmit/receive range of the DR-599T/E and remote unit. Functions such as: Cross Band Repeating, Accessing and Changing Memory Channels, Selecting Output Power, Selecting Main Band, and many others can be controlled from a remote unit. This exciting feature of the DR-599T/E gives the operator the ability to transmit from a low power Hand Held Unit through the DR-599T/E (Cross Band Repeat) with 45 Watts (approx.) on VHF or 35 Watts (approx.) on UHF.

- (1) Select VFO mode, and set desired frequency.
- (2) Make sure "Lock" switch on Mic is off (Right), and "Remote/DTMF" switch is in "Remote" position (Left).
- (3) Enter C10 on the Touch Tone Pad of the Mic. The frequency indicator on the main band (VHF/UHF) will blink on and off repeatedly.
- (4) On the Touch Tone Pad of the Mic enter a channel selection (three numerical digits, any selection from 000 to 999). Immediately after entering the third digit of your access code (total of four digits, including the channel selection) the DR-599T/E will return to VFO mode.
DR-599T/E will return to VFO mode.
- (5) Enter C12 on the Touch Tone Pad of the Mic. Flashing DSQ indicator will appear.
- (6) Push the PTT key on the Mic, or the "VFO" key on the front panel. The DSQ indicator will stop flashing.
- (7) Push the "FUNC" key, and then the MHz Up key on the front panel. There will be a confirming tone, and the DSQ will begin flashing (on and off) again.
- (8) To cancel the Remote Control Function, enter C12 on the Mic and press the MHz Down key. DSQ indicator will disappear.

At this point the Remote Control Function is programmed into the DR-599T/E, and it can be controlled from a remote unit. It is recommended that this programming be stored in every memory channel that you may want to work remotely. To maintain Remote Control of the DR-599T/E it is necessary to have the flashing DSQ displayed on the LCD. If you change to modes (VFO or Memory), or memory channels that

DON'T have a flashing DSQ programed YOU WILL LOSE REMOTE CONTROL. The DTMF 3 digit codes for Remote Controlling are the same as used when controlling the DR-599T/E from the Touch Tone Pad on the Mic (see the "Controlling from a Mic" section of this manual).

Changing the VFO Frequency from the Mic.

There are two methods of changing the VFO frequency of the main band (VHF or UHF) directly from the Mic.

- (a) 1 MHz Step. Enter the programed three digit access code. Enter C08 to go up 1 MHz or C09 to go down 1 MHz.
- (b) Direct Entry. From the VFO mode, enter the programed three digit access code. Then enter the "A" and the new frequency desired. You must enter all 6 digits of the frequency (if Step is set at 12.5 kHz you will only need to enter 5 digits to change the VFO frequency).
You can only change frequency directly on the sub-band from the main band (ex.: Change VHF frequency from UHF or change UHF frequency from VHF). Also the flashing DSQ indicator must be programed to the main band (ex.: if you want to change the VHF frequency, you can only do that from the UHF band side, and the UHF band must have the flashing DSQ indicator on).

When you enter the "A", the main band display will go blank. New frequency digits will appear as they are entered. When the sixth digit is entered, the original display frequency of the main band will return, and the new frequency of the sub-band will appear on the sub-band side.

(Ex.: VHF shows 145.00 and I want to change that to 145.225. I will enter my 3 digit access code (keeping the PTT held down), enter C06 to select UHF as the main band (keep the PTT held down), enter "A" (the UHF display goes blank) and enter my new VHF frequency (shows up on the UHF side). When the 6th digit is entered, the original UHF frequency comes back, and the VHF side shows the new frequency 145.225.)

The procedure for storing "Remote Control" to a memory channel is the same as storing any other feature or function to memory, described earlier in the "Memory Write" section of this manual.

- (1) Select VFO, and Program the Remote Control function (as described above).
- (2) Select frequency, set shift (-/+), set offset, select CTCSS tone (whatever is required).
- (3) Press the "FUNC" key (the FUNC indicator appears) and rotate the Main Tuning Dial to select the desired memory channel (remember that there are some "special" use channels, that can not be utilized for storing the Remote Control Function).
- (4) Press the (MW) key to store all selected features and functions to the selected memory channel.

CROSS BAND REPEATER

(VEHICLE EXTENDER)

The DR-599T/E is capable of operating as a Cross Band Repeater. The DR-599T/E will receive a transmission on one band (VHF or UHF) and re-transmit on the other band.

Remarks:

It is not necessary to modify the DR-599T (T Version) and you can engage Cross Band Repeater by:

- (a) Front Panel — to Engage Cross Band Repeater function press and hold the "FUNC" key, and press the "VHF" key. To Disengage Cross Band Repeater function, press and hold the "FUNC" key, and press the UHF key.
- (b) Remote Unit — to Engage Cross Band Repeater function, transmit the pre-set DTMF (3 digit) access code [see Remote Control Section of this manual for details on how to program the access code for Remote Controlling], and transmit DTMF tones "D99". To Disengage Cross Band Repeater function, transmit the pre-set DTMF (3 digit) access code, and transmit DTMF tones "D01". The "D99" or "D01" commands will NOT work from the Touch Tone Pad on the Mic.

Note: It is not necessary to re-set the radio again to access Cross Band Repeater. Also Cross Band Repeater can be accessed from either the VFO or Memory mode.

Special Note: DR-599T/E Remote Control of Cross Band Repeat

The DR-599T/E has been designed to operate as a "CLOSED" or private Cross Band Repeater. This gives the operator, and a limited group (limited by the operator), access to the DR-599T/E and its Cross Band Repeater Function. Limited access insures that the operation of the DR-599T/E is not interfered with, either accidentally or on purpose. Additionally, limited access insures that the user will not inadvertently interfere with specified Band Plans, as established by authorized Frequency Coordinators.

Therefore, in order to transmit Cross Band on the DR-599T/E it is necessary to access the DSQ Function (DTMF Squelch Control) with the 3 digit access code (immediately prior to every transmission), to open the Squelch and pass the transmission.

DSQ (DTMF Squelch)

(Optional DTMF Unit (EJ-8U) required)

The DSQ is an abbreviated name for DTMF Squelch Control. This feature is used to DE-Code DTMF tones to open (or keep closed) the DR-599T/E squelch, and allow for receiving a transmission.

To operate DSQ, it is required to have the optional DTMF Unit (EJ-1U) and a 16 Tone DTMF Pad Microphone ((EMS-3Z) Standard with the US version, Optional with the European version).

1) DESCRIPTION OF DSQ

The DSQ is divided into two primary functional groups, Paging and Code Squelch.

DSQ has five (05) DSQ channels, divided into three specific operations. Each channel stores three (03) digits.

- (1) One Self Station Code, programed into DSQ channel No. 0.
- (2) Three Group Codes, programed into DSQ channel No.'s 1 — 3.
(You can set up three separate groups, one for each channel).
- (3) One Remote Station Code, programed into DSQ channel No. 4.

(A) DSQ Paging has three functions:

(1) Group Paging: This allows the user to Page all the members of a pre-designated group. A group is identified by seven digits, the group code (3 digits), a code delineator (the * on the DTMF pad), and the self station code (3 digits).

When the group pager function is activated, stations with the same group code can communicate with all members of the group.

The DR-599T has three channels for group codes. This allows the operator to have access to three different groups.

(2) Individual Paging: This allows the user to Page one pre-designated individual. An individual is identified by seven digits, the remote station code (3 digits), a code delineator (the * on the DTMF pad), and a self station code (3 digits).

When the individual pager function is activated, an individual with the pre-designated individual code can communicate with the DR-599T/E operator.

The DR-599T/E has one channel for individual codes.

(3) Private Paging Within A Group: This allows the user to Page one individual within a pre-designated group. An individual within a group is identified by six digits, the group code (3 digits), the first digit of a Remote Station Code, a "*", and the first digit of the pre-designated self station code.

(B) Code Squelch allows the squelch to be opened when the DR-599T/E receives a pre-designated three digit code (as programmed into any of the three group DSQ channel [1 — 3]).

2) HOW TO PROGRAM DSQ FUNCTION

DSQ has five DSQ channels, divided into three specific operations. Each channel stores three digits.

Operation	Channels	Example
Self Station Code,	DSQ channel No. 0	085 (Programed in DSQ Channel "0")
Group Codes,	DSQ channel No.'s 1 — 3	147 (Programed in DSQ Channel "1") 258 (Programed in DSQ Channel "2") 369 (Programed in DSQ Channel "3")
Remote Station Code,	DSQ channel No. 4	456 (Programed in DSQ Channel "4")

(A) DSQ Code Programming

- 1) Set the "Lock" switch on the Mic to the Unlocked position (right), and the "Remote/DTMF" switch to the remote position (left).
- 2) Select the VFO mode.
- 3) Enter C10 on the Touch Tone Pad on the Mic, the LCD will flash. Enter the desired DSQ Channel Number (0 to 4) and three digit DSQ code. The DR-599T/E will return to the VFO mode.
- 4) Repeat step 3 to program all five channels (or as many of the group channels [1 — 3] as desired).

Caution:

The "*" As a Group Separator
DSQ has reserved the "*" mark as a separator between different DSQ channels. The "*" CAN NOT be used as any digit of a three digit DSQ Code.
The "#" As a Wild Card
DSQ has reserved the "#" mark as a wildcard character. The wildcard allows for combining of groups. If the first (or first and second) digit of a several group codes are the same, you can replace the second and third digits (or just third digit) with a "#" mark, and thus transmit to all those groups.

Ex: Group Code (DSQ Channels

1 — 3)	Channel	DSQ Code	Wildcard
1	123	12 #	
2	124	12 #	
3	156	1 # #	

In this example, the user could contact two (or all three) groups together, not separately as would be the case if "*" as wildcard was not used.

(B) Selecting the DSQ Mode

The DSQ mode consists of four features; three paging (Group, Private, and Individual within a Group) and Code Squelch. Each feature is displayed on the LCD when selected.

LCD Display	DSQ Mode Feature
DSQ:	Code Squelch
P DSQ:	Private Paging
G DSQ:	Group Paging
PG DSQ:	Individual within a Group Paging
Indicator Off:	No DSQ Setting

- (1) Set the "Lock" switch on the Mic to the Unlocked position (right), and the "Remote/DTMF" switch to the remote position (left).
- (2) Enter "C12" on the Touch Tone Pad on the Mic. The "DSQ" indicator will begin to flash confirming the Code Squelch feature selected. Then press the PTT, DSQ stops flashing.
- (3) To select Paging, Group, or Individual within a Group, press the "MHz Up" key, while DSQ indicator is flashing, until the proper indicator appears. Then press the PTT, DSQ stops flashing.

Note: When the proper DSQ mode has been selected, the DR-599T/E will only receive transmissions from another source when the proper DSQ codes are sent. Those DSQ codes will open the squelch on the DR-599T/E and allow a received signal to be monitored.

(C) Operating DSQ Paging and Squelch will allow the originating DR-599T/E to operate the squelch of a remote transceiver (compatible with the DR-599T/E)

- (1) Select the DSQ feature desired on the originating DR-599T/E. DSQ will transmit the 3, 7, or 6 digits of any selected group code.
- (2) Every time the PTT is depressed, the appropriate DSQ codes (as per selected feature) will be transmitted automatically.

(D) Description/Example of DSQ Code Transmission

1) DSQ — Code Squelch

When DSQ feature is selected, one of the Group Code (DSQ channels 1 — 3) will be automatically transmitted. You can choose which group code (DSQ channel) is transmitted by entering C11 on the Mic and using the MHz Up/Down key to select the desired channel. When the PTT is depressed, the chosen DSQ code will be automatically transmitted. Any compatible transceiver with the proper programming will open squelch.

2) P DSQ — Private Paging

When P DSQ feature is selected, the three digits of DSQ channel 4 (Remote Station Code), the "*" sign, and the three digits of DSQ channel 0 (Self Station Code), are transmitted automatically when the PTT is depressed. Any compatible transceiver with the proper programming will open squelch.

3) G DSQ — Group Paging

When G DSQ feature is selected, the three digits of the selected DSQ channel (1 — 3) (Group Code), the "*" sign, and the three digits of DSQ 0 (Self Station Code), are transmitted automatically when the PTT is depressed. Any compatible transceiver with the proper programming will open squelch.

4) PG DSQ — Individual within a Group Paging

When PG DSQ feature is selected, the three digits of the selected DSQ channel (1 — 3) (Group Code), the first digit of DSQ channel 4 (Remote Station Code), the "*" sign, and the first digit of DSQ channel 0 (Self station Code) are transmitted automatically when the PTT is pressed. Any compatible transceiver with the proper programming will open squelch.

ADDITIONAL FUNCTIONS AND OPERATIONS

1) Simultaneous Receiving and Full Duplex Operation

Among the many useful features of the DR-599T/E is the ability to receive on both bands at the same time, and also to operate in the "Full Duplex" mode. Full Duplex is similar to a telephone, where both parties can speak and listen simultaneously on two different channels.

(A) Simultaneous Receive on Both Bands:

Simply select the desired receiving frequencies on each band. Ensure that the MUTE function is not active on either band.

(B) Full Duplex Operation:

Select VFO and set the desired frequency on each band. Either band may be used to transmit. The selected Main Band will be the transmitting band. The sub-band will be the receiving band. In this mode you speak on the Main Band and listen on the sub-band. Avoid repeater frequencies. Restrict full duplex operation to established simple frequencies only.

2) ABX (Automatic Band Exchange):

This function automatically selects whichever band is active (receiving a signal) as the Main Band. To select the ABX Function, go to VFO, press the "FUNC" key and then the (ABX) key. To disable ABX, follow the same procedure.

3) MUTE

The MUTE function permits temporary silencing of either band. To select the MUTE Function, press the MUTE key, once for UHF, twice for VHF, three times to cancel MUTE.

4) LOCK

This function prevents unintended function changes by locking out all functions except the main Power switch, and the microphone PTT switch. To select the LOCK Function, press the "FUNC" key and then the "LOCK" key. To disable LOCK, follow the same procedure.

5) DIM

The DIM function allows selection of two different LCD display panel brightness levels. To change

LCD brightness level, press the "FUNC" key, then the "DIM" key. Repeated pressing of those keys will raise and lower the brightness level of the LCD.

6) CANCEL

Some mistaken operations may be corrected with the CANCEL Function.

SUB BAND FUNCTION

This function allows you to change frequency or memory channel of Sub Band while transmitting from the Main Band.

Push "F" key, then push "VHF" or "UHF" key. (i.e. when VHF is your main band, you can press "UHF" key for this function.)

Then sub Band icon ("V" or "U") will flash.

To exit this function, you can press same key as stated above.

Note:

While in Sub Band operation, some remote control commands will not be accepted if the radio is transmitting.

1) Changing Frequency or Memory Channel

In VFO mode : You can change frequency by pressing the UP/DOWN key of mic. You can also change frequency in 1 MHz steps by pressing the "MHz Up/Down" key.

In Memory Mode : You can change the memory channel by pressing the UP/DOWN key of mic or by pressing "MHz Up/Down" key.

2) VFO/Memory/Call mode

You can select either VFO/Memory/Call mode by simply pressing each key for Sub Band operation.

You cannot choose "ARM" mode in Sub Band operation.

Note:

While scanning, you cannot change frequency on Sub Band.