

# KENWOOD

HF/50MHz TRANSCEIVER

# TS-890S

## IN-DEPTH MANUAL



## COPYRIGHTS FOR THIS MANUAL

- JVC KENWOOD Corporation shall own all copyrights and intellectual properties for the product and the manuals, help texts and relevant documents attached to the product or the optional software.
- A user is required to obtain approval from JVC KENWOOD Corporation, in writing, prior to redistributing this document on a personal web page or via packet communication.
- A user is prohibited from assigning, renting, leasing or reselling the document.
- JVC KENWOOD Corporation does not warrant that quality and functions described in this manual comply with each user's purpose of use and, unless specifically described in this manual, JVC KENWOOD Corporation shall be free from any responsibility for any defects and indemnities for any damages or losses.

## IMPORTANT NOTICES FOR SOFTWARE

The software embedded in this transceiver and the optional application software consist of a multiple number of and individual software components. Title to and ownership of copyrights for each software component is reserved for JVC KENWOOD Corporation and the respective bona fide holder.

This product employs the software component in accordance with the End User License Agreement (hereinafter referred to as the "EULA") stipulated by JVC KENWOOD Corporation and/or the respective bona fide holder.

Access the URL below for details of the software component stipulated in the "GPL/LGPL".

<https://www.kenwood.com/gpl/>

The title to and ownership of copyrights for software that may be distributed individually are reserved for JVC KENWOOD Corporation. These software shall mean the software which can be embedded in KENWOOD product memories for proper operation. Any modifying, reverse engineering, copying, reproducing or disclosing on an Internet website of the software is strictly prohibited.

A user is required to obtain approval from JVC KENWOOD Corporation, in writing, prior to redistributing this manual on a personal web page or via packet communication. Furthermore, any reselling, assigning or transferring of the software is also strictly prohibited without embedding the software in KENWOOD product memories.

## COPYRIGHTS FOR RECORDED AUDIO

The broadcast content recorded in this transceiver may not be reused, except for personal use, without prior consent of the rights holder under copyright laws.

## TRADEMARKS

- KENWOOD is a registered trademark of JVC KENWOOD Corporation.
- Microsoft®, Windows®, and the Windows® logo are the registered trademarks of Microsoft Corporation in the United States and other countries.
- .NET Framework is a registered trademark of Microsoft Corporation in the United States and other countries.
- IntelliMouse and IntelliPoint are registered trademarks of Microsoft Corporation in the United States and other countries.
- All other product names referenced herein are trademarks or registered trademarks of their respective manufacturers. Marks such as ™ and ® are omitted in the body text.

## INDEMNITY

- JVC KENWOOD Corporation takes all appropriate measures to ensure all descriptions in this manual to be accurate; however, this manual may still contain typos and expressions that are misleading. JVC KENWOOD Corporation is entirely free from any responsibilities arising from any losses or damages caused by such typos or expressions.
- JVC KENWOOD Corporation has the right to change or improve the product specifications, etc., described in this manual without prior notice. JVC KENWOOD Corporation is entirely free from any responsibilities for any losses or damages caused by such changes and improvements.
- JVC KENWOOD Corporation is entirely free from any responsibilities for any failures, damages or losses arising from, or in connection with, use of the transceiver with or connected to any external equipment. Failures, damages or losses shall include the failures, damages or losses that may occur at the PC connected to the transceiver or in storage devices having memory area such as a USB flash drive. JVC KENWOOD Corporation is entirely free from any responsibilities for any secondary failures, damages or losses, including but not limited to the loss or damage of data or data files stored in these memories.
- JVC KENWOOD Corporation does not warrant that quality and functions described in this manual comply with your purpose of use and, unless specifically described in this manual, JVC KENWOOD Corporation shall be free from any responsibilities for any defects and indemnities for any damages or losses. Selection and installation of any external equipment shall be done at your own risk. You are fully responsible for the use and effects of external equipment.
- JVC KENWOOD Corporation shall be free from any responsibilities for any incidental losses or damages, such as missing communications or call opportunities caused by a failure or performance error of the transceiver.
- Well aware in your mind, we cannot answer to any and all technical information associated with method of connection to, configuration for and operation of an external device and PC beyond our knowledge.

## TREATMENT OF YOUR IMPORTANT DATA

There is always a risk of losing your important data by a transceiver failure, occurrence of an unforeseen contingency, erroneous operation or faulty behavior of the transceiver. The data, such as the operating information, recorded audio, messages, configuration data, and logs, must be backed up as necessary by yourself and stored in an external storage device such as a USB flash drive.

## URL AND CONTACTS OF JVC KENWOOD CORP.

The latest URL and contacts of JVC KENWOOD Corporation at the time when this manual was written are described in this manual. Due to changes of social circumstances or the management environment, the URL and contacts of JVC KENWOOD Corporation may change from time to time.

# TABLE OF CONTENTS

## 01 PROLOGUE

About the Release of the TS-890S .....	1
Features of the TS-890S .....	2

## 02 RECEPTION CIRCUIT

Receiver Configuration .....	3
First Mixer .....	5
Roofing Filters.....	5
What is a Roofing Filter? .....	5
Roofing Filters .....	6
AGC Circuits .....	7
Analog AGC Circuits.....	7
Optimization Of Gain Distribution .....	8
Deflection of the S Meter Needle.....	8
Noise Level.....	9
RF Gain Adjustment .....	9
AGC Off.....	9
Noise Blankers.....	10
Features of the NB1 and NB2 .....	10
Auxiliary Circuits .....	11
Medium Wave Band Sensitivity Risers .....	11

## 03 TRANSMISSION CIRCUIT

IF Circuit for Clean and Stable 100 W Output Power .....	12
FET Final Amplifier Circuit .....	12
High-speed Relay-controlled Antenna Tuner.....	13
Linear Amplifier Control .....	14
REMOTE Connector .....	14
Linear Amplifier Menu Settings.....	15
ALC .....	17
Transmit Power Limiter .....	18
ALC Operation when an External Device is Connected.....	19
DRV Terminal .....	20
Protections.....	21
SWR Protection.....	21
Overcurrent Protection .....	21
Thermal Protection and Fan Control .....	21

## 04 LOCAL OSCILLATOR CIRCUIT

Local Oscillator .....	22
First Local Oscillator Signal .....	22

## 05 ANTENNA CONTROL CIRCUIT

Signaling Paths .....	24
RX Antenna Feature (RX IN / RX OUT Connectors).....	24
Antenna Output Feature (ANT OUT Connector).....	24
TS-890S User Report.....	25

## 06 MPU PERIPHERAL CIRCUIT

MPU Peripherals for Transceiver Control.....	28
MPU Peripherals for Application Control.....	28
MPU Peripherals for Operation Panel Control .....	28

## 07 DSP

Features of TS-890S DSP Technologies .....	29
DSPs and Peripheral Hardware .....	29
Signal Processing in the IF Stage .....	30
IF-AGC .....	30
AGC Quick Recovery .....	31
IF Filter .....	32
Interference Rejection .....	34
Reception .....	36
Demodulation .....	36
AF Filter.....	37
Audio Peak Filter .....	38
Noise Reduction.....	39
Beat Canceler.....	42
Signal Processing by Morse Code Decoder.....	43
Transmission.....	44
Modulation .....	44
Microphone Gain Control .....	46
Speech Processors .....	46
Other Functions .....	48
TX/RX Equalizers .....	48
Voice Guidance .....	48

## 08 BANDSCOPE

More User-friendly Bandscope .....	49
Differences with the TS-990S as an FFT Bandscope .....	49
3 Types of Scope Display Modes.....	49
Reference Level.....	50
Touchscreen Tuning.....	50
Gradation Settings.....	51
Tuning Assist Line, Filter Passband Display and Frequency Marker .....	51

## 09 SOFTWARE

Display Function for Actual Operation .....	52
Meter .....	52
Transmission Digital Meter .....	53
Filter Scope .....	53
Operability Improvements for Split Operation.....	54
Split Frequency Configuration By Using the Numeric Keypad.....	54
Band Direct Key Configuration for Split.....	54
Split Frequency Change By Using the RIT/XIT Knob.....	54
Split Frequency Reception By Using an External Sub Receiver.....	55

# TABLE OF CONTENTS

CW/RTTY/PSK Decoding/Encoding Available Only for the Main Unit .....	55
Decoding/Encoding of CW Morse Code.....	55
Decoding/Encoding of RTTY/PSK.....	56
Data Mode Convenient for Operation Using an External Device.....	57
Switching the Input Sound Source.....	57
USB Keying .....	58
Functions Related to the Internal Memory/USB Flash Drive/File Management.....	58
Selection of Data Storage Location .....	59
Storage and Reading of Configuration Data .....	59
Copying from the Internal Memory to the USB Flash Drive....	59
Copying from the Internal Memory to a PC.....	60
Configuring the Images to be Used in the Screen Saver .....	60
Other Useful Functions .....	61
Audio Scope.....	61
Recording Function .....	61
Clock Setting Function that uses an NTP Server .....	61
Transverse Dial Display in SWL Mode .....	62
Firmware Updating .....	62
PC-Control .....	63
KNS Operation without using the Host PC.....	65
Windows Software .....	66
System Configurations.....	67
New Option ARCP-890 (Radio Control Program for TS-890S) (Free Software Application).....	70
Basic Specifications Inherited from the ARCP-990.....	70
User Interface.....	70
New Option ARHP-890 (Radio Host Program) (Free Software Application).....	71
Basic Specifications Inherited from the ARHP-990.....	71
User Interface.....	71
ARUA-10 (USB Audio Controller) (Free Software Application).....	72
Basic Functions .....	72
Behavior .....	72
ARVP-10H/ARVP-10R (Radio VoIP Program) (Free Software Application).....	73
Basic Functions .....	73
Virtual COM Port Driver .....	74

## 10 TERMINAL FUNCTIONS

ACC 2 Connector.....	76
DISPLAY (DVI-I) Connector .....	77
EXT SP 8 Ω (External Speaker Jack).....	77
KEY PAD.....	77
LAN Connector .....	78
METER Jack.....	79
PADDLE, KEY Jack .....	79
PHONES Jack .....	79
USB Connector (USB-A) .....	80
USB Connector (USB-B) .....	81

## 11 MECHANICAL STRUCTURE

Internal Structure .....	82
Cooling .....	83
Lift-up Mechanism of the Front Bases.....	85
Operability .....	86
TFT Display and Touch Panel .....	88
Main Control Knob Mechanism.....	89

## 12 SP-890

Appearance and Features .....	90
Speaker .....	90
Built-in Passband Filter .....	91
Speaker Input Select Switch .....	91

## About the Release of the TS-890S

From the TS-590 that was released in 2010 to the TS-990S in 2013 and TS-590G in 2014, we have been releasing HF transceivers for Real DX'ers where efforts were devoted to the basic reception performance, and have received very high ratings for these products. In response to a strong demand for a grade that is positioned between the TS-990S and TS-590, we started considering the idea of commercializing the TS-800 series.

Previously, popular transceivers that were released under the TS-800 series include advanced, fully-armored units that can be used in the front line under demanding conditions such as DX contests.

Models such as the TS-820 (released in 1976: IF SHIFT, ARA processor), TS-830 (released in 1980: diverse interference elimination features), TS-850 (released in 1991: up-conversion) and TS-870 (released in 1995: first amateur transceiver with IF DSP) have played an active part with each of them equipped with the latest technology of the era. They are still employed by many of the users today.

The TS-890S, the latest addition to the glorious history of the TS-800 family, has been developed not only to complement the TS-990S and TS-590 series, but attention has also been devoted to the "basic reception performance", which is the main interest of our customers. As a benchmark, we have aimed to develop a design that offers top-class performance in 3rd Intermodulation Dynamic Range (3rd IMDR), as well as in Reciprocal Mixing Dynamic Range (RMDR) and Blocking Dynamic Range (BDR).

To achieve this, our initial plan when designing the receiving circuit configuration was to adopt the direct sampling system in line with the current trend. However, to enable users to make use of the unit without having to worry about the issue of overflow, we decided to adopt the down-conversion system that allows the use of narrow-band roofing filters. At the same time, we have also made significant enhancements to the C/N characteristics by developing a new first local oscillator circuit, which is another key element of superheterodyne down-conversion transceivers, based on the division type that was adopted on the TS-990S.

Doing so has allowed us to achieve the following values in the measurement: 3rd IMDR (110 dB), RMDR (122 dB), BDR (150 dB) (measurement when the frequency is 2 kHz detuned, receiving frequency of 14.2 MHz, MODE CW, BW 500 Hz, PRE AMP OFF).

For the IF DSP, which is protected by the impregnable front-end as suggested by these numerical values, we have developed an original AGC algorithm that enables demodulation of incoming signals using the KENWOOD tone that is non-tiring even during prolonged operation in contests. Listening to the tone is equivalent to the joy of receiving signals.

However, numerical performance is not the only criterion that determines whether a transceiver can be put into practical use. Elements related to user-friendliness, such as operability and visibility, are also important considerations.

The same 7-inch color TFT as with the TS-990S has been employed for the bandscope. Feedback from TS-990S users has been incorporated into a number of aspects. Some of such new features that come in handy particularly during contest operation include the auto scroll feature in the Fixed mode, straight display for waterfall in the Center mode, and highlight display for IF passband widths.

The bandscope receiver is configured using an SDR method that enables FFT processing of the entire display span, thus achieving signal processing at a faster speed compared to the TS-990S. At the same time, the bandscope receiver separately processes signals diverted from the first mixer for the incoming signal system, and this enables the use of ATT without affecting the incoming signals.

In terms of operability, we have exercised our ingenuity in the split-operation settings so as to maximize the operational efficiency during simplex reception via VFO A/B. These creative efforts allow configuration of the split settings using the long-press of the **[SPLIT]** key and the press of the numeric keypad, band change while retaining the split settings, and TX VFO operation using the **[RIT/XIT]** knob. Also, connection with an external receiver can be established easily using the ANT OUT feature. To use the TS-590 series as the external receiver, frequency transfer and standby are possible simply by connecting two cables.

As with TS-990S, the Digital mode comes with PSK/FSK decoding/encoding features and communication using the main unit alone is possible by connecting a USB keyboard. Not only so, TS-890S also comes with a decode/encode feature in the CW mode (only available in western languages). Morse codes can also be transmitted directly from the keyboard in the CW mode, which enables paddle-less operation.

The transmission output of 100 W is the same as the conventional TS-800 series models, but TS-890S allows for quiet and stable prolonged use with the employment of a large die-cast chassis and 80 mm x 80 mm twin fan system. Needless to say, the fans will not operate when only reception is in progress.

As described above, TS-890S has been developed to inherit the DNA of KENWOOD's HF transceivers and as a model that forms the core of the TS-x90 series. It is an advanced transceiver for practical use that has evolved in its own ways as a full-fledged successor of the TS-800 family, and not just a modified version of the TS-990S or TS-590 models.

This in-depth manual is written by the TS-890S designers to describe the technologies and techniques used to achieve the performance and features mentioned above. We hope it will help you gain an in-depth understanding of the TS-890S.

## Features of the TS-890S

- Advanced-level transceiver designed for practical use that surpasses the basic reception performance of models in the same class, boasts diverse features and inherits the texture of the TS-990S
- Adopts a 7-inch TFT color display and offers various information for an enhanced experience in the integrated management of operations: Auto Scroll mode, filter scope, TX digital meter, etc.
- Top-class basic reception performance - covers all frequency bands with the down-conversion system Comes equipped with 15 kHz, 6 kHz, 2.7 kHz and 500 Hz roofing filters (270 Hz roofing filter is available as an optional item)
- HF band, +50 MHz band, +70 MHz (European model only)
- 100 W heavy-duty output (50 W/70 MHz for European model)
- Built-in auto antenna tuner (relay system, high-speed matching)
- SSB, CW, FSK (RTTY), PSK31 (BPSK/QPSK), PSK63 (BPSK), AM, FM
- Enables decode/encode in FSK, PSK31/63 as well as CW mode
- Two 32-bit floating-point DSPs for transmission/reception and scope display
- Equipped with LAN, USB and COM ports
- Supports external connections (DVI-I terminal)
- Supports remote control operation that does not require the use of a host PC (direct IP connection) Radio control program (ARCP-890) and radio host program (ARHP-890) are supplied as free software as with previous models
- Supports USB audio PC speakers and microphone can be used for operation by employing the USB Audio Controller (ARUA-10) free software
- SP-890 (external speaker) and YG-82CN-1 (270 Hz CW filter) are available as optional items

# 02 RECEPTION CIRCUIT

## Receiver Configuration

The TS-890S is the single-band transmitter-receiver of the down-conversion method, which is refined and diverted from the circuit configuration of the main band receiver of the top-model TS-990S. During transmission, the receiver behavior stops. Also, the bandscope circuit shows the status of IF signals during reception and transmission.

It is important for a receiver to eliminate interfering signals through narrow filters at an earlier stage and pass desired signals to the later circuits. In addition to the RF bandpass filter placed in the front-end block of the receiver, eliminating the adjacent interfering signals by using the IF bandpass filters with better selection characteristics prevents distortion from occurring in the later circuits and improves practical anti-interference characteristics. The first mixer, through which a number of interfering signals pass, needs to have high intercept point (hereinafter referred to as IP) characteristics.

The down-conversion method where the first IF signal is 8.248 MHz is adopted. The use of a low IF signal realizes the bandpass filters with steep attenuation characteristics, and performance sufficiently tolerant to adjacent interfering signals is secured.

Next is the bandpass filters placed in the front-end block. The use of a low first IF signal allows reception interference and/or spurious reception by image frequencies to easily take place, thus it is necessary to place a number of bandpass filters with steeper attenuation characteristics. As shown in the table “Bandpass Filter Division in the Receiver”, the bandpass filters divided into multiple paths are designed to implement the high Q value and a coil with distortion resistance characteristics.

Table 1 Bandpass Filter Division in the Main Band Receiver

Band	Filter Bandwidth
135 k	30 k to 521.999 kHz
BC	522 k to 1.704 999 MHz
1.8 M	1.705 M to 2.499 999 MHz
3.5 M	2.5 M to 4.099 999 MHz
5 M	4.1 M to 5.999 999 MHz
7 M	6.0 M to 7.499 999 MHz
10 M	7.5 M to 10.499 999 MHz
14 M	10.5 M to 14.499 999 MHz
18 M	14.5 M to 18.499 999 MHz
21 M	18.5 M to 22.499 999 MHz
24 M	22.5 M to 27.499 999 MHz
28 M	27.5 M to 34.999 999 MHz
35 M	35.0 M to 41.499 999 MHz
45 M	41.5 M to 47.999 999 MHz
50 M	48.0 M to 54.999 999 MHz
60 M	55.0 M to 59.999 999 MHz
60 M*	60.0 M to 61.999 999 MHz
65 M*	62.0 M to 68.999 999 MHz
70 M*	69.0 M to 74.799 999 MHz

\*European model only

## 02 RECEPTION CIRCUIT

The received signal which was input from the antenna comes into the front-end block of the receiver through the antenna switching circuit. The bandpass filter for the selected receive band eliminates interfering signals outside the band. The received signal is amplified by a pre-amplifier and is then converted to the first IF signal (8.248 MHz) by the first H-mode mixer having high IP characteristics.

The “Block Diagram of the Front-end Circuit for the Receiver” is shown below:

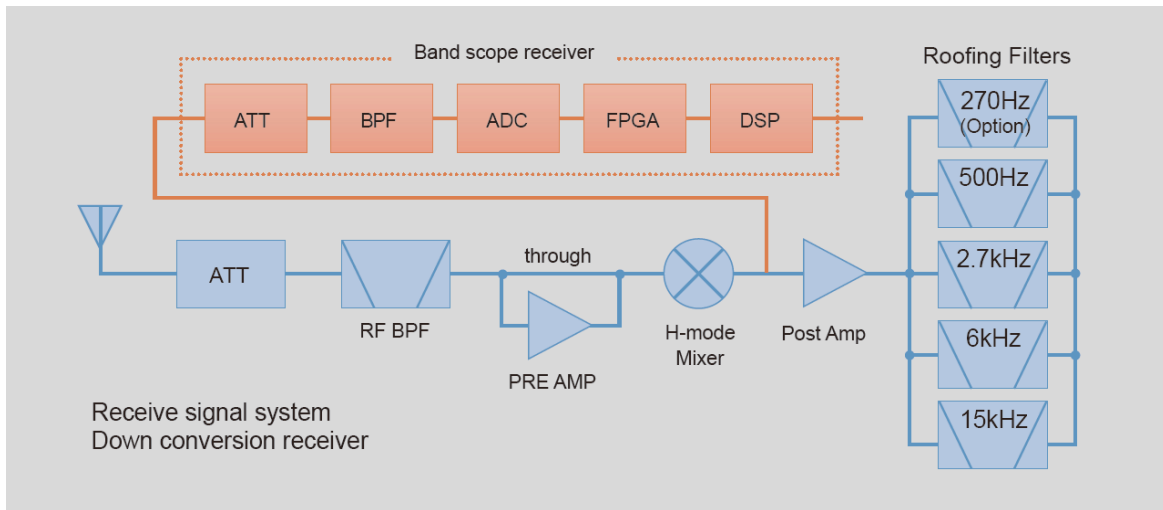

Fig. 1 Block Diagram of the Front-end Circuit for the Receiver

The first IF signal enters the roofing filter through the bandscope branching circuit and the post-amplifier, and the adjacent interfering signals outside the band is eliminated.

The “Block Diagram of the IF Circuit for the Receiver” shown below shows the circuit configuration subsequent to the roofing filters. The first IF signal routes through the AGC amplifier and the first IF amplifier to the second mixer, which converts it to the second IF signal (24 kHz/36 kHz). The second IF signal enters the DSP as the baseband signal through the second IF amplifier, and the AGC response, all-mode demodulation, and audio signal processing, etc. are done.

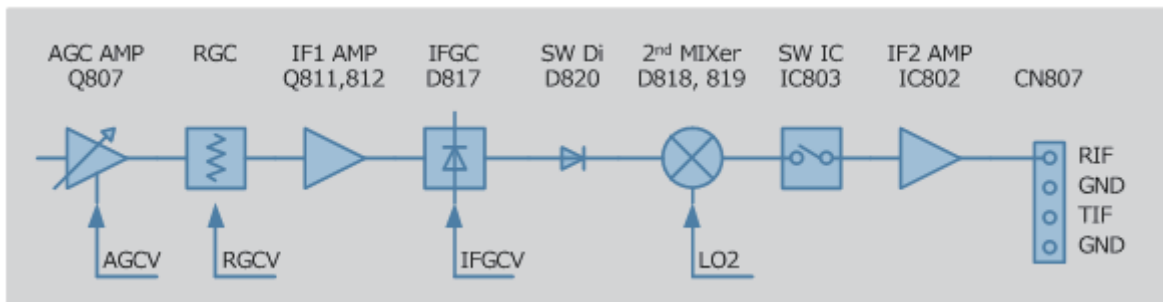

Fig. 2 Block Diagram of the IF Circuit for the Receiver



## First Mixer

For the first mixer, the “H-mode mixer” with less distortion is refined and diverted from the one adapted in the TS-990S main receiver, and the conversion loss has been reduced and matching of the frequency characteristics of the mixer input port by the wide bandwidth is enabled.

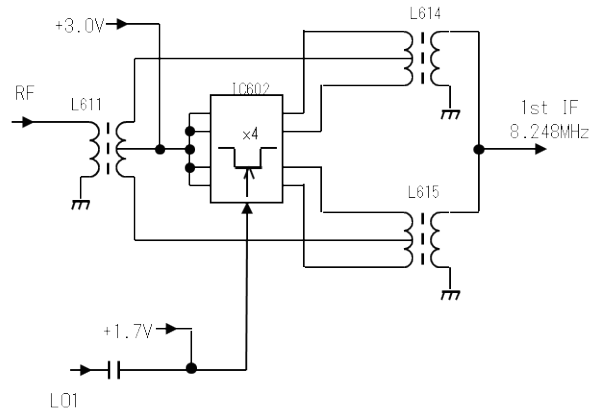

Fig. 3 First Mixer Circuit

## Roofing Filters

### What is a Roofing Filter?

This section describes the roofing filter, which is the most important in the receiver. The roofing filter is a filter placed at the ceiling, or the “roof” of the intermediate frequency (IF) circuit of the receiver. In other words, this represents a narrowband filter where the signal converted to the intermediate frequency first passes through. The received signals include a number of strong adjacent interfering signals other than the desired signal, thus by the attenuated amount outside the band of the filter, the signal is less likely to be distorted in the subsequent amplifying circuit. The high intercept point obtained by the high-performance first mixer gives full play to its ability in a frequency domain slightly distant from the desired signal, which is attenuated by the roofing filter. This is why the roofing filters have been narrowed to their minimum and have been attenuated to the steepest direction.

## Roofing Filters

Four types of roofing filters are equipped as standard as narrowband filters of high IP characteristics implemented by the full down-conversion method. In addition, to meet the needs for narrower band filters, optional filters are available (sold separately) and supported by a mounting slot. The “Photograph of Roofing Filters” is shown below:

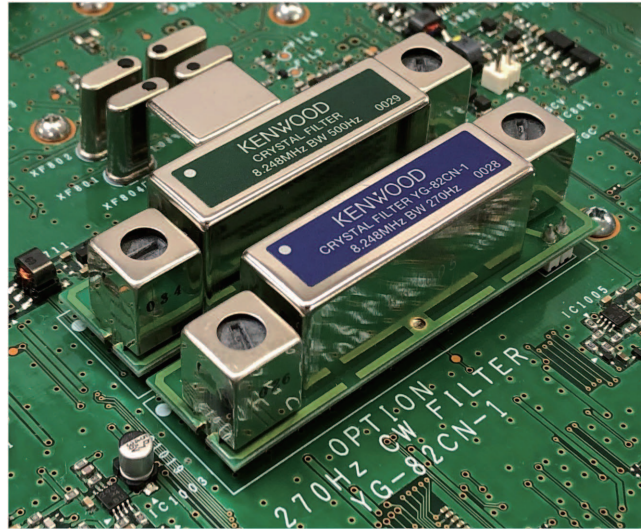

Fig. 4 Photograph of the Roofing Filters

The filters of the 15 kHz, 6 kHz, 2.7 kHz, and 500 Hz (270 Hz) bandwidth are mounted from the top in the photograph. The filters of the 15 kHz and 6 kHz bandwidth are the 4-pole monolithic crystal filters (hereinafter referred to as MCF), and the filter of the 2.7 kHz bandwidth is the 6-pole MCF. The filter of the 500 Hz bandwidth is structured as the ladder type to suppress in-band insertion losses and to steeply shape the adjacent out-of-band attenuation characteristics. The ladder filter of the 270 Hz bandwidth, which is the much narrower band, is also available as an optional filter. For each ladder filter frequency response, the “Frequency Response of the 500 Hz Bandwidth” and “Frequency Response of the 270 Hz Bandwidth” are shown below:

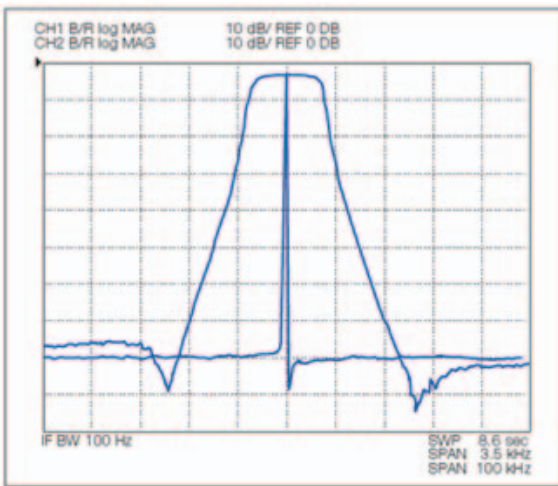

Fig. 5 Frequency response of the 500 Hz Bandwidth

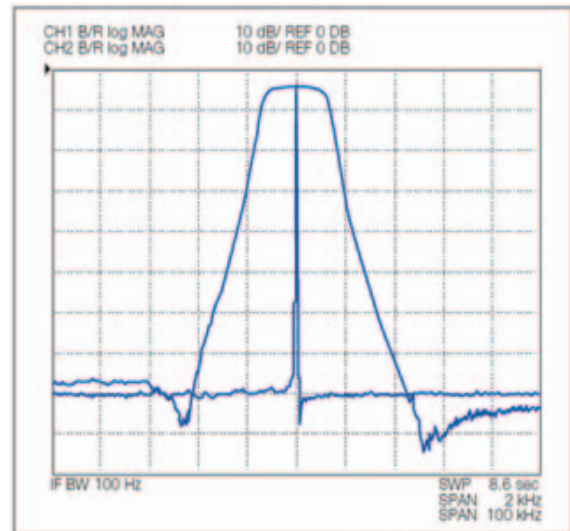

Fig. 6 Frequency response of the 270 Hz Bandwidth (Option)

The roofing filters for the receiver can be selected regardless of the operation mode.

In the RX Filter screen which appears on the display by pressing and holding the **[IF FIL]** key, switching to the roofing filter corresponding to the passband width can be used for the reduction of the interference signal.

## AGC Circuits

### Analog AGC Circuits

To achieve high receive dynamic range characteristics, an analog AGC circuit is used together to make the A/D converter work to its performance limit. The AGC circuit is required to have low noise and a wide dynamic range, wide control range, and linearity to the control. The TS-890S implements high-precision AGC response characteristics with the combination of an AGC circuit in which a dual-gate MOSFET is used and the correction process made by DSP. The “AGC Circuit with a Dual-Gate MOSFET” is shown below:

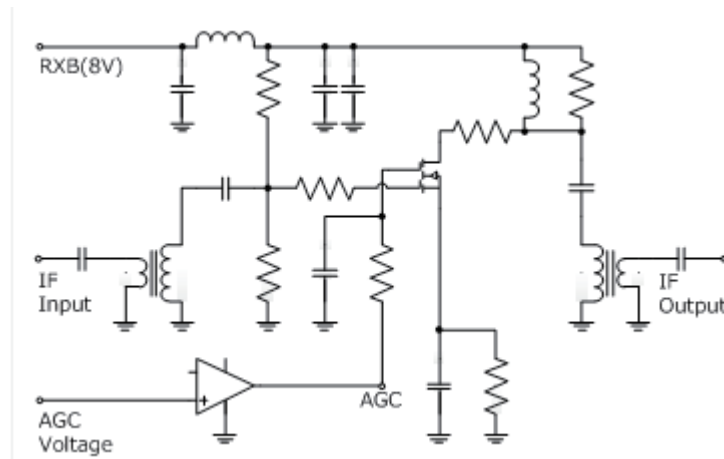

Fig. 7 AGC Circuit with a Dual-Gate MOSFET

The “AGC Response Characteristics to a Control Voltage” graph below shows the AGC response characteristics to a control voltage in the circuit configuration with a dual-gate MOSFET. Sufficient control range, dynamic range, and linearity are secured.

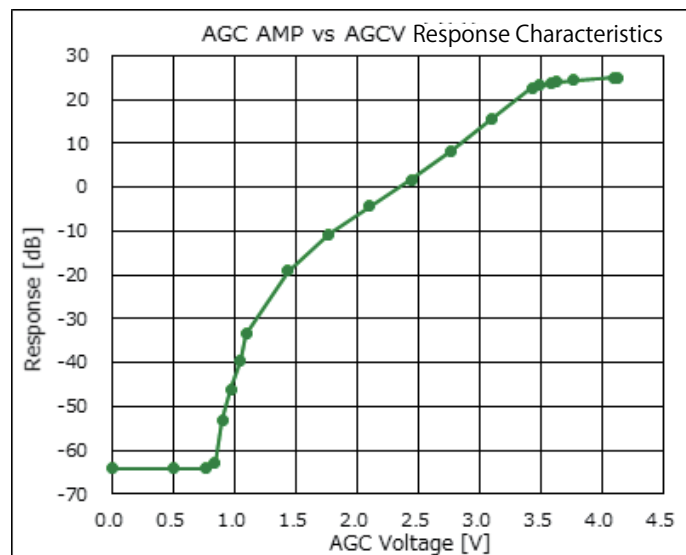

Fig. 8 AGC Response Characteristics to a Control Voltage

## Optimization Of Gain Distribution

The first mixer, which is the key block in the receiver, has a large conversion loss. Therefore, a pre-amplifier to improve sensitivity is placed.

Pre-amplifier 1 is the standard behavior in a reception band below 21.5 MHz, and pre-amplifier 2 is the standard behavior in a reception band of 21.5 MHz or larger, and depending on the radio wave status, OFF / PRE1 / PRE2 can be switched by pressing the [ANT/PRE] key.

The attenuation outside the band is fully obtained by the roofing filters with good selectivity, thus even through the analog AGC amplifier and high-gain IF amplifier in a later stage, undistorted IF signals are supplied as baseband signals to the DSP.

## Deflection of the S Meter Needle

The IARU (International Amateur Radio Union) standard scale requires -73 dBm for S9. However, concerning the S meter needle deflection, on all of the KENWOOD transceivers, it is -81 dBm for S9 in the 14 MHz band while a pre-amplifier is on. The TS-890S also provides the S meter needle deflection familiar to operators using a conventional model.

Turning off the pre-amplifiers lowers the gain and the S meter needle deflection. For the gain change by a pre-amplifier, approximately +12 dB is the standard configuration in the amateur bands up to the 21 MHz band and approximately +20 dB in the higher bands.

The “S Meter Levels” table shows the indicated levels of the S meter. (The S meter level is managed at S1, S9, or S9+60 dB in the 14 M /50 MHz band.)

In FM mode, the same deflection (Normal) as that in other mode is the default, and you can select the same high sensitivity (High) as that configured for conventional models through Menu 0-07 “FM Mode S-meter Sensitivity”

Table 2 S Meter Levels (Reference)

S-meter 表示		0.03 M ~ 21.5 MHz		21.5 M ~ 60 MHz ( ~ 74.8 MHz*) *European model only		
		PREAMP 1		PREAMP 2		
		All Mode		All Mode, FM Normal		FM High
		Type 1	Type 2	Type 1	Type 2	Type 1
S1	3 dot	-107.0 dBm	-121.0 dBm	-114.0 dBm	-141.0 dBm	-116.0 dBm
S3	11 dot	-100.5 dBm	-109.0 dBm	-107.5 dBm	-129.0 dBm	-113.8 dBm
S5	19 dot	-94.0 dBm	-97.0 dBm	-101.0 dBm	-117.0 dBm	-111.3 dBm
S7	27 dot	-87.5 dBm	-85.0 dBm	-94.5 dBm	-105.0 dBm	-108.7 dBm
S9	35 dot	-81.0 dBm	-73.0 dBm	-88.0 dBm	-93.0 dBm	-106.2 dBm
S9+20	48 dot	-61.0 dBm	-53.0 dBm	-68.0 dBm	-73.0 dBm	-102.0 dBm
S9+40	59 dot	-41.0 dBm	-33.0 dBm	-48.0 dBm	-53.0 dBm	-98.5 dBm
S9+60	70 dot	-21.0 dBm	-13.0 dBm	-28.0 dBm	-33.0 dBm	-95.0 dBm

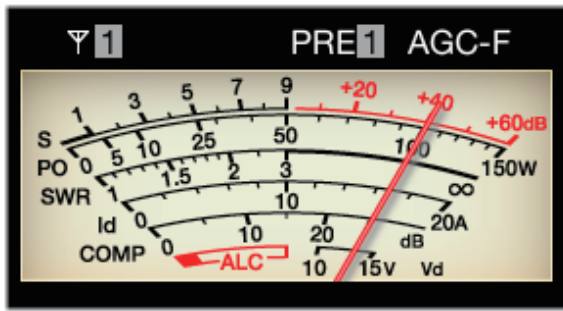

Fig. 9 S Meter Readout (Analog)

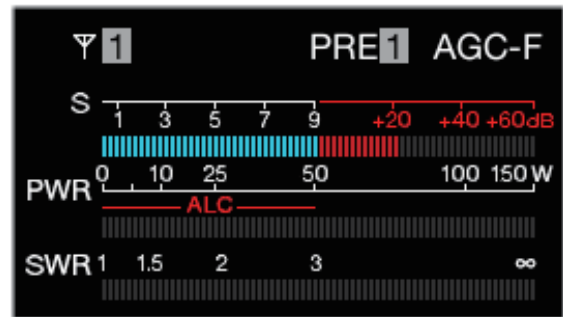

Fig. 10 S Meter Readout (Digital)

## Noise Level

Because a pre-amplifier has a gain, not only does the sensitivity increase with the pre-amplifier active, but the noise level rises, and the S meter needle is easily deflected. The sensitivity decreases with the pre-amplifier inactive; however, the IP characteristics improve, noise level lowers, and the S meter needle is also less likely to be deflected. In addition, the IF gain is corrected to be lowered when the pre-amplifier is turned on so that the gain, sensitivity, deflection of the S meter needle, noise level, and other factors appropriately change.

## RF Gain Adjustment

KENWOOD HF-band transceivers are configured with our consistent philosophy to balance the levels, such as the sensitivity, S meter needle deflection, pre-amplifier gain, gain correction, and other factors, thus the internal noise may be conspicuous if the input level from an antenna is low. Reducing the IF gain can lower the noise level. For that purpose, the [RF] knob is provided. Rotating the [RF] knob counterclockwise reduces the IF gain and consequently lowers the noise level. Slightly lowering the gain does not change the reception sensitivity. The S meter shows the gain reduction by the AGC and the [RF] knob, thus the S meter needle deflects by the gain reduction. In the range the AGC is applicable, the S meter sensitivity does not change.

Placing the [RF] knob to the 3 o'clock position reduces the IF gain by approximately 6 dB from the maximum and reduces the noise level at no signal by approximately 6 dB. The gain reduction causes the S meter needle to deflect closer to S3. A 6 dB gain reduction causes the sensitivity to change little, and the reception sound volume does not change even with reception of a usual signal that makes the S meter needle deflect. If the noise level is noticeable, adjust the RF gain. (The S/N sensitivity does not lower until the [RF] knob is in the 12 o'clock position even when the pre-amplifier is inactive.)

## AGC Off

The AGC time constants for such as the attack time, release time, and hold time are optimized for a practical radio waves state. However, for reception of a signal easily buried in noise, turning the AGC off may occasionally increase its performance. In such a case, the AGC can be disabled according to the settings screen to which the screen is switched with a long press of the [AGC] key.

With the AGC inactive, the signal level will not be controlled to be the certain volume level, and the speaker may emit very loud sounds. This is why a confirmation message appears before the AGC is turned off to prompt attention to loud sounds.

Before turning the AGC off, you must adjust the RF gain. For the signal of the S meter deflection level, rotate the [RF] knob counterclockwise to lower the RF gain level, letting the S meter needle deflect slightly wider. This prevents loud sounds from being emitted while the AGC is inactive.

If a large signal is entered while the AGC is inactive, the S meter needle deflects up to the level specified for the RF gain and the reception sound volume increases up to a certain level. However, if this level is exceeded, the reception audio volume reaches its limit and sudden distortion takes place. This is intended to set limits so that the allowable levels are not exceeded in the D/A converter and through signal processing.

## Noise Blankers

### Features of the NB1 and NB2

The TS-890S has two noise blankers; NB1 for analog processing and NB2 for digital processing by DSP.

NB1 is effective for short-cycle pulses, such as ignition noise. NB2 is effective for noise that the analog noise blanker (NB1) cannot follow. The diagram “Noise Blanker Circuit (NB1) Block Diagram” is the block diagram of the analog noise blanker (NB1).

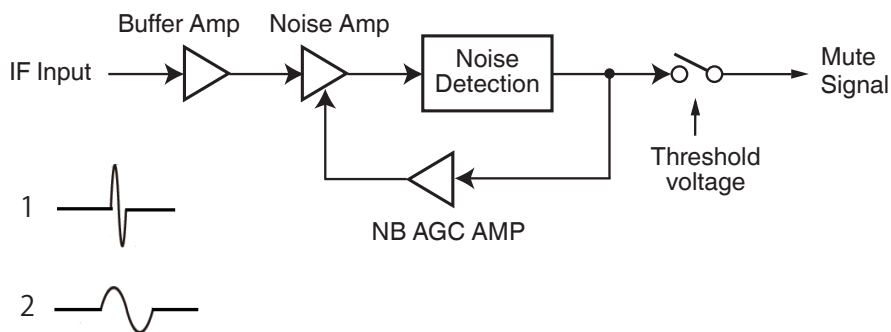

Fig. 11 Noise Blanker Circuit (NB1) Block Diagram

NB1 has the circuit configuration inherited from that of conventional models, which is effective for weak noise. A pulse signal after passing through a narrowband filter changes its noise waveform, increasing the pulse width. Thus, at the roofing filter input stage, which is not subject to influence of pulse noise, signals are picked up and switch circuits operate.

For example, if a pulse with a short cycle is entered as shown in diagram 1, the AGC in the noise blanker circuit does not react to it, thus the switch functions and a muted signal will be present.

To the contrary, if a pulse with a long cycle is entered as shown in diagram 2, the AGC reacts to it and corrects the gain, thus the switch does not function and the signal will not be muted.

The adjustment of the NB1 effect can be adjusted by the value displayed on the setting screen by a long press of the **[NB1]** key. The larger the value, the larger the effect on noise.

As described above, the noise blanker may insufficiently take effect if the roofing filter bandwidth is narrow. However, the DSP digital noise blanker (NB2) may be unexpectedly effective in CW mode even in a bandwidth of 500 Hz or lower. This is because NB2 operates flexibly, conforming the blanking time to the pulse length.

NB2 produces an effect on the acquisition of a weak desired signal that is buried in the noise with a long pulse width that NB1 cannot eliminate. Chapter 6 DSP describes the details of NB2.

### ● How to Use the NBs and NRs

There is a term: “NB cross-modulation”. This means the state in which a noise blanker is behaving with the desired signal or adjacent signal falsely recognized as a noise pulse. It does not relate to the front-end performance.

There are 2 states: the noise of non-desired signals clearly appears (or noise clearly appears according to the keying in CW), or the desired signal is heard with distortion.

The former case is caused by the noise blanker being unable to produce an effect when the desired signal is relatively strong, or when a strong signal appears in an adjacent frequency. This is because a strong signal activates the AGC of the noise blanker so that the noise amplifier gain decreases. If the level of the signal and the level of the pulse noise are equivalent, placing an attenuator or disabling the pre-amplifier decreases the front-end gain and may restore the effect of the noise blanker.

The latter case may easily take place by increasing the noise blanker level. This is a trade-off and is inevitable. If the received signal appears to be distorted, turn off the noise blanker and check the received sound. If doing so takes effect, then turning on the noise blanker and adjusting the noise blanker level is recommended.

## Auxiliary Circuits

### Medium Wave Band Sensitivity Risers

Just as in past transceivers, the TS-890S has attenuators of approximately 20 dB for the medium wave band (522 kHz to 1.705 MHz) (as the factory default, the sensitivity is lowered by approximately 20 dB by the attenuators). In the medium wave band, there are a number of strong radio waves and there may be medium wave band signal input that is excessive for low-band antennas. The inserted attenuators are intended for clear reception with no distortion even if such strong medium wave band signals are received. The signal can bypass the attenuator after switching the jumper pins on the board so as to allow the sensitivity to increase.

The image “Jumper Pin Locations” is the image of the TX-RX unit board with the main band attenuator jumper pins placed. Detach the TS-890S lower case to access the TX-RX unit. (Before detaching the lower case, be sure to first detach the upper case. There is the danger of the cases being damaged.)

Table 3 Medium Wave Band ATTs

NORM (ATT: 20 dB)	DX:Thru
CN 302	CN 301

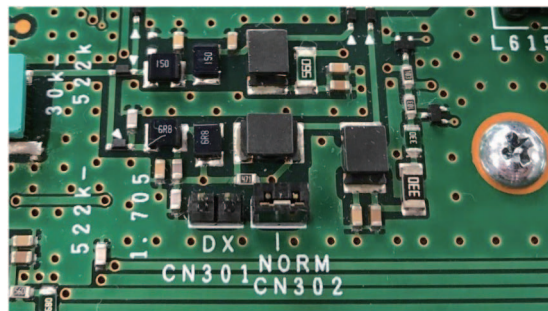

Fig. 12 Jumper Pin Locations

The jumper pins are placed in the “NORM” position at shipment. Switching the jumper pins to “DX” bypasses the attenuators and raises the medium wave band sensitivity by approximately 20 dB.

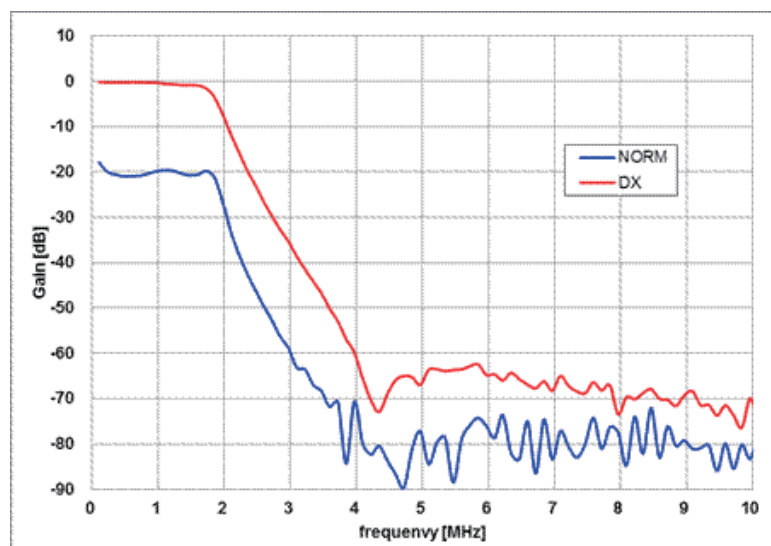

Fig. 13 Medium Wave Bandpass Filter Characteristics

## 03 TRANSMISSION CIRCUIT

### IF Circuit for Clean and Stable 100 W Output Power

A signal modulated and multifariously processed in the DSP is fed as the 24 kHz (modes other than FM) or 36 kHz (FM mode) transmit first IF signal by a D/A converter, which is then converted by a diode mixer used for both transmission and reception to 8.248 MHz. The second IF signal of 8.248 MHz passes through an IF filter with a 6 kHz (modes other than FM) or 15 kHz (FM mode) bandwidth at which undesired frequency components outside the band are attenuated, after which it is being amplified.

Next, the signal goes through a gain control circuit that corrects the gain difference by band, enters the mixer IC, and is then converted to a 71.752 MHz or 41.752 MHz (European model 70 MHz band only) third IF signal. After that, the signal passes through a gain control circuit that corrects the signal gain to the required level for the specified transmit power. The signal then passes through a filter that eliminates unwanted spurious components and an ALC circuit that controls the signal for stable transmit output, and enters a mixer circuit for conversion to the desired transmit frequency. Also, fine gain control is performed according to the situation, such as lowering the amplifier gain when there is no key-down during operation in the CW mode. Processing in this way enables low-noise and high-quality transmit signals to be obtained.

The signal converted to the desired transmit frequency passes through a bandpass filter to eliminate spurious signals, so as not to generate an interfering signal outside the transmit bandwidth, and is amplified to a certain level and sent to the final circuit. The drive signal generated through the process is also available from the DRV terminal (if the DRV output is enabled).

### FET Final Amplifier Circuit

The final amplifier uses two MOS FET RD100HHF1 (Pch 176.5 W) manufactured by Mitsubishi and is configured with a push-pull system. Meanwhile, MOS FET RD16HHF1 is employed for the drive amplifier and MOS FET RD06HHF1 for the pre-drive amplifier. Optimization of matching is performed to achieve a 13.8 V final circuit with low-distortion signal.

Coupled with heat dissipation by the large die-cast, stable continuous operation can be achieved.

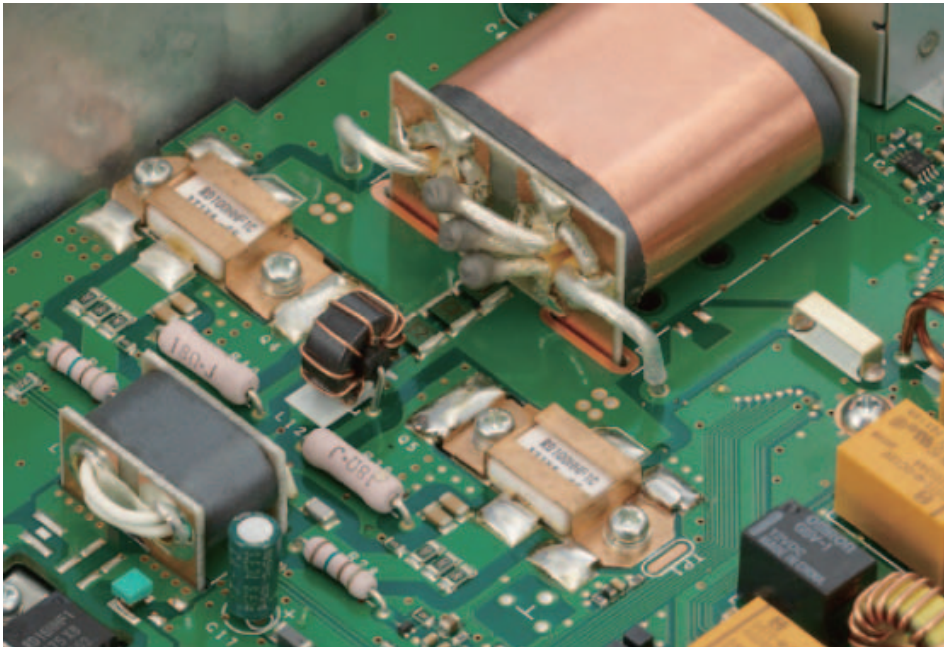



The “Transmit IMD Characteristics (14.2 MHz, 100 W output power)” and “Transmit Spurious Response (14.2 MHz, 100 W output power)” graphs show the IMD characteristics and harmonic spurious response. The graphs prove superb anti-distortion characteristics and clean output power.

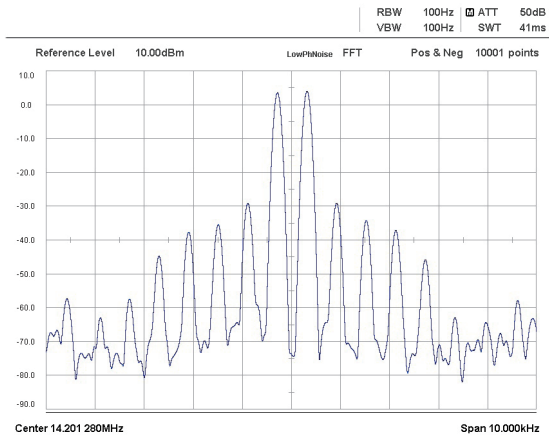

Fig. 14 Transmit IMD Characteristics (14.2 MHz, 100 W output power)

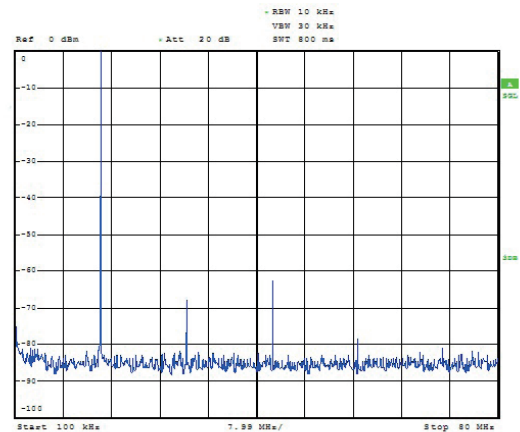
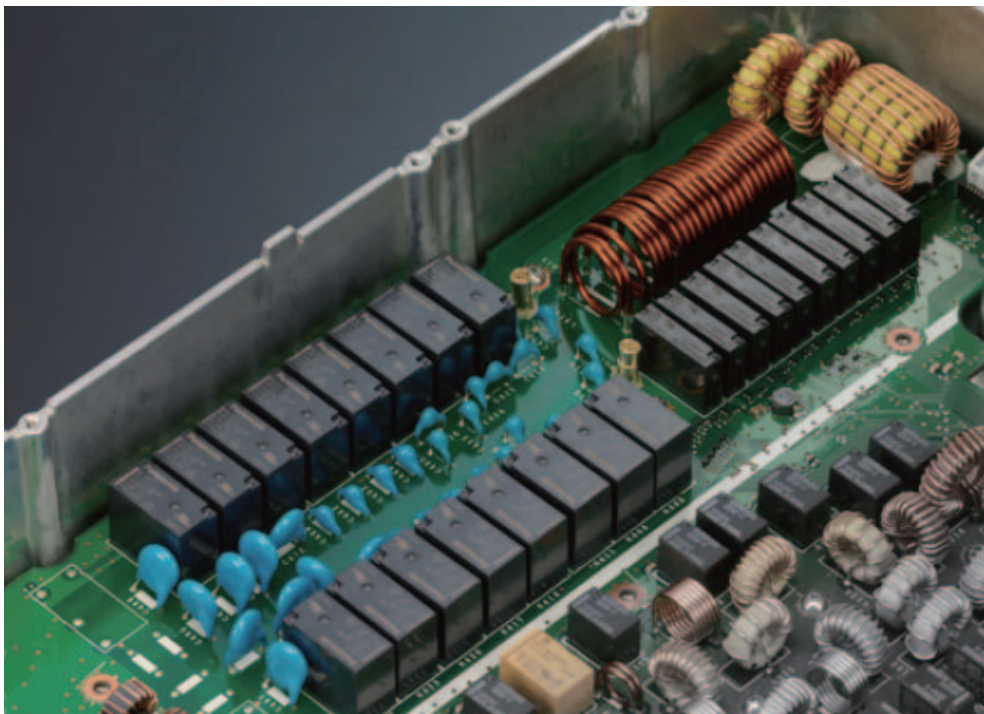

Fig. 15 Transmit Spurious Response (14.2 MHz, 100 W output power)

## High-speed Relay-controlled Antenna Tuner

The TS-890S has a high-speed relay-controlled antenna tuner, which digitally controls in a combination of capacitors of different capacitance through switching relays. The digital control achieves high-speed tuning.



# Linear Amplifier Control

Linear amplifier control can be used for switching between transmission and reception of devices such as the linear amplifier and transverter.

## REMOTE Connector

The REMOTE connector is a 7-pin DIN type connector, the same as our conventional transceivers.

The **LKY** (Linear amplifier Keying) terminal (pin 7) is equipped with a logic to output 12 V on transmission and a logic for short-circuiting to ground on transmission according to the linear amplifier menu setting which will be described later.

The “REMOTE Connector Pin Assignment” illustration shows the signaling paths allocated to the REMOTE connector pins.

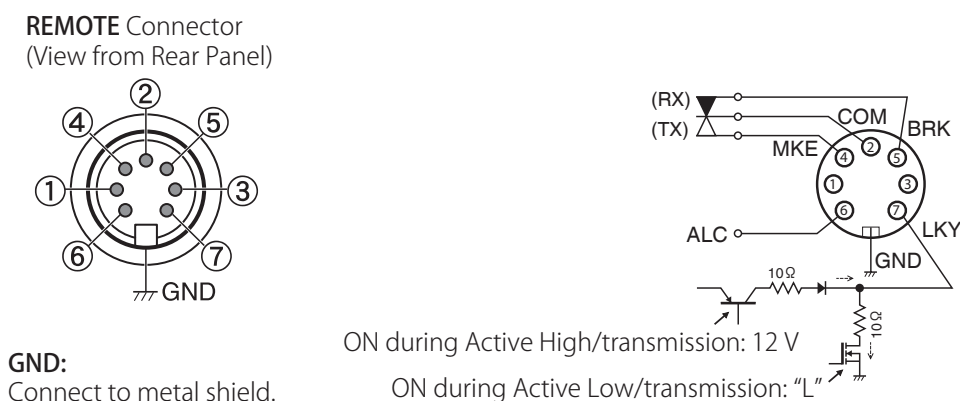

Fig. 16 REMOTE Connector Pin Assignment

Table 4 Terminal Descriptions for the REMOTE Connector

Terminal No.	Terminal Name	Function	Input/Output
1	SPO	Speaker out	O
2	COM	Common terminal of the built-in relay for linear amplifier control	I/O
3	SS	PTT input • Sends signal by grounding the SS terminal.	I
4	MKE	Make terminal of the built-in relay for linear amplifier control • The make terminal can be connected to the common terminal during transmission by configuring “ Internal Relay Control ” of the linear amplifier menu. Rated control capacity of relay contact: 2 A/ 30 V DC (resistance load) Maximum allowable voltage of relay contact: 220 V DC, 250 V AC	I/O
5	BRK	Break terminal of the built-in relay for linear amplifier control • The break terminal can be connected with the common terminal when the latter is not connected to a make terminal. Rated control capacity of relay contact: 2 A/ 30 V DC (resistance load) Maximum allowable voltage of relay contact: 220 V DC, 250 V AC	I/O
6	ALC	ALC input from the linear amplifier • This is a negative input. The ALC circuit starts to operate from an input of approximately -4 V (which can be changed from the Linear Amplifier menu).	I

Terminal No.	Terminal Name	Function	Input/Output
7	LKY	Linear amplifier control output <ul style="list-style-type: none"> <li>The output logic during transmission can be configured using "Keying Logic" (16-14) of the linear amplifier menu.</li> </ul> "Active High" : Outputs DC 12 V during transmission. The maximum output current is 100 mA. "Active Low" : Switches to the "L" level (GND and short) during transmission. When an external bias is applied while receiving is in progress, the signal switches to the "H" level. Voltage and current not higher than DC 50 V and 100 mA respectively can be controlled.	O

The TS-890S linear amplifier control relay functions on transmission if "Internal Relay Control" is enabled in the Linear Amplifier Menu.

The linear amplifier control relay assumes that the TL-922 (discontinued) is standing by and can be connected as-is to the TL-922. For a linear amplifier that stands by with a voltage application or a short-circuit to ground, disable the relay control and make it stand by using the **LKY** terminal as described later.

When transmission starts while the **LKY** terminal is set to "Active High", the transistor switch is turned On as shown in the illustration and 12 V is diverted (100 mA or less). Active High indicates that the logic is high while the circuit is active. After connecting a linear amplifier that switches the transmission operation upon detecting a voltage output, set the **LKY** terminal to "Active High".

When transmission starts while "Active Low" has been configured for the **LKY** terminal, the FET switch is turned On as shown in the illustration and short-circuits to ground. Active Low indicates that the logic is low while the circuit is active.

The linear amplifier type that can be connected is one that switches to the transmit state while the signal pulled up by the linear amplifier is being short-circuited to ground. When such a linear amplifier is connected, configure "Active Low" for the LKY terminal. However, the amount of withstand voltage and current are not large (DC 50 V or less, 100 mA or less), thus it is not possible to drive a relay in this circuit or connect those which are activated with high voltage, such as some of the evacuated-tube type linear amplifiers (e.g., TL-922). In such a case, use relay contacts alternatively.

## Linear Amplifier Menu Settings

The Linear Amplifier Menu is used for configuring features related to the linear amplifier. The settings are configured separately according to the band, including HF Band, 50 MHz Band and 70 MHz Band (European model only). Below are descriptions of the configurable items.

### ● Linear Amplifier

Configuring to On enables the respective functions of the Linear Amplifier Menu, while the settings will not be applied when Off is selected.

### ● Keying Logic

For configuring the logic for linear amplifier transmission control.

Configuring to "Active High" outputs +12V during transmission.

Configuring to "Active Low" short-circuits to GND during transmission.

### ● Tx Delay Time

Extends the duration from when the transceiver is placed in the transmit state until radio waves are output and also the duration until audio is output after returning to reception.

Large-sized relays generally tend to take time to start switching after energizing and have a long duration of time in which chattering may take place at the moment of switching. If transmission starts before the contacts switch to the transmission side, the SWR will increase until the switching finishes, thus the TS-890S activates a protection circuit to momentarily reduce the transmit power. There is also another case where contact switching to the reception side after reception starts may cause a strong clicking noise. Configuring Tx Delay Time may help to prevent such problems.

● Tx Delay Time (CW/FSK/PSK)

For configuring the delay time that is enabled when in the CW/ FSK/PSK non-audio mode.

● Tx Delay Time (SSB/FM/AM)

For configuring the delay time that is enabled when in the SSB/FM/AM audio mode.

This can be configured to a setting that is different from that for the non-audio modes.

When PTT is pressed, the sound that is emitted from the PTT switch as well as the operating sound of linear amplifier relay switching may sometimes be picked up by the microphone and transmitted. In such a case, the delay time can be configured to a longer duration to prevent output of unwanted radio wave transmissions.

● Internal Relay Control

For configuring whether to activate the built-in linear amplifier control relay.

The rated control capacity of the relay contact is 2 A/30 V DC (resistance load) and the maximum allowable voltage is 220 V DC and 250 V AC. It can be used to switch high-voltage signals such as those of a vacuum tube linear amplifier. Control of the TL-922 (terminal voltage: -140 V) is possible.

● External ALC Voltage

For use with a linear amplifier or transverter, it is possible to connect an external device to the ALC terminal (pin 6) to enable proper transmit power control.

The External ALC Voltage can be configured to -1, -2, -3, -4 (default setting), -5, -6, -7, -8, -9 or -10 (V), and the internal gain starts to decrease upon roughly reaching the preconfigured voltage.

When the linear amplifier that is being connected supports full break-in and is placed in the transmitting state when a voltage of +12 V is applied, configure “Keying Logic” to “Active High” and “Internal Relay Control” to “Off”.

If the external linear amplifier that is being connected does not support full break-in and takes time to switch the internal relay contacts, such as the TS-922, configure to “Tx Delay Time (CW/FSK/PSK)” or “Tx Delay Time (SSB/FM/AM)” in the linear amplifier menu. This configuration extends the duration of time from when the transceiver is placed in the transmit state until radio waves are practically transmitted so that the linear amplifier relaying will switch and then transmit the radio waves. If full break-in is active in CW mode, the duration of time prior to a transmission is not extended.

Note that configuring to “Tx Delay Time (CW/FSK/PSK)” or “Tx Delay Time (SSB/FM/AM)” extends not only the duration of time until a transmission starts but also the duration of time until reception begins, and this helps to reduce the click noise at the moment of switching to reception.



Fig. 17 Linear Amplifier Control Settings Menu Screen

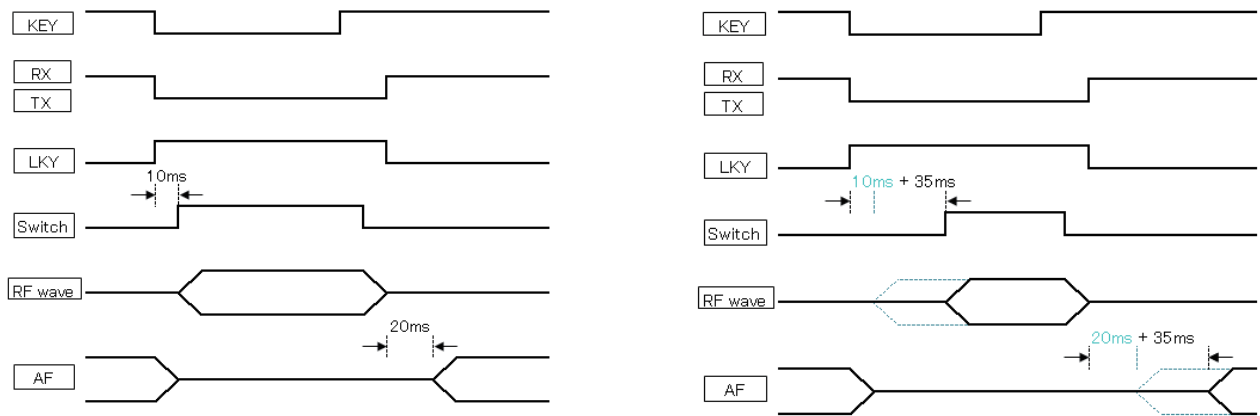

Fig. 18 Tx Delay OFF Selected (Left) and 35 ms Selected (Right)

## ALC

For use with a linear amplifier or transverter, it is possible to connect an external device to the **ALC** terminal (pin 6) to enable proper transmit power control.

The ALC signal is a signal output from an external device that shifts the voltage to the negative side (for KENWOOD transceivers) when the transmit power reaches the range to be restricted from the external device standpoint. External devices generally have voltage adjustment VRs (variable resistors). On the TS-890S, applying a negative voltage to the ALC terminal reduces the internal gain. The operating point is described later.

As described above, the conventional method of control is by inputting ALC signals from the linear amplifier. However, this method is no longer recommended on recent transceivers. This is because excessive power is applied to the linear amplifier before ALC voltage is input from the it, and this may cause damage to the linear amplifier. Also, the protection circuit inside the linear amplifier may be activated. To prevent such excessive input, adjust the transmit power to a proper level in advance.

### ● Recommended Operation

On the TS-890S, configure the maximum transmit power that can be input to the linear amplifier in advance. The ALC control in the transceiver activates at high-speed, thus it can limit the output power without receiving an ALC signal from the linear amplifier. The transmit power limiter described later is useful for this.

After the abovementioned setting is complete, apply the ALC signal of the linear amplifier to the **ALC** terminal of this unit. Doing so protects the linear amplifier when it has to limit the transmit power, or in cases such as when the transmit power of the TS-890S is increased by mistake.

## Transmit Power Limiter

The transmit power limiter prevents the transmit power from exceeding the pre-configured transmit power level. It can be turned on or off by pressing the **F [MAX-Po]** key. The power limit can be configured for each band as well as for each of the SSB, CW, FSK/PSK, AM/FM and DATA modes. Pressing and holding down the **F [MAX-Po]** key displays a Transmit Power Limit screen. Configure the transmit power on this screen. Turning the **[PWR]** knob clockwise continuously increases the transmit power to the preconfigured upper limit. Transmit power via TX tuning can also be limited.

An external device such as a linear amplifier may have different gains or withstanding input powers by band, thus the required transmit power varies in most cases. Transmit power for each band can be configured on the Transmit Power Limit screen. If the maximum transmit power has been configured on the screen, this eliminates troublesome transmit power adjustment with the **[PWR]** knob each time the band is changed.

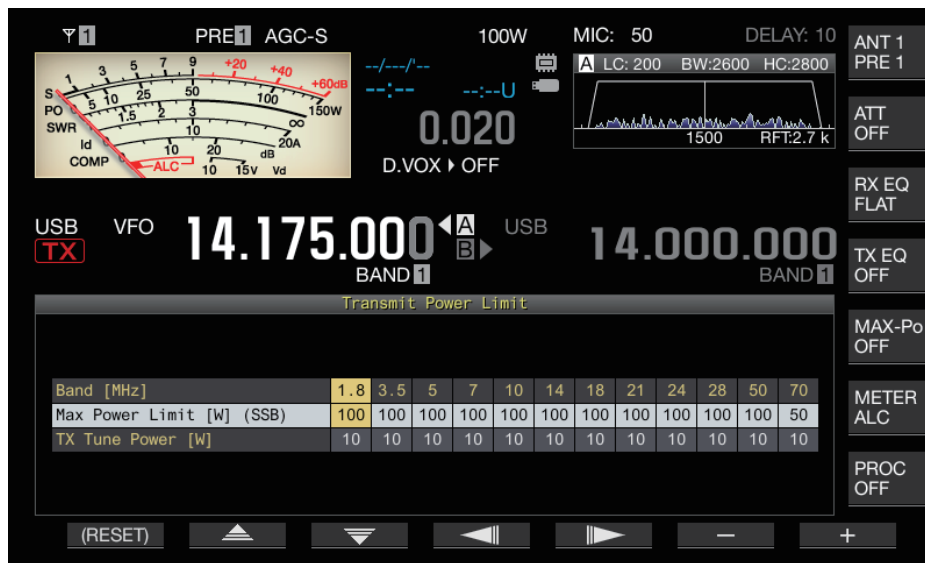

Fig. 19 Setting Screen for the Max Power Limiter Function (E type)

**Note:**

- ◆ Transmit power cannot be configured individually for each antenna connector (ANT1 and ANT2).

## ALC Operation when an External Device is Connected

The “Connection Block to an External Device for ALC Signal Input” diagram shows the connection block with an external device when ALC signal is input from the external device to the TS-890S as well as changes in the output level with the ALC voltage.

It employs a method that controls the TS-890S gain by using an ALC voltage output from an external device, but it consequently serves to control the TS-890S transmit power. This operation is common for both linear amplifiers and transverters. The gain level of the IF circuit in the TS-890S lowers when the ALC voltage input from the external device falls below -4 V (default setting). The gain decrease also leads to reduction of the transmit power (ANT output and DRV output); this serves for output control.

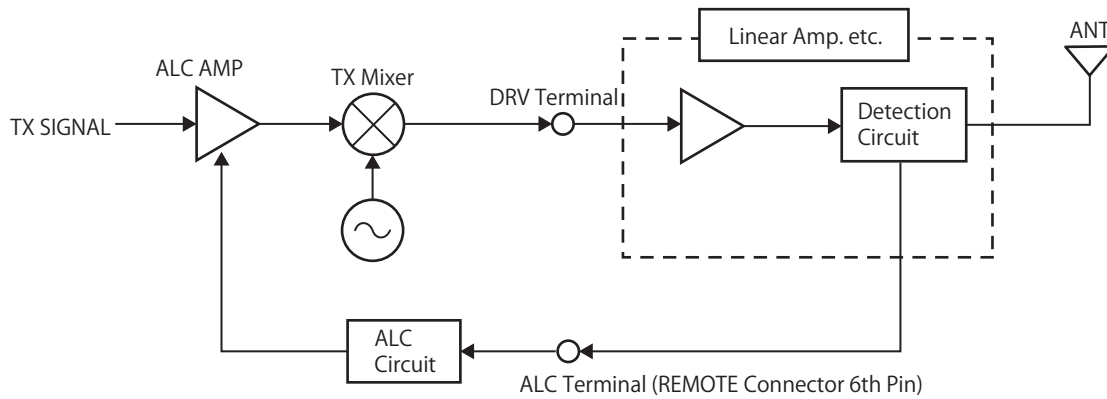

Fig. 20 Connection Block to an External Device for ALC Signal Input

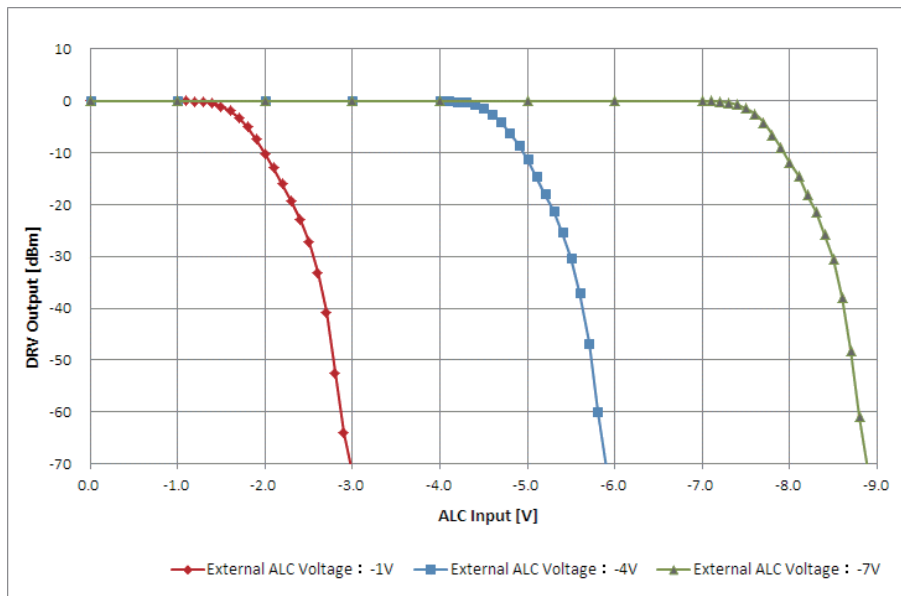

Fig. 21 Changes in DRV Output Level with ALC Input Voltage

### ● Operation on an ALC Signal Input from an External Device

Adjusting the microphone gain and carrier level to optimize the ALC meter needle deflection while no ALC signal is input from an external device enables more feedback control for the ALC when an external ALC signal is applied. Therefore, the increase causes the ALC meter needle to deflect wider. In this case, turn the **[PWR]** knob counterclockwise while monitoring the ALC meter needle deflection or readjust the microphone gain and carrier level.

# DRV Terminal

The output level from the **DRV** connector is approximately 0 dBm (1 mW). Power detection is performed for output from the **ANT** terminal, and the output will not exceed the preconfigured level due to activation of ALC. However, the output level will fluctuate as ALC will not be activated for the DRV terminal output if ALC signal is not input from the external device. This output level can be configured to a level between 100% and 5% using the **[POWER]** knob. To decrease the output level to 5% or lower, turn the **[CAR]** knob in a mode other than SSB, or turn the **[MIC]** knob (microphone gain) or **[PROC OUT]** knob (speech processor output level) in the SSB mode. The level for the output signal from the DRV connector is insufficient to be transmitted directly through an antenna. Operation with a transverter or connection to the high-gain linear amplifier allows operation in the 135 kHz band and other bands.

The diagram below shows the spurious characteristics from the **DRV** terminal in the 14 MHz band. The harmonic level also changes upon change of the level to 0 dBm, - 10 dBm, and - 20 dBm.

DRV outputs that do not pass through a low-pass filter may include a lot of harmonic components.

For transmission, eliminate such harmonic components by passing the signal through a low-pass filter as needed after signal amplification. Also, lowering the level using the **[POWER]** knob or applying the ALC signal from the **REMOTE** connector to limit the **DRV** connector output level can help to reduce distortion.

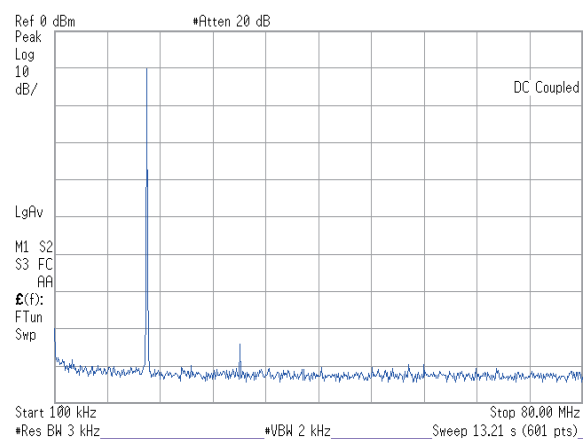
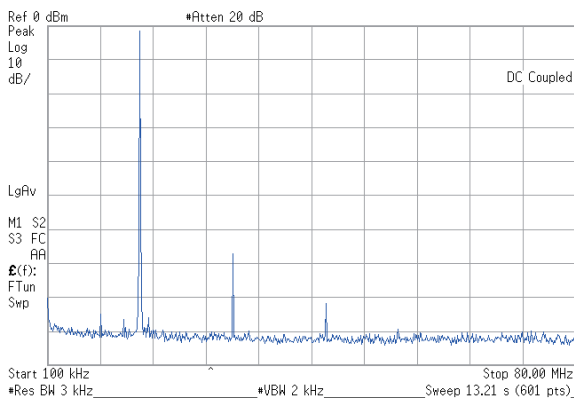

Fig. 22 DRV Output Characteristics 14.175 MHz 0 dBm    Fig. 23 DRV Output Characteristics 14.175 MHz -10 dBm

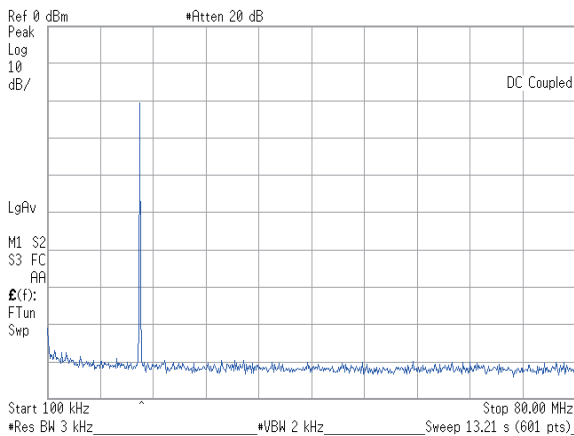

Fig. 24 DRV Output Characteristics 14.175 MHz -20 dBm



## Protections

The TS-890S employs a final amplifier circuit configuration for a 100 W transmit power output with sufficient margins. Consequently, protections against large currents and excessive heating are provided, taking account of safety

### SWR Protection

Not only does a high antenna SWR impede efficient radio wave radiation, distortion may occur in the final circuit due to the reflected waves, and the TS-890S or the antennas may be damaged as a result. To prevent such a problem from occurring, a protection circuit is implemented to reduce the transmit power to reflected waves. The protection circuit starts reducing the transmit power when the SWR becomes 1.5 or higher.

### Overcurrent Protection

A protection circuit is implemented to monitor currents in the final amplifier and prevent currents over a specified level from passing through.

### Thermal Protection and Fan Control

The TS-890S is equipped with two final amplifiers with thermistors placed near them. The thermistor monitors the final FET temperature and switches the rotating speed to one of the three levels based on the detected temperature. The “Cooling Fan Rotation Speeds and Final Amplifier Fan Activation Temperatures” table shows the relationship between the speed of the cooling fan for the different components and the final amplifier temperature. If the final amplifier temperature continues to rise even while the cooling fan is running, the transmission power will be limited or transmission will be stopped and restored to the receiving state to prevent malfunction.

Table 5 Cooling Fan Rotation Speeds and Final Amplifier Fan Activation Temperatures

Fan Rotation Speed	Final Amplifier
Low	Approx. 60 °C
Medium	Approx. 70 °C
High	Approx. 75 °C

# 04 LOCAL OSCILLATOR CIRCUIT

## Local Oscillator

The local oscillator circuit in the TS-890S is configured to obtain the characteristics needed for each signal, such as the VCO (Voltage Controlled Oscillator) division type for the first and second oscillator signals and DDS (Direct Digital Synthesizer) direct system for the third local oscillator.

### First Local Oscillator Signal

To obtain high-quality C/N (Carrier-to-Noise ratio) characteristics, the first local oscillator signal is configured by further developing the VCO division type adopted on the TS-990S to achieve a VCO device with a high C/N in the gigahertz band as well as a reference oscillator circuit that excels in adjacent C/N characteristics.

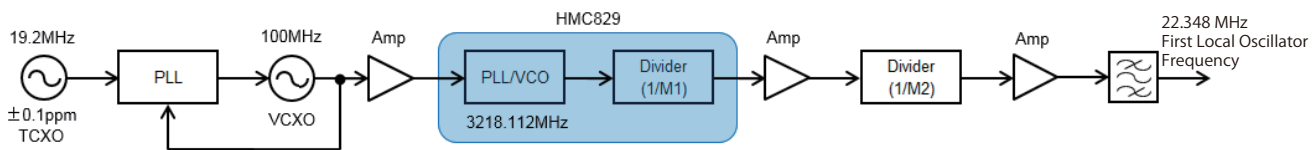

Fig. 25 Block Diagram of First Local Oscillator Signal (Reception of 14.1 MHz Signals)

19.2 MHz reference frequency is input as the reference signal of the PLL (Phase Locked Loop) device, and the PLL loop is applied to the 100 MHz signal to generate signal with excellent C/N characteristics.

The 100 MHz signal that is generated is input to the VCO device (HMC829) to generate signal with a high C/N in the gigahertz band within the device.

The generated signal is then divided and passed through the amplifier and bandpass filter before it is output as the first local oscillator signal.

Theoretically, the C/N characteristics of gigahertz band signals generated inside the device are improved by the effect of division at the ratio of  $20 \cdot \log(\text{division ratio})$ .

(1/10 division:  $20 \cdot \log(1/10) = -20\text{dB}$ )

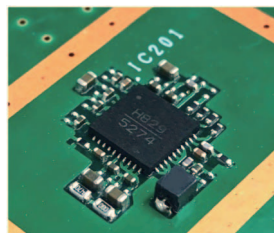

Fig. 26 HMC829

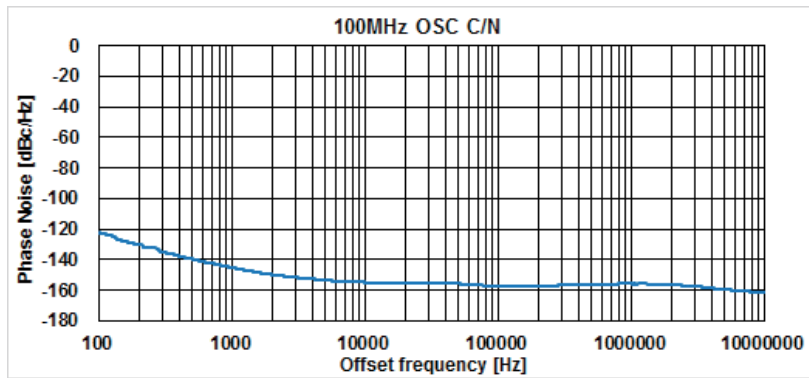

Fig. 27 100 MHz OSC C/N Characteristics

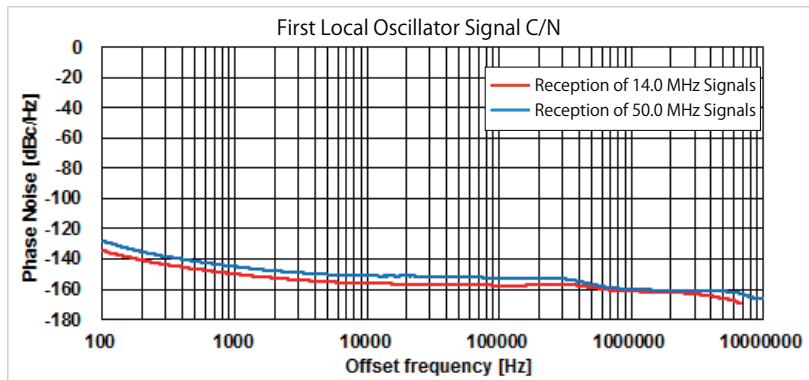

Fig. 28 First Local Oscillator Signal C/N Characteristics

# 05 ANTENNA CONTROL CIRCUIT

## Signaling Paths

The TS-890S has two antenna connectors, **ANT1** and **ANT2**, an **RX IN** and an **RX OUT** connector that can be used for reception-only antenna input or connection of an external filter, as well as **ANT OUT** connector that can be used to connect the receiver to an external device.

There are different paths that connect the antenna to the receiver. It is possible to switch the path from the antenna to the receiver by altering the settings.

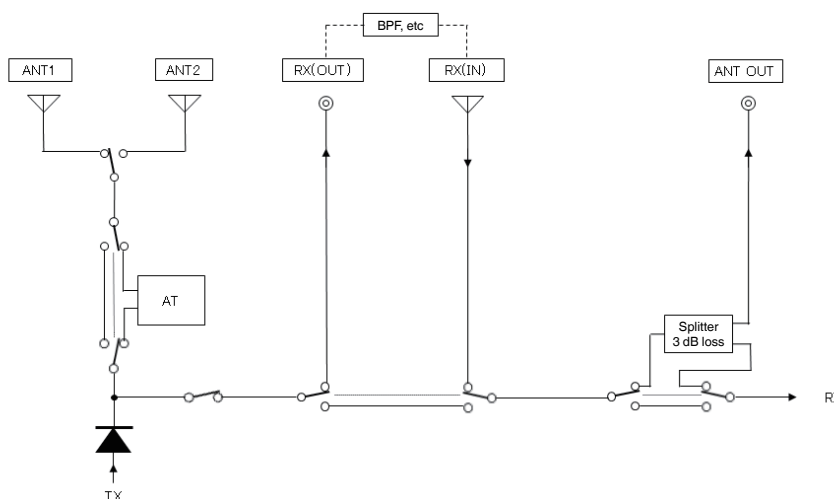

Fig. 29 Signaling Paths

### RX Antenna Feature (RX IN / RX OUT Connectors)

The RX Antenna is a feature that receives signals via the **RX IN** connector or sends the received signals from the **RX OUT** connector when a reception-only antenna such as a low-band Beverage antenna or loop antenna is used, when a bandpass filter is appended externally, or when a transverter is connected.

When the **[RX ANT]** key is pressed to activate the RX antenna feature, signals from the antenna connectors (ANT1 and ANT2) are blocked, allowing reception of signals input to the **RX IN** connector or output of signals from the **RX OUT** connector.

To append an external bandpass filter, connect it between the **RX OUT** and **RX IN** connectors. However, reception is not possible if signals are not correctly input to the **RX IN** connector.

#### Note:

- ◆ Install the RX antenna and TX antenna as far apart as possible. When transmitting from the TX antenna, a part of the transmit power is induced on the RX antenna. Especially when using a linear amplifier, the RX antenna generates high voltage. Note carefully that the high voltage may be applied to the RX IN connector of the TS-890S and may cause a failure.

### Antenna Output Feature (ANT OUT Connector)

The TS-890S comes with an “Antenna Output Connector” for outputting signals from the antenna to an external device.

When the **[RX ANT]** key is pressed and held down to activate the antenna output feature, signals from the antenna connectors (ANT1 and ANT2) can be split using a splitter circuit and the branched signals can be output to the **ANT OUT** connector.

In principle, the splitter circuit has a 3 dB loss.

## TS-890S User Report

### ● Report from actual users of the TS-890S

- Dual receive with split transfer A feature

Although the TS-890S does not have a simultaneous dual-band reception feature, it can be combined with the TS-590 series or another TS-890S transceiver to offer a powerful dual-receive feature. While the basic operation is application of the split transfer function, the conventional split transfer feature is further expanded on the TS-890S to enable smooth operation with simultaneous reception of two bands.

There are two split transfer modes, A and B, for the transceiver pair. Between them, the newly-added split transfer A is closer to the simultaneous reception function available on models such as the TS-990S.

Transceivers that can be combined include the TS-890S series, TS-590G series and TS-590 series (only functions as a sub-receiver). When combining the TS-890S with a TS-590G model, it is also possible to configure one of them as the main transceiver.

The TS-590 series does not have a feature for branching the output received into two, and thus cannot be configured as the main transceiver. Use an RS-232C cross cable to connect the COM ports of the two transceivers to enable mutual transfer of data.

Firmware compatibility is necessary on the TS-590 transceiver in order to use this feature on a TS-590 or TS-590G transceiver. (TS-590:Ver.2.04 or later/ TS-590G series:Ver.1.05 or later)

Both the TS-890S and TS-590 series comes with a 9-pin D-sub COM port. Connect them using an RS-232C cross cable and configure the necessary items for split transfer A in the menu.

D-sub 9-pin RS-232C cross cables are sold as "interlink cables". Connect the antenna terminal of the TS-590 with the ANT OUT terminal of the TS-890S using a coaxial cable, followed by setting the ANT OUT feature on the front panel of the TS-890S to ON.

Doing so distributes the signal from the antenna to the TS-890S unit and the TS-590.

By configuring the sub-receiver settings for split transfer A on the TS-590, transmission is prohibited automatically and therefore there is no need for manual setting to prevent inadvertent transmission by the TS-590.

Configure the TS-890S as follows.

- Menu [7-04] "Quick Data Transfer": Select A (TX/RX)
- Menu [7-00] "Baud Rate (COM Port)": Select 115200 [bps]
- Menu [3-12] "Split Frequency Offset by RIT/XIT Control": Select TX Frequency Offset while RX

Configure the TS-590 as follows.

- Menu [64]: Select A-SUB R
- Menu [67]: Select 115200 bps

Enable the split operation mode on the TS-890S and set VFO A/B. When TX VFO on the TS-890S is altered, the RX frequency on the TS-590G will change automatically. To change the TX frequency on the TS-890S, set XIT to ON and turn the RIT/XIT knob. Alternatively, the RX frequency of the TS-590 can be adjusted by pressing and holding down the TF-SET button and turning the main dial at the same time. When the frequency on the TS-590G is altered, this is transferred to the transmitting end of the TS-890S by pressing the Q-MIN button on the TS-590G.

The photo below shows the display screens on the TS-890S and TS-590 with split transfer feature 1 enabled.



The quickest way to enter the split operation mode is to long-press the SPLIT button on the TS-890S until the band direct key starts flashing. Next, push the frequency to offset for the transmitting call to enter the split mode for simultaneous reception of two bands. The frequency to call will be received from TS-590.

Turn the RIT/XIT knob on the TS-890S to control the RX frequency of the TS-590 (TX frequency of the TS-890S).

Wiring will be required by individual users for audio signal output using the TS-890S and TS-590G. The illustration is an example of inputting monaural signal output from each of the transceivers to the audio mixer of the sound equipment, followed by turning PAN on the mixer (BAL in the case of a stereo mixer) to allocate the main and sub signals to the left and right and distinguish the signals by listening through the headphone.

The respective audio levels can be adjusted using the sound mixer knob to configure the signals to the desired state from MIX to complete separation.

Perform trial and error to output the TS-890S signal at the same level to both the left and right sides. Next, by outputting the audio signal of the TS-590G to only the left or right side, it will be possible to distinguish the sound of the TS-890S and that of the TS-590G clearly when listening to the TX frequency during split operation.

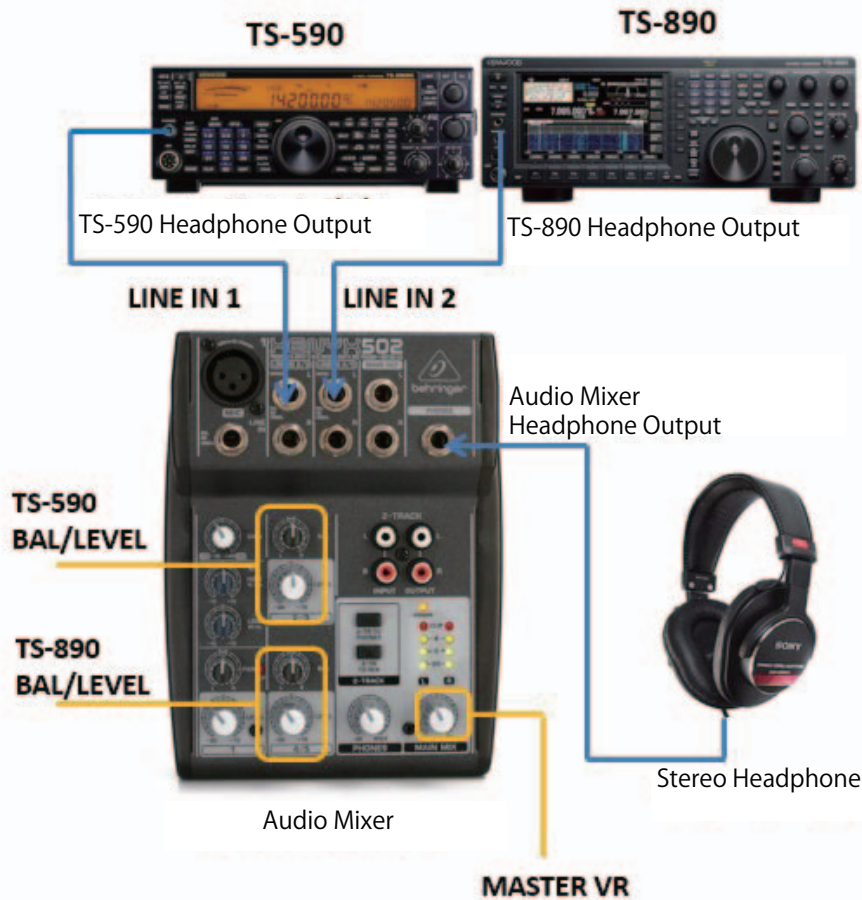

By assigning the function for muting the audio output of the TS-590G to the PF button on the TS-890S, the audio signal of the TS-590G can be muted simply by pressing this button even when simultaneous dual-band reception is in progress.

When transmission starts, the TS-590 automatically switches to the standby state based on information transmitted from the TS-890S. In this case, TX audio from the TS-590 will not be audible and the S-meter will not deflect.

The TS-890S and TS-590 combination offers the best user experience for simultaneous dual-band reception. In the past, the simultaneous dual-band reception function have been used on many models, and the level of allowance or certainty is exceptionally high when operating the TS-890S. One of the advantages of using two separate transceivers is that the actions can be easily monitored during operation.

If a transceiver with a simultaneous dual-band reception feature is used at all times for simultaneous reception, users may have more allowance once they become more familiar with the operation. However, if the transceiver is employed for simplex operation most of the time, it will be a hassle to perform precautionary checks when switching to simultaneous dual-band reception. Taking this point into account, it is a great advantage to be able to enter split operation while receiving signals on the sub-receiver with ease since there are separate rigs.

This is a lavish setup, but for users who already have a TS-590 and would like to enjoy smooth simultaneous dual-band reception with the TS-890S, then there is no need to let go of their current TS-590 unit. For users who do not have the TS-590 (not necessary to have the TS-590G), there are ways to look for one at an affordable price.

## 06 MPU PERIPHERAL CIRCUIT

---

The MPU peripheral circuit of the TS-890S is made up of the following parts.

- MPU peripherals for transceiver control
- MPU peripherals for application control
- MPU peripherals for operation panel control

### MPU Peripherals for Transceiver Control

MPU peripherals for transceiver control are made up of EEPROM for backing up the functional settings, Reset IC for monitoring the operating power voltage, RTC IC for time management of the system, and expanded output IC for output of control logic signals.

The key roles of the MPU peripherals for transceiver control include management of the transceiver status and transmission/reception control.

### MPU Peripherals for Application Control

MPU peripherals for application control adopt a built-in ARM Cortex-A8 MPU. It has an internal operating frequency of 600 MHz, and consists of one 8 GB eMMC external memory and two 1 GB DDR2 memories.

The key roles of the MPU peripherals for application control include display on the 7-inch monitor, output to external monitors (DVI connector), and control related to USB devices and LAN.

### MPU Peripherals for Operation Panel Control

MPU peripherals for operation panel control are made up of a touch-panel detection circuit, LED drive circuit, volume controls, encoders and switches.

The key roles of the MPU peripherals for operation panel control include backlight brightness control, detection of touch-panel operation, LED drive, LED brightness control, detection of volume control operation, detection of encoder operation and detection of push switch operation.



# 07 DSP

The TS-950 series HF transceivers were the world's first amateur radios with built-in DSPs.

The TS-870S achieves all IF signal processing with DSP, including the IF AGC for controlling the received signal level and the steep IF filter.

The TS-590S series provides evolved IF AGC for fine sound quality durable over long-time operation and functions for noise/interference rejection and boasts of top-level reception characteristics by means of DSP.

The TS-990S series is an integration of our traditional techniques

We have been providing "Quality" in communications that cannot be realized only by analog circuits.

The development concept of the DSP for the TS-890S is the ability of its application to actual operations. It has gone through a thorough brush-up to deliver the best performance under harsh and unfavorable conditions.

## Features of TS-890S DSP Technologies

- Two 32-bit floating-point DSPs for transmission/reception and bandscope respectively
- A significantly wider range of IF filter options
- AGC Quick Recovery feature added to the well-received IF-AGC
- Two types of digital noise blankers
- Bandscope with high resolution and high display refresh speed

## DSPs and Peripheral Hardware

32-bit floating-point DSP SHARC processor made by Analog Devices Inc., the same processor used on the TS-990S, has been adopted for the DSPs of the TS-890S, which are kernels of digital signal processing. There are two SHARC processors (referred to as DSPs hereafter) on the TS-890S.

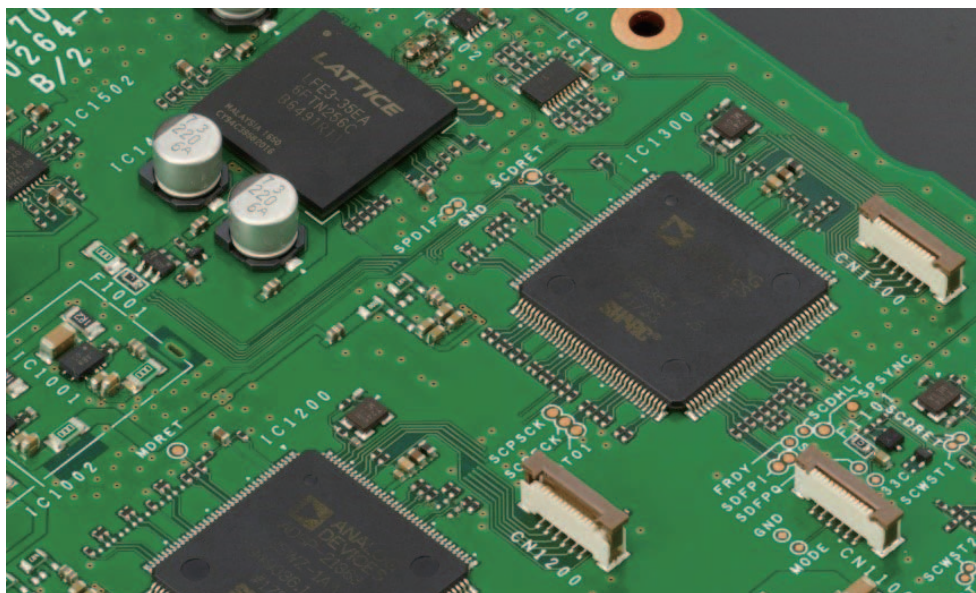

Fig. 30 Two SHARC Processors

The DSP for transmission and reception is called the "TXMRX DSP", while the DSP for signal processing for display on the bandscope and other devices as well as for decoding in RTTY and PSK31/PSK63 modes is called the "SCP DSP". The TXMRX DSP and SCP DSP are placed in the DSP unit and DSPs are linked together to perform digital signal processing.

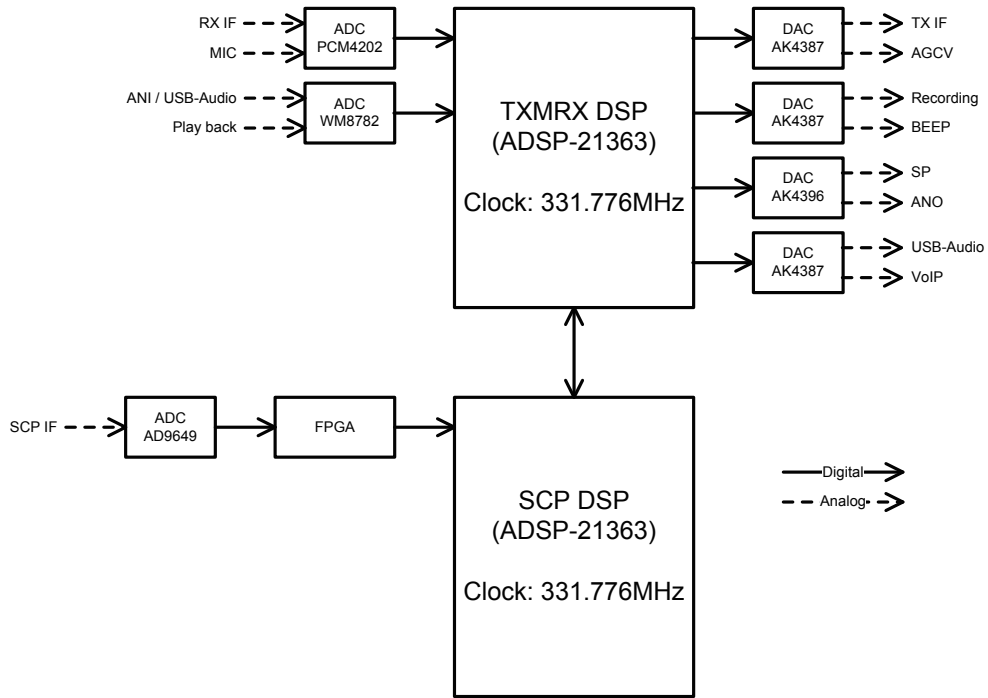

Fig. 31 DSP Hardware Block Diagram

## Signal Processing in the IF Stage

The IF AGC for signal reception forms the core that determines the character of the TS-890S.

Following advancements of analog circuits and digital signal processing, the IF-AGC has undergone many innovative developments while inheriting the tradition. New enhancements have also been made on the TS-890S.

### IF-AGC

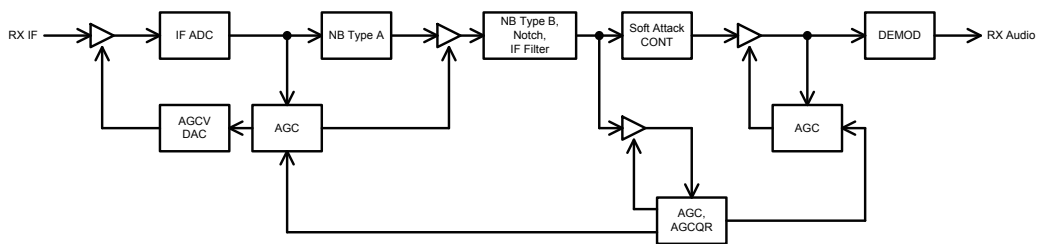

Fig. 32 IF Stage Block Diagram

AGC loops of the TS-890S are placed before and after the interference rejection, such as an IF filter or notch filter. The AGC loop of the preceding stage functions to prevent signals whose level is higher than the reference from being input to the A/D converter for the IF input and is called the out-band AGC loop. The AGC loop of the succeeding stage has the same AGC performance as the predecessors and is called the in-band AGC. With the in-band AGC operated after the IF filter and interference rejection, the desired signal can be highlighted.

The basic approach to AGC response characteristics is to control the AGC amplifier gain with an ultra-high-speed attack in the same way as conventional transceivers to control the gain without causing unnecessary amplitude fluctuation, and to reduce factors causing fatigue due to long hours of listening.

One of the factors causing fatigue felt from listening are a momentary signal level overshoot by high-speed attacks. This phenomenon is inevitable in highlighting weak signals and minimizing distortion on the receiver. However, demodulation with the phenomenon causes the sound quality to be hard, and the high-processing-speed release setting is of no use. The sound quality at attacking is based on the comprehensive characteristics including the characteristics of the AGC amplifier in the analog stage as well as the characteristics of the AGC loops in the preceding and succeeding stages and the IF filter.

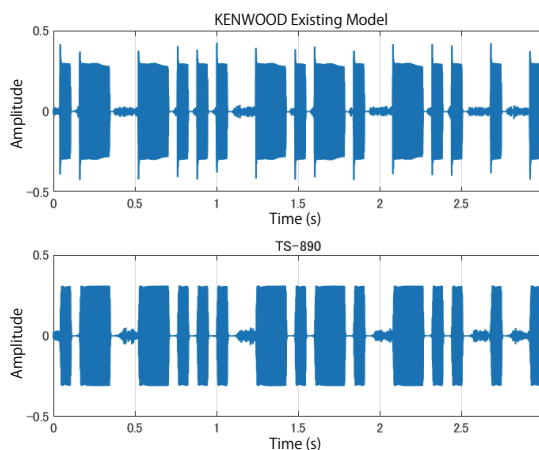

Fig. 33 Comparison of Received CW Waveforms: Conventional Transceiver vs. TS-890S

### AGC Quick Recovery

AGC Quick Recovery is a newly-added feature on the TS-890S.

When pulse noise generated by sources such as an electric fence is received, the in-band AGC attacks the pulse noise to lower the gain of the AGC amplifier. Activation of the in-band AGC suppresses not only the pulse noise but also the target signal, making it impossible to watch the target signal or resulting in an unpleasant phenomenon where the volume level of the target signal fluctuates with the repeated pulse noise attacks and releases.

The AGC Quick Recovery is a feature that detects attacks on the pulse noise and restores the gain of the AGC amplifier instantaneously, thus making it possible to prevent unnecessary suppression of the target signal.

The diagrams below show the in-band AGC input and output of IF signals containing pulse noise. The upper diagram shows the in-band AGC input and the lower diagram shows the in-band AGC output. AGC Quick Recovery is turned off in the earlier half of the time axis and signal suppression is observed, while signal suppression is improved when AGC Quick Recovery is turned on in the later half.

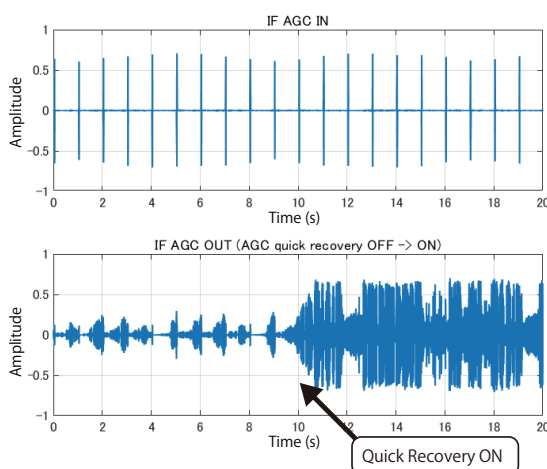

Fig. 34 Input/Output of Signal Containing Pulse Noise to In-band AGC (Quick Recovery OFF in Earlier Half and ON in Later Half of Lower Diagram)

## IF Filter

As the main band limitation filter, the TS-890S is equipped with roofing filters for the analog stage as well as DSP digital IF and AF filters (in addition to these, there are also audio peak filters, etc.).

In the SSB, CW, FSK, PSK modes, IF filter is installed in the preceding stage to the in-band AGC and AF filter to the succeeding stage. In the AM mode, the IF filter is also installed in the preceding stage to the in-band AGC but the AF filter is positioned after demodulation. In the FM mode, the IF filter is installed in the stage preceding demodulation, and the AF filter in the stage after demodulation.

Operating the transceiver to change the low-/high-cut filter or WIDTH alters the cut-off frequency of the roofing filters, IF filter and AF filter at the same time. However, the settings can also be changed to alter the frequency individually.

In the SSB mode, the IF filter is made up of a high-pass filter (high-cut) and a low-pass filter (low-cut), which allows the high-cut and low-cut frequencies to be altered. In the CW, FSK and PSK modes, the IF filter is made up of a bandpass filter, which allows WIDTH (passband width) and SHIFT (center frequency of filter) to be altered. In the SSB mode, the settings can be configured to change the low-/high-cut combination to WIDTH/SHIFT combination.

Compared to conventional models, the TS-890S offers a significantly wider variety of filter options in all the modes for more detailed tuning. In the AM mode, the passband width of the IF bandpass filter varies according to the high-cut setting of the AF filter. In the FM mode, the passband width of the IF filter varies when the setting is switched between Wide and Narrow.

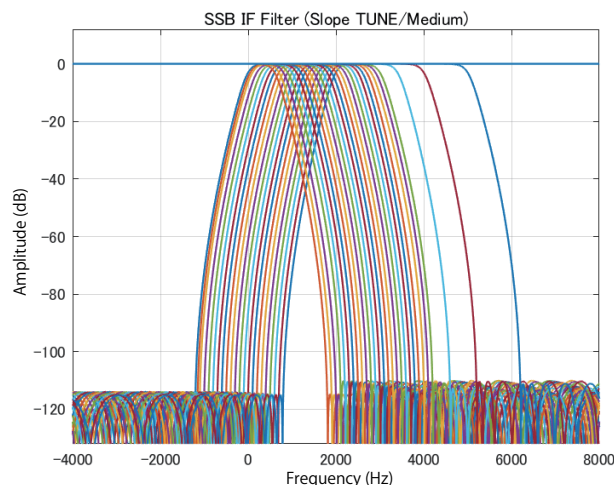

Fig. 35 IF Filter Characteristics in the SSB Mode (IF Filter Shape: “Medium”)

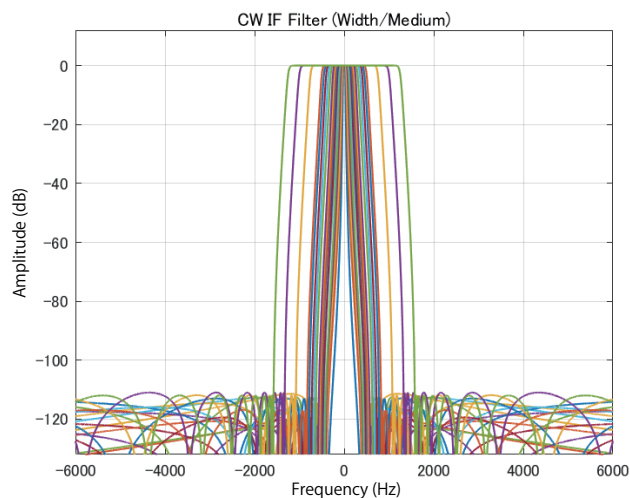

Fig. 36 IF Filter Characteristics in the CW Mode (IF Filter Shape: “Medium”)

In addition to the high-cut, low-cut and WIDTH settings, it is also possible to switch the IF filter shape (slope characteristics) on the TS-890S. To switch the IF filter shape, select “Sharp”, “Medium” or “Soft” on the RX Filter screen. The “Sharp” filter has the steepest slope, while the “Soft” filter has the most gentle slope

Table 6 IF Filter Characteristics (Slope Characteristics) and Shape Factors

RX Mode	Shape Factor (-60 dB BW/-3 dB BW)	Stop Band Attenuation
SSB (Low-cut, High-cut)	1.6/ 1.8/ 2.0 (Low-cut filter: 200 Hz, High-cut filter: 2600 Hz)	110 dB
SSB (WIDTH), FSK, PSK	1.5/ 1.8/ 2.0 (Bandwidth: 2400 Hz)	110 dB
CW	1.5/ 1.8/ 2.0 (Bandwidth: 500 Hz)	110 dB

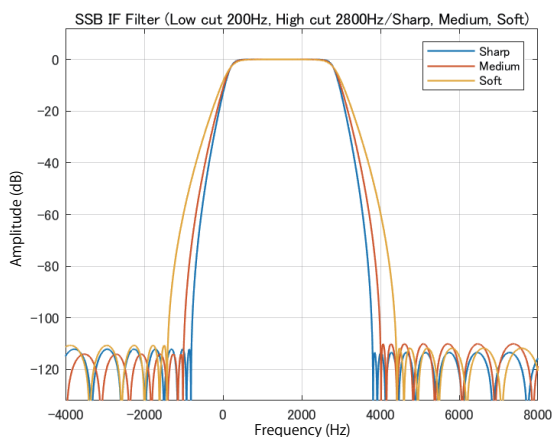

Fig. 37 Comparison of IF Filter Shapes in the SSB Mode (Sharp, Medium, Soft)

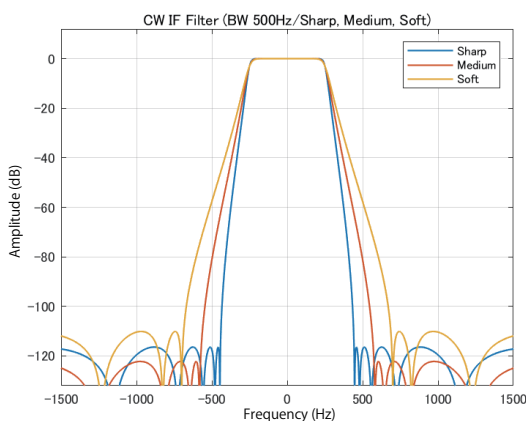

Fig. 38 Comparison of IF Filter Shapes in the CW Mode (Sharp, Medium, Soft)

The shape factors for determining the IF filter shape are designed based on a 2400 Hz passband width in the SSB, FSK and PSK modes and a 500 Hz passband width in the CW mode. By changing the high-/low-cut or WIDTH settings, it is possible to alter the passband width while maintaining the slope characteristics from cut-off up to the attenuation range.

Compared to the filter shape in the SSB mode, the reference passband width that determines the shape factor is narrower in the CW mode, which means the filter is sharpest in the CW mode. Such a sharp filter tends to cause ringing when the bandwidth is narrowed, and may affect the sound quality due to group delay in the SSB mode.

Employing the digital filter design technology that we have accumulated, the TS-890S now offers a filter and IF-AGC design that minimizes ringing as well as impact on the sound quality. As the roofing filter settings for the analog circuit vary in tandem with the specified filter bandwidth characteristics, interference by adjacent signals is less likely to occur when a narrow band of 500 Hz or lower is configured in the CW mode. At the same time, however, the ripple and group delay characteristics may also be affected in some cases.

Because of the relationship with the analog filter characteristics, only devising the digital filter does not attain practical listening sensation in sound quality refining. Tuning of IF-AGC described above helps to bring out the filter characteristics effectively.

## Interference Rejection

Interference signals such as pulse noise and beats may affect the IF-AGC and suppress the desired signals. In such cases, eliminating the interference signals in the preceding stage to the AGC can highlight the signal behind the interference signals.

Similar to the IF filter, interference rejection is a function that is placed before in-band AGC to eliminate specific interference signals. Two types of interference rejection via digital signal processing are available on the TS-890S: noise blanker and notch filter.

### ● Noise Blankers

The TS-890S has two noise blankers, NB1 and NB2. NB1 is the noise blanker for the analog circuit. NB2 is the noise blanker for digital signal processing. NB2 offers two modes, Type A and Type B, which can be employed for different situations. It is also possible to combine the use of NB1 and NB2.

NB2 Type A monitors the envelope of RX signals and performs blanking on the pulse noise when there are changes in the signal level beyond a certain level.

NB2 Type B is a new blanking technique that is based on the IF-AGC technology to enhance the accuracy of pulse noise detection. It allows blanking even when there is only a slight signal level difference between the desired signal and pulse noise signal. The diagram below shows how an audio signal suppressed by the IF-AGC operation can be highlighted when the pulse noise is eliminated by NB2 Type A or Type B.

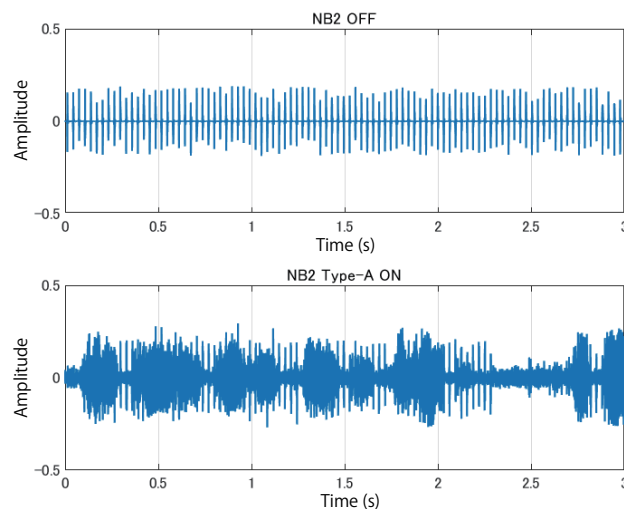

Fig. 39 Effect of NB2 Type A

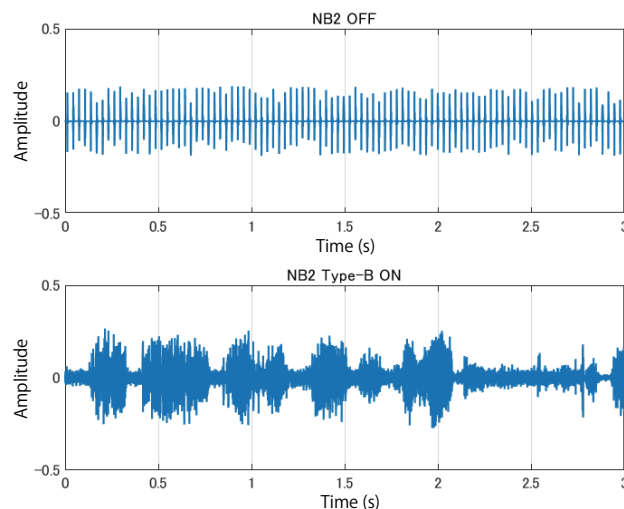

Fig. 40 Effect of NB2 Type B

NB2 affects the noise that cannot be processed by the analog circuit; however, there may be a case where it cannot suppress the noise depending on the strength of the desired signal and characteristics of the pulse noise.

In such a case, by using noise reduction together, the receiving status may be improved.

Also, use of a narrow roofing filter bandwidth may change the noise component that deteriorates its effect. Employing NB1, NB2 and noise reduction flexibly according to the circumstances enables you to handle a wider variety of situations.

### ● Notch Filter

The notch filter allows you to change the center frequency of the notch by turning the [NOTCH] knob.

The notch filter has an attenuation of 60 dB or higher at the notch center frequency. The diagram below shows how a minute signal suppressed by the IF-AGC operation can be highlighted when the beat is eliminated by the notch filter.

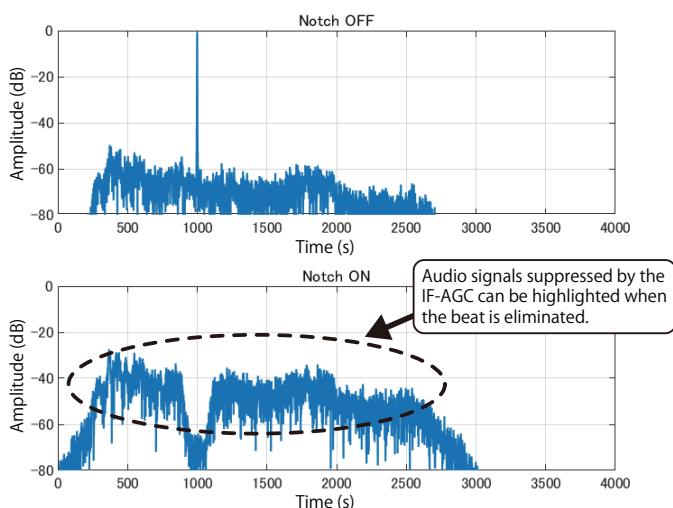

Fig. 41 Effect of the Notch Filter

Pressing and holding down [NCH] key switches the notch filter bandwidth in the sequence of “Normal (Narrow)”, “Medium” followed by “Wide”. “Normal” is effective for a single beat frequency.

In the case of interference by a signal in the SSB mode or when there is difficulty in hearing the desired signal due to its partial elimination after adjustment of the IF filter, selecting “Wide” for the notch filter may be more effective.

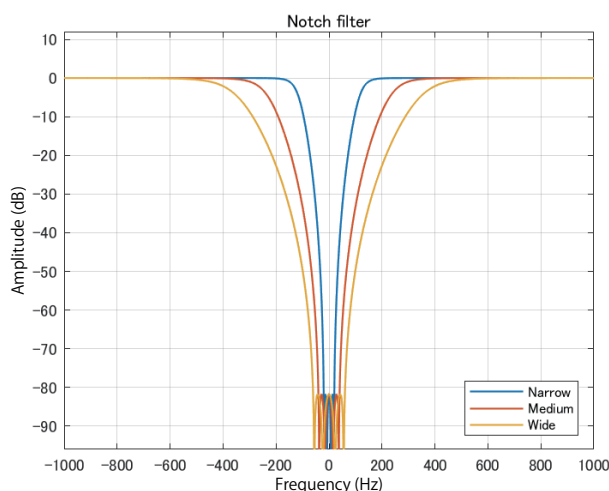

Fig. 42 Notch Filter Characteristics (Reference)

# Reception

## Demodulation

### ● SSB, CW, FSK and PSK Modes

Demodulation processing in the SSB, CW, FSK and PSK modes is based on the well-established PSN (Phase Shift Network) system.

The optimal design of the PSN system is determined by the characteristics of the IF filter that comes with the transceiver. If a steep and large-attenuation filter similar to the IF filter of the TS-890S is used, the number of reverse bandwidths to be canceled by the PSN system is very small. In the earlier section on IF filters, we have explained that the passband width, which is the basis for determining the shape factor, and also the IF filter configuration vary depending on the RX mode. By adopting a PSN design according to the IF filter to minimize the filter order, it is possible to improve the group delay characteristics on the low passband, which is a drawback of the PSN system.

Doing so enables quality sound to be obtained up to the lower band when the passband width of the IF filter is widened.

In the SSB mode, "0 Hz" can be configured as the low-cut frequency for the IF filter. This means that the cut-off frequency has been configured for the carrier point so as to extend the low passband to its maximum using the PSN system described above.

### ● AM Mode

In the AM mode, absolute demodulation is performed to obtain an envelope of the IF signal as a demodulation signal.

### ● FM Mode

In the FM mode, after mixer processing and conversion to I/Q signal are performed to convert the center frequency of the IF signal to 0 Hz, demodulation signal is obtained by performing Atan processing to extract and differentiate the  $\pi \sim +\pi$  phase component.

### ● FSK Mode

In the FSK mode, audio signal that is detected with the PSN system is output to a speaker or external output terminal regardless of the status of the RTTY decoder (On or Off). When the RTTY decoder is turned on, frequency is detected through a path that is different from that for audio output, and the RTTY baseband signal is acquired and used for decoding.

The RTTY decoder operates in the FSK mode (only if 170 Hz is configured for the shift width).

### ● PSK31/63 Mode

In the PSK mode, audio signal that is detected with the PSN system is output to a speaker or external output terminal regardless of the status of the PSK31/63 decoder (On or Off). When the PSK31/63 decoder is turned on, delay detection is performed through a path that is different from that for audio output, and the PSK31/63 baseband signal is acquired and used for decoding.

Also, the AFC (Automatic Frequency Control) feature can be used with the PSK31/63 decoder. AFC processing is performed on the path from IF to the decoder, but audio output signals will not be processed. This is to output the audio signal to the PC while using the internal decoder, thereby enabling AFC and decoding to be carried out concurrently by the decoder software, etc. that is installed on the PC.



## AF Filter

### ● SSB, CW, FSK and PSK Modes

The AF filter, which is placed after the in-band AGC, switches in tandem with the IF filter when the low-cut filter, high-cut filter or passband width is switched. For this reason, the AF filter is equipped with a similar function as the IF filter for changing the low-/high-cut frequency, WIDTH (passband width) and SHIFT (center frequency of the filter).

The AF filter plays the roles of assisting the IF filter and making the desired signal easier for hearing. Other filters for the audio signal after demodulation include the audio peak filter and RX equalizer.

Emphasis was also placed on the AF filter design of the TS-890S to process the signal in the stage preceding demodulation in the SSB, CW, FSK and PSK modes.

By combining demodulation using the high-performance PSN system, band limitation in the stage preceding demodulation will become equivalent to band limitation in the AF stage. This offers the advantages of shaping the filter (slope characteristics) and achieving a design with the group delay size of the steep high-pass filter (low-cut) for the audio signal maintained at about the same size as that of a low-pass filter (high-cut), thereby contributing to a high sound quality.

The IF filter is equipped with a function for switching the IF filter shape (slope characteristics), while the AF filter allows the bandwidth to be widened or narrowed with respect to the low-cut, high-cut or WIDTH settings configured for the cut-off frequency of the IF filter. There are three options on the RX Filter screen, “Narrow”, “Medium” and “Wide”. “Medium” sets the passband to one that is the same as that of the IF filter, “Narrow” sets the passband to one that is narrower than that of the IF filter, and “Wide” sets the passband to one that is wider than that of the IF filter. The AF filter has the effect of enhancing the sharpness of the sound and improving the ease of hearing. Selecting “Narrow” makes the sound sharper, while selecting “Wide” delivers a more analog-like sound with emphasis on the IF filter and AGC characteristics.

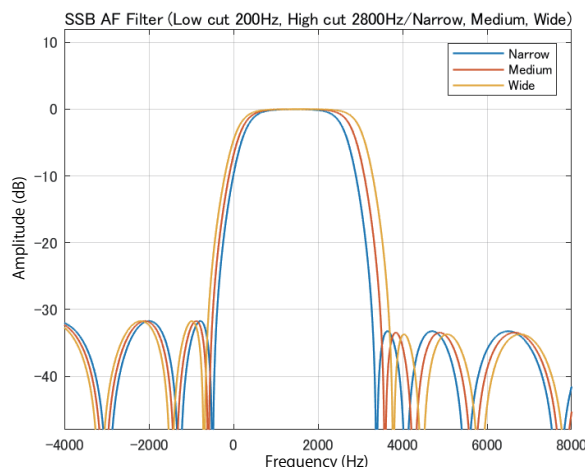

Fig. 43 Comparison of AF Filter Passband Width in the SSB Mode (Narrow, Medium, Wide)

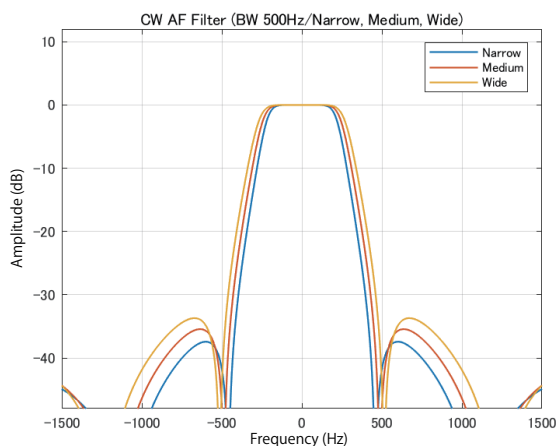

Fig. 44 Comparison of AF Passband Width in the CW Mode (Narrow, Medium, Wide)

## ● AM and FM Modes

In the AM mode, the AF filter is placed after demodulation.

It adopts a mechanism that switches the IF filter bandwidth when the high-cut frequency is switched. Meanwhile, switching the low-cut frequency alters only the AF filter setting. In the AM mode, extending the bandwidth only with the IF filter may cause the audio to sound distorted. Combining the use of the AF filter in this case allows the audio to stand out.

In the FM mode, it is possible to configure the low-cut or high-cut frequency of the AF filter for the audio after demodulation without affecting the IF filter setting. When the CTCSS feature is turned on, the high-pass filter is inserted in addition to the low-cut frequency filter to prevent the sub-tone signals from standing out.

As with the SSB and CW modes, it is also possible to select "Narrow", "Medium" or "Wide" on the RX Filter screen in the AM and FM modes.

## Audio Peak Filter

The audio peak filter is applicable in the CW and FSK modes.

In the CW mode, it is a peak filter with the pitch frequency as the center frequency which helps to enhance the intelligibility by highlighting the desired signal when it lacks intelligibility due to noise.

The passband width can be configured to one of the three levels ("Narrow", "Medium" and "Wide") to provide a maximum peak gain of +6 dB. The peak frequency can be shifted within the range of  $\pm 200$  Hz with respect to the pitch frequency.

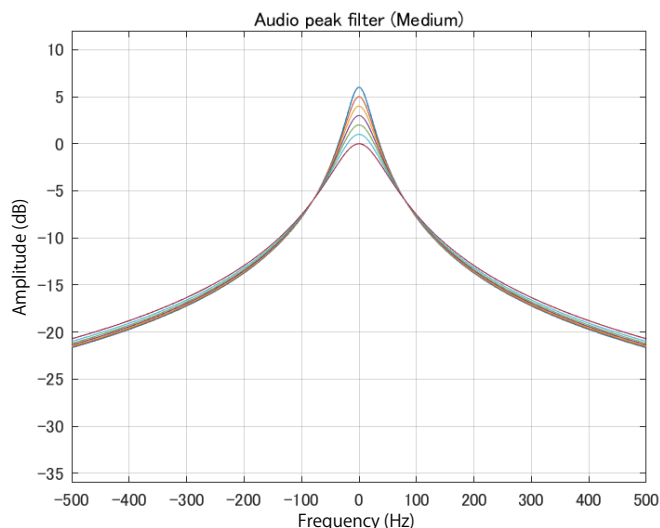

Fig. 45 CW Audio Peak Filter Characteristics (Medium)

## Noise Reduction

There are two methods available for noise reduction: NR1 and NR2. You can select the method that is more effective according to the operation mode and reception conditions.

For NR1, the algorithm that functions varies with the operation mode. In voice modes (SSB, FM and AM), noise reduction featuring the spectral subtraction method specialized for audio signals will function, and in non-voice modes (CW, FSK and PSK), noise reduction featuring the line enhancer method using the adaptive filter which emphasizes the periodic signals will function. The functioning algorithm will switch automatically with the mode.

NR2 employs what is known as a SPAC (Speech Processing system using the autocorrelation function) to piece together only the periodic waveforms detected from the received signal and output them as the received audio signal.

Table 7 Reception Modes and Noise Reduction Algorithms Used

Noise Reduction Method	Receive Mode	
	SSB, AM, FM	CW, FSK, PSK
NR1	Spectral subtraction	Line enhancer
NR2	SPAC	SPAC

### ● NR1 (Spectral Subtraction Method)

NR1 features a spectral subtraction method that estimates noise components contained in the received signal and eliminates (subtracts) only the estimated noise components from the received signal to highlight the desired signal.

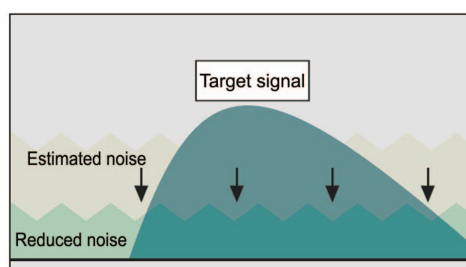

Fig. 46 Conceptual Scheme of NR1 Based on Spectral Subtraction

The spectral subtraction method is developed, intending to improve the intelligibility of weak signals received in SSB mode. Compared with the conventional NR1 (line enhancer method), the new NR1 has less impact on high-frequency voice components and realizes audio signal output with noise attenuation and minimum degradation of sound quality.

The TS-890S employs a technique to reduce musical noise (tonal “blip blip” sound that is minutely segmented) that is inherently generated as a result of the spectral subtraction process. With this technique, musical noise is largely reduced, and influence by digital processing that is incidental to noise reduction is lowered.

Additionally, with the spectral subtraction method, the NR1 allows adjustments to achieve a smooth noise elimination effect by controlling the amount of noise attenuation.

In principle, the noise estimation processing of the spectral subtraction method of NR1 also attenuates beats and CW signals as it identifies constant tones as noise components. Thus, while the conventional NR1 (line enhancer method) functions to emphasize beats and CW signals, the NR1 with the spectral subtraction method attenuates beats and CW signals together with noise components. However, since the NR1 featuring the spectral subtraction method is not intended for eliminating CW and beat signals, it does not have a large attenuation width for such signals.

To eliminate beats and CW signals, use the beat canceler.

The graphs below show how audio signal buried in the noise is highlighted by the NR1 with the spectral subtraction method.

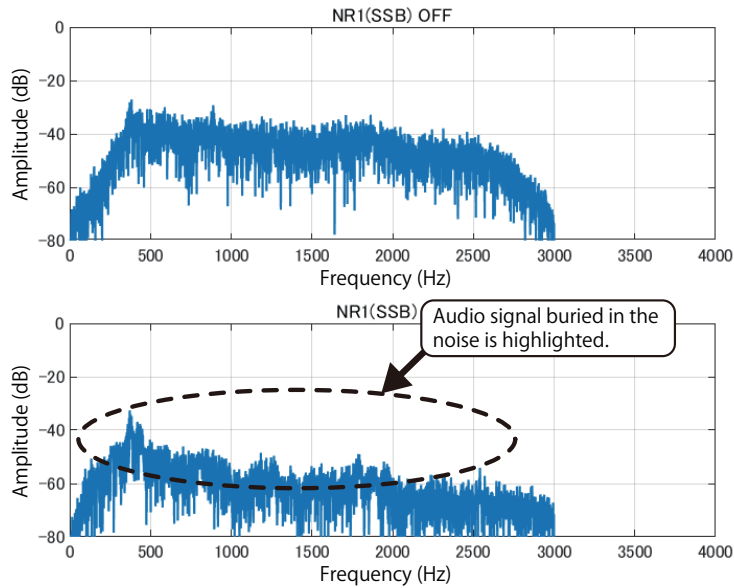

Fig. 47 Effect of NR1 with the Spectral Subtraction Method

### ● NR1 (Line Enhancer Method)

The line enhancer method, which employs a DSP, is widely used for general noise reduction.

The line enhancer method automatically changes the FIR filter characteristics according to the frequency components of the received signals. It provides high filtering effects particularly for periodic signals such as CW signals to improve the S/N ratio. Because the process automatically passes and emphasizes periodic signals, it is called a line enhancer (line enhancer method). The line enhancer employs a relatively simple signal processing system to improve the S/N ratio. At the same time, however, it also has drawbacks such as blurring the sound when processing weak signals in the SSB mode. It is positioned in the TS-890S as a noise reduction method for non-audio signals.

The graphs below show how NR1 improves the S/N ratio of a tone signal with the line enhancer method.

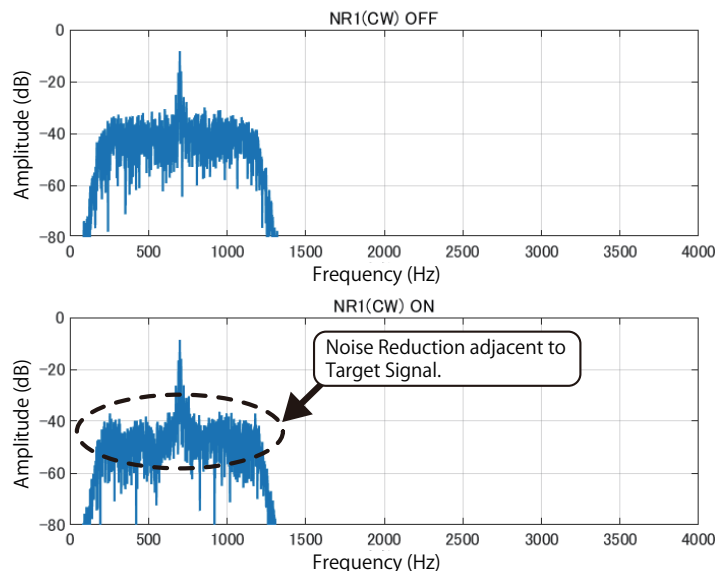

Fig. 48 Effect of NR1 with the Line Enhancer Method

## ● NR2 (SPAC Method)

The NR2 is for noise reduction with a speech processing system by using the Autocorrelation function, which is called SPAC (Speech Processing system by use of the Auto Correlation function).

This system enables to detect periodic signals contained in the received signal and to piece together the periodic signals detected as the received signal to be reproduced. Consequently, only the periodic signals in the received audio are highlighted clearly.

While the line enhancer method of NR1 makes use of a filter, NR2 adopts a different approach to signal processing from the line enhancer method. Therefore, NR2 is effective to signals with a single frequency such as CW signals. Also, the SPAC method characteristically detects the rising of a signal quickly, so it also delivers an effect to make attack parts of a CW signal more distinguishable.

These features make NR2 a very effective function in the CW mode. However, due to its operating principle, for less periodic audio signals, noise may be generated at parts where periodic signals are pieced together, which may make the audio less clear. In practical operation, we recommend the use of NR1 in the SSB mode and choose NR1 or NR2 depending on the circumstances in the CW mode.

The NR2 allows the autocorrelation time, which is important for periodic signal demodulation, to be specified within the range of 2 to 20 ms.

The optimum autocorrelation time differs depending on the receive conditions such as the frequency of the target signal and the noise contained in the received signal. Configure the correlation time while receiving signals to optimize the effect.

The graphs below show how NR2 improves the S/N ratio of a tone signal.

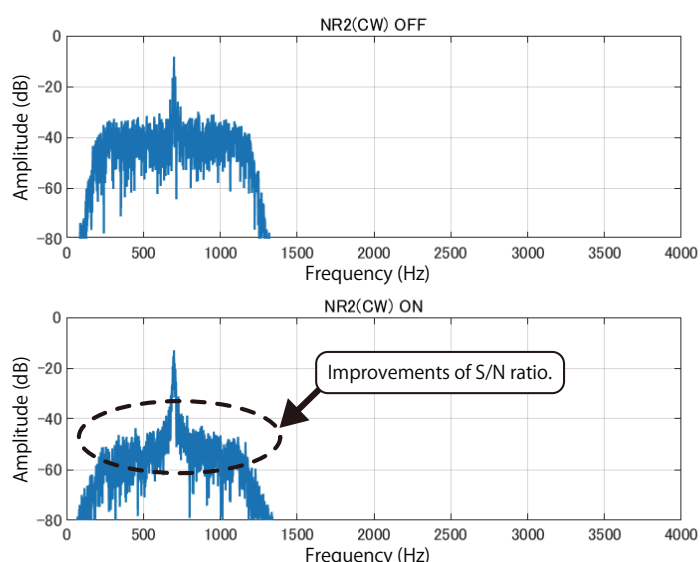

Fig. 49 Effect of NR2 S/N Ratio Improvement

## Beat Canceler

While the notch filter processes signals in the IF stage, the beat canceler suppresses the beat in the AF stage. Beat canceler is effective when there are multiple beat signals.

The beat canceler employs an adaptive filter technique which is of the same type as that for the NR1 line enhancer method. It cancels periodic signals such as a beat signal contained in the input signal by feeding the differences between the output signals from and the input signal to the line enhancer.

The graphs below show how multiple beat signals are canceled by a beat canceler.

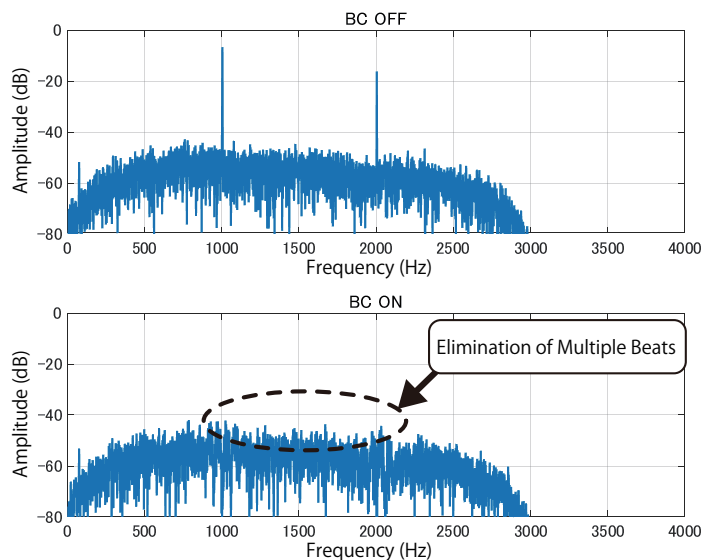

Fig. 50 Effect of Beat Canceler Elimination of Multiple Beats

There are two types of beat cancelers: BC1 and BC2. BC1 is tuned to be effective against weak or continuous beat signals. BC2 is tuned to be effective against intermittent beat signals such as Morse signals. The Beat Canceler is for beat signal elimination and do not work in the CW, FSK and PSK modes.

If there is beat interference that is stronger than the desired signal in an adjacent frequency during signal reception, IF-AGC may be activated by the beat signal. The beat cancelers process audio signals after demodulation, and thus while it is able to eliminate beat signals, it does not highlight the suppressed signals. For such cases, it is more effective to use the notch filter, which functions in the stage preceding IF-AGC.

## Signal Processing by Morse Code Decoder

The Morse code decoder is a feature that decodes Morse codes received in the CW mode and displays them as text on the screen. When we first introduced the Morse code decoder, which was on the TS-590G series, there were cases where erroneous decoding results were displayed under certain reception conditions. We have since made refinements to enable more accurate decoding under different situations.

The Morse code decoder on the TS-590G series performs envelope detection of IF signals based on absolute values, and is thus effective for decoding Morse codes with a considerable amount of noise components.

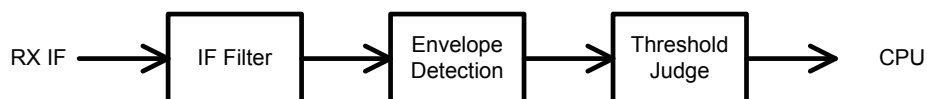

Fig. 51 Detection Block of Morse Code Decoder on TS-590G

By having the transceiver receive actual Morse codes and monitoring the IF signals, it was found that the amplitude fluctuates due to phasing. Detection of carrier via envelope detection may not be correctly performed for signals that are suppressed by the phasing process.

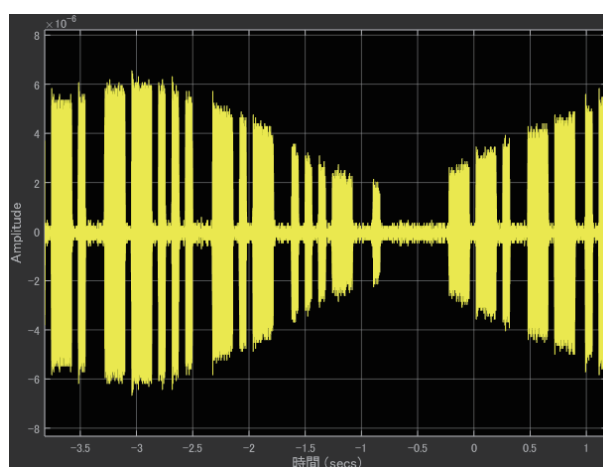

Fig. 52 Fluctuation of IF Signal Amplitude (Approx. S9)

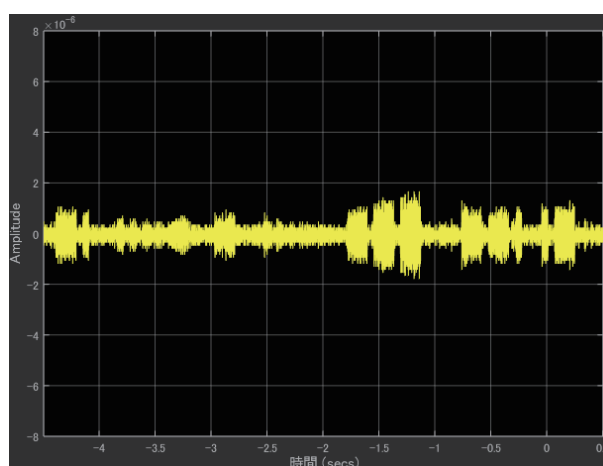

Fig. 53 Fluctuation of IF Signal Amplitude (Approx. S6)

On the TS-890S, the processing block has been modified to enable more accurate decoding.

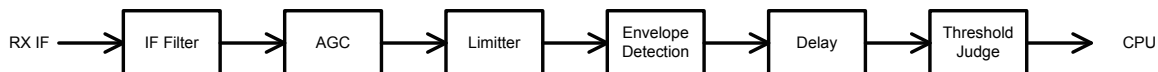

Fig. 54 Detection Block of Morse Code Decoder on TS-890S

Envelope detection is performed with Morse codes controlled at a constant level via AGC processing. The level assessment by AGC are then synchronized with the threshold assessment of envelope detection to enhance the decoding rate. At the same time, we have also optimized the settings to deliver a better user experience.

## Transmission

### Modulation

#### ● SSB Mode

Audio signal input from a microphone or an external input terminal is processed by the TX equalizer, microphone gain control and TX filter before it is being modulated. SSB modulation employs the PSN system, a well-established method among conventional transceivers that uses a 24 kHz carrier for modulation.

Unlike demodulation, modulation requires sufficient sideband suppression to be secured for the input bandwidth. This characteristic of PSN is designed to deliver sufficient suppression according to the characteristics of the TX filter, which is the bandwidth-limiting filter for transmission.

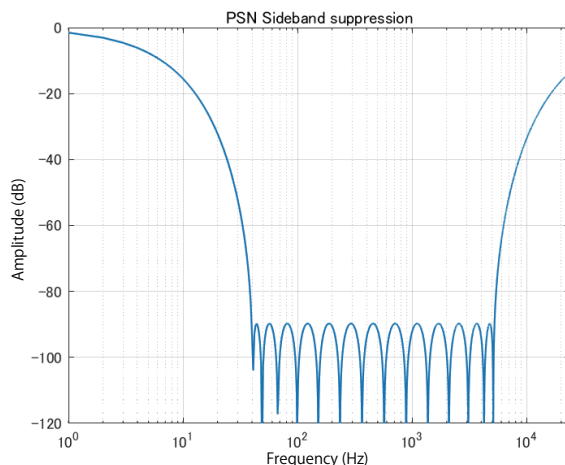

Fig. 55 Opposite Sideband Suppression Characteristics of PSN for SSB Modulation

In the SSB mode, the TX filter is made up of a high-pass filter (high-cut) and a low-pass filter (low-cut), which allows the high-cut and low-cut frequencies to be altered.

A high-cut frequency can be selected 2.5 kHz to 3 kHz, 3.5 kHz, and 4 kHz.



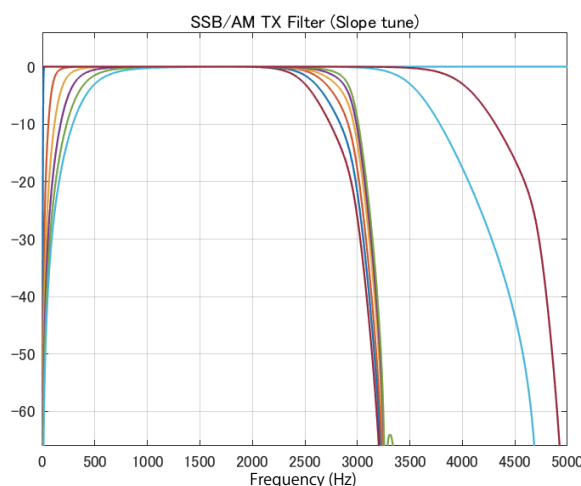

Fig. 56 Characteristics of the SSB TX Filter

TX monitoring audio is generated by detecting the IF signal in the final stage of DSP. This enables monitoring of audio signals that are close to those to be output as radio signals.

### ● CW Mode

The rising and falling waveforms of a CW keying signal is shaped to optimize the amplitude change to prevent the occupied bandwidth from expanding. The rise time can be configured to one of the four levels (1, 2, 4 or 6 ms) in the rise time setting. A smaller value represents a steeper rise and more dynamic sound quality, while a larger value represents a more gradual rise and softer sound. Using the waveform-shaped keying signal as the baseband signal, a modulated wave in the IF stage is generated through multiplication with the 24 kHz carrier.

Additionally, through multiplication with a carrier with an accurate tone frequency linking with the CW pitch frequency, a sidetone is generated. The rising and falling waveforms become the same shape as those of the modulated wave in the IF stage.

### ● FSK Mode

After baseband filtering, frequency modulation of the FSK keying signal is performed with the 24 kHz center frequency and preconfigured FSK Spacing (FSK shift frequency) to generate the FSK modulated wave.

Also, the frequency is shifted based on the audio mark frequency to generate the FSK modulated wave for monitoring.

For operation using the RTTY encoder, ASCII codes transferred from a USB keyboard or message memory are converted to Baudot (5-bit) codes. The start bit and stop bit are then added to generate the keying signal which is modulated in the same way as described above. FSK Spacing is fixed at 170 Hz when the RTTY encode is used.

### ● PSK Mode

In the PSK mode, a modulated wave is sent out only when the PSK31/63 encoder is active. No modulated wave is output when it is turned off.

BPSK or QPSK can be selected for the PSK31 encoder, and BPSK can be used for PSK63.

The ASCII code from a USB keyboard or message memory is converted to Varicode. Convolutional encoding is also performed in the QPSK mode. After baseband filtering is performed, quadrature modulation with a 24 kHz carrier is applied to generate a PSK modulated wave.

A separate PSK modulated wave for monitoring is also generated.

### ● AM Mode

As with the SSB mode, processing by the TX equalizer, microphone gain control and TX filter is applied before the signal is being modulated. A DC signal is added according to the AM modulated wave and modulation factor, and modulation is applied with the 24 kHz carrier.

## ● FM Mode

Similar to the SSB and AM modes, after processing by the TX equalizer and other filters, filtering by the pre-emphasis filter and 3 kHz low-pass filter for band limitation are applied and the sub-tone signal is superimposed. Next, modulation with the 36 kHz center frequency is performed to generate the FM modulated wave.

### Microphone Gain Control

Microphone gain can be adjusted by turning the **[MIC/PITCH]** knob.

Audio from the microphone is converted by the A/D converter to a digital signal, which will be sent to the DSP. The TX audio signal input to the DSP is subject to band limitation by the TX filter, and its level is adjusted by the MIC-AGC so that it does not exceed the reference level configured for the DSP.

If the signal level exceeds the reference level, for instance, when the configured value of the microphone gain is higher than the audio signal level for transmission, the audio gain level for transmission will be lowered. The reference level is equivalent to the level that fully deflects the ALC meter needle in the SSB mode, and equivalent to the maximum modulation factor in the AM and FM modes.

The TS-890S supports modulation by mixing signal input from either the ACC 2 connector, USB audio or VoIP with input from the microphone. In other words, MIC-AGC can be used for mixed audio signals.

Microphone gain for audio that is not from a microphone can be adjusted independently using “Audio Input Level” on the menu screen.

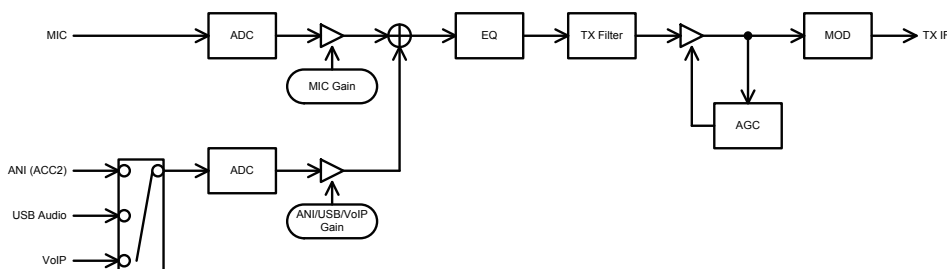

Fig. 57 Microphone, ACC 2 Connector, USB Audio Input, VoIP Input and Amplifier Processing

### Speech Processors

The TS-890S is equipped with a speech processor in the IF stage in the SSB mode (hereinafter referred to as “IF speech processor”) and a speech processor in the AF stage in the AM and FM modes (hereinafter referred to as the “AF speech processor”).

The speech processor is a feature that amplifies the average power of the modulated wave within the maximum power limit to enhance the intelligibility of the receiving stations. The speech processor is intended as a function to amplify the average power of the modulated wave in the SSB mode, but it also increases the average power of the audio in the AM and FM modes, thereby enhancing the intelligibility of the receiving station.

The IF speech processor compresses the modulated wave in the IF stage. Unlike the compression in the AF stage, harmonics generated by distortion due to compression are outside the audio band. The bandpass filter eliminates distorted components outside the audio band from the compressed signal to achieve a high average power (talk power) with less distortion than that of the AF speech processor.

To pursue a dynamic sound quality to be called back during pileup, select “Hard” on the Speech Processor Effect screen. In comparison with “Soft”, this causes more compression of the modulated wave. The TS-890S is designed not to alter the frequency characteristics even when the Speech Processor Effect is toggled between “Hard” and “Soft”.

By monitoring the transmitting audio signal and visually checking the COMP meter deflection, you can adjust Input Level of Speech Processor to an appropriate compression level, and by visually checking the ALC meter deflection, you can adjust Output Level to an appropriate level.

The graphs below show modulated signal waveforms while the IF speech processor is inactive and if waveforms of modulated signals which are compressed respectively with “Soft” configured or with “Hard” configured.

If there is substantial noise or if it is not easy to distinguish a target signal and noise, adjusting the reference level of the bandscope will facilitate you to distinguish the target signal easily.

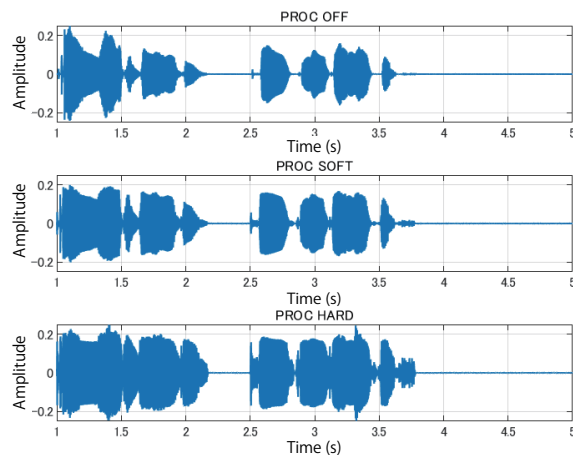

Fig. 58 IF Modulated Signal for Each IF Speech Processor Setting

From the graphs, we can tell that when the IF speech processor is activated, the differences in amplitude are averaged and the talk power is increased.

## Other Functions

### TX/RX Equalizers

The RX equalizer (RX EQ) allows you to easily adjust the quality of the RX audio.

You can select a preferred sound quality from the different preset equalizer curves available and fine-tune the preset curves. Likewise, TX audio characteristics can also be adjusted with the TX equalizer (TX EQ). With this, you can correct the microphone characteristics and also correct it to follow characteristics of your voice.

The volume of each of the 18 bands can be adjusted on the TX Equalizer Adjustment screen and RX Equalizer Adjustment screen. The screens also allow the preset equalizer curves to be customized and the unique equalizer curves to be configured.

Typical audio graphic equalizers divide a spectrum by octave. The equalizers on the TS-890S are designed to divide a spectrum in multiples of 300 Hz. The settings configured on the TX Equalizer Adjustment and RX Equalizer Adjustment screens are immediately applied to the audio, thus enabling fine adjustments while listening to the audio. Customized equalizer settings can be stored in or read from the internal memory or a USB flash drive.

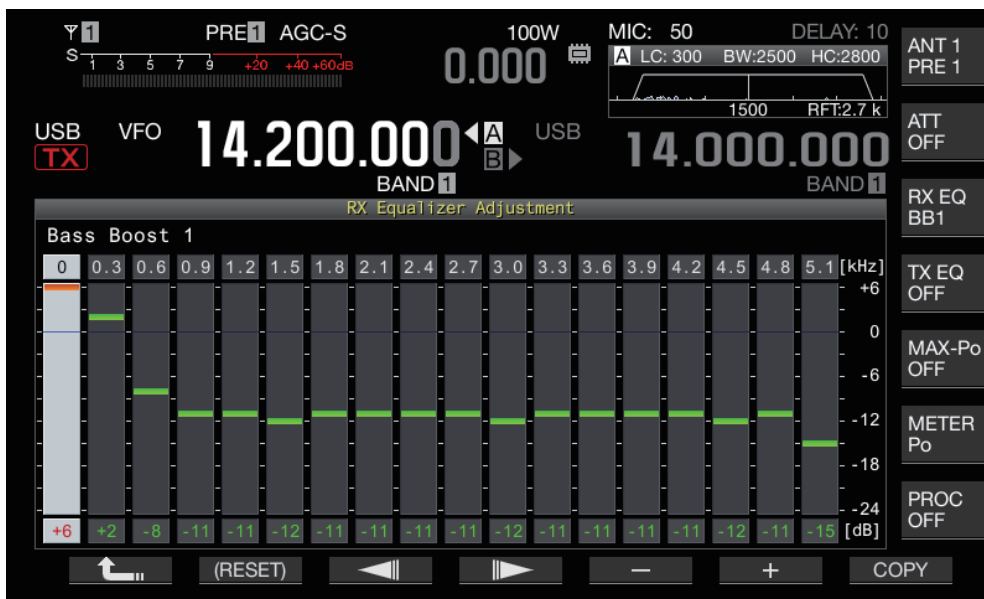

Fig. 59 Customization of Settings on the RX Equalizer Adjustment Screen

### Voice Guidance

The TS-890S comes with a built-in voice guidance function in the DSP which only requires the TS-890S unit to make use of the feature. It is also equipped with a guidance speed control function for controlling the speed via digital signal processing.

# 08 BANDSCOPE

## More User-friendly Bandscope

The FFT (Fast Fourier Transform) bandscope adopted on the TS-990S, which offers outstanding performance in “high spectral display refresh speed” and “adjacent signal discriminability (frequency resolution)”, has become an important feature for more practical use of the transceivers.

To further enhance the practical use of the bandscope on the TS-890S, we have significantly brushed up both processing of signals from the RF unit as well as the software.

### Differences with the TS-990S as an FFT Bandscope

The bandscope of the TS-990S analyzes signals in a 10 kHz frequency width and repeats in this span to obtain a spectral display. This is a suitable method when the bandscope receiver adopts a superheterodyne system. The display refresh speed increases when the span is narrower, while the speed decreases when the span is wider as it takes a longer time to obtain the spectral display for the entire screen.

To achieve high-speed updates to the display irrespective of the span settings, a new IF sampling system has been developed for the TS-890S.

The IF signal for the 8.248 MHz center frequency for down conversion is digitized at a sampling frequency of 39 MHz using a 14-bit A/D converter and converted into I/Q signal via the FPGA digital down converter.

The I/Q signal covers a bandwidth range that is  $\pm 250$  kHz of the maximum span, and the DSP performs calculation of FFT and display spectrum.

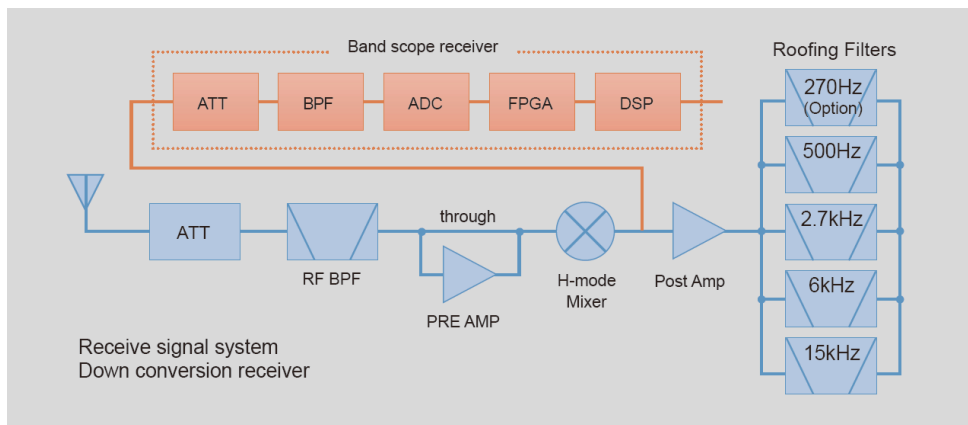

Fig. 60 Configuration of Bandscope Receiver

### 3 Types of Scope Display Modes

The bandscope of the TS-890S offers three different scope display modes.

#### ● Auto Scroll Mode (AUTO SCROLL MODE)

While the display is similar to the Fixed Mode with the lower and upper limits fixed for the displayed frequency, the range of the scope scrolls automatically in this mode when the marker exceeds the lower or upper limit.

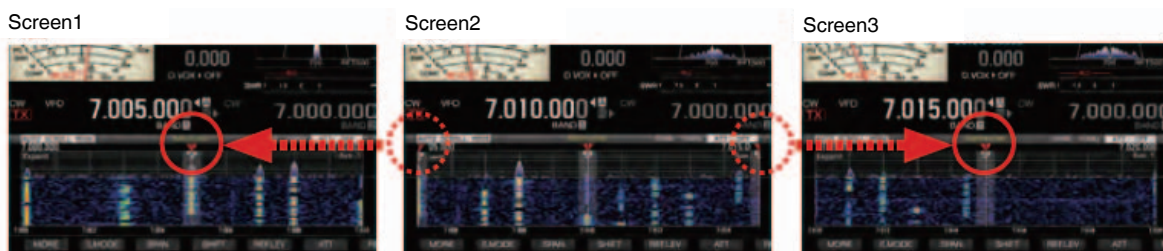

The frequency is made variable on the current screen (Screen 2), and switches automatically to Screen 3 when the marker moves beyond the upper end of Screen 2. Meanwhile, the display switches to Screen 1 when the marker moves beyond the lower end of the screen. Under normal circumstances, the waterfall display is cleared and re-displayed upon switching the display on the screen. However, turning on the EXPAND feature enables a continuous waterfall display without it being cleared every time. The EXPAND feature can be enabled when the span is 200 kHz or lower (the image will appear slightly grainier).

Another new feature on the TS-890S is “Marker Shift”. This is a feature for moving the RX marker to the preconfigured shift position at a single touch. For example, when monitoring the status of other stations calling the DX station or the status within the RX passband such as during FT8 digital communication, the marker shift position can be configured in advance to the left edge of the scope screen and the RX marker can be shifted to this position. Compared to the state when the RX marker is near the center, doing so allows signal monitoring to be performed on a wider area that is to the right of the marker.

### ● Center Mode (CENTER MODE)

The RX frequency is always fixed at the center of the horizontal axis of the bandscope in this mode. The TS-890S adopts a straight-line waterfall display when the frequency is altered. Changing the frequency displaces the flow of the bright lines that indicate the signal intensity horizontally, and tuning is possible by overlapping it with the RX marker. Compared to the conventional follow display, the display in this mode allows for more intuitive tuning. Switching to the follow display is also possible via the menu.

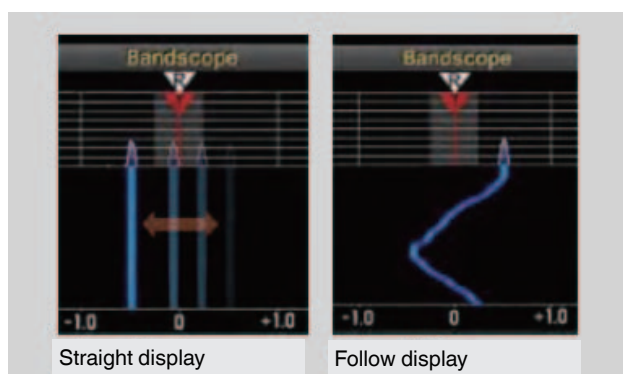

### ● Fixed Mode (FIXED MODE)

The lower and upper limits for the displayed frequency are fixed for each amateur band in this mode. It is possible to switch the scope range to one of the three available options for each amateur band from the panel at a single touch. The default value is preconfigured based on the band plan, but this can be adjusted to the desired range easily.

## Reference Level

Operability of the reference level has been enhanced on the TS-890S with efforts devoted to offer a more user-friendly view of the waterfall display. By optimizing the respective spans, readjustment is almost unnecessary when the span is switched (there will be a slight change in the spectrum height). The reference level can now be configured for each band, and readjustment is no longer necessary when switching between a band for which pairing is ON and one for which pairing is OFF.

## Touchscreen Tuning

When you find a noticeable signal while viewing the bandscope, touch the signal on the bandscope directly.

Doing so moves the display quickly to the area near the target frequency. In the SSB/CW/FSK/PSK mode, correction using the step frequency of the [MULTI/CH] knob is activated to increase the probability of tuning to the target signal (the correction function can also be turned off in the menu). In the CW mode, a long-touch on the screen activates CW auto-tune for more precise tuning.

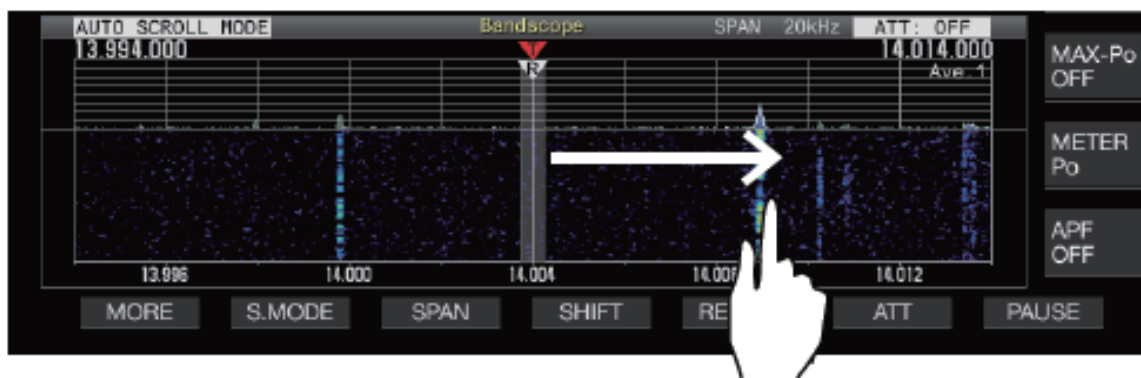

## Gradation Settings

In the waterfall display, the signal intensity is indicated using a color gradation of blue to green (weak), yellow to red (medium) and white (strong). Variation of the color with the signal intensity can be configured in Menu 8-04 "Waterfall Gradation Level". You can adjust the gradation for easier viewing or according to your preferences.

## Tuning Assist Line, Filter Passband Display and Frequency Marker

During operation in the SSB mode, a Tuning Assist Line (yellow) can be displayed at a position that slightly away from the RX frequency marker. Configure the Assist Line to 400 Hz to 500 Hz in the case of voice communication (near the spectral peak frequency of standard human voice) and to the subcarrier frequency in the case of digital communication. Aligning the Assist Line with the point on the spectrum of the waterfall display that has the strongest intensity makes it easier for zeroing-in. The Assist Line can be configured in Menu 8-05 "Tuning Assist Line (SSB Mode)".

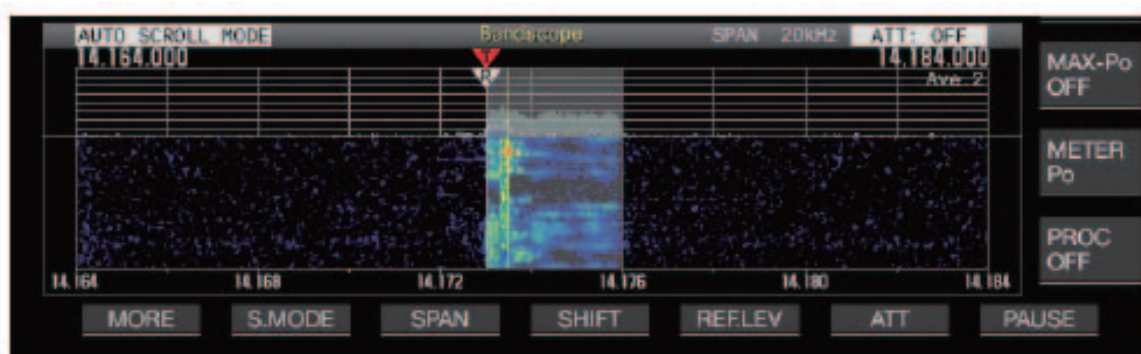

The filter passband appears as a translucent display on the bandscope. Among the signals that are visible within the waterfall area, tuning can be performed easily by turning the main dial to overlap the next signal to receive with this passband display. (The passband in the waterfall area is displayed only when the frequency is altered.)

Besides the RX and TX frequency markers that are constantly displayed, it is also possible to register up to 50 frequency markers which can be displayed at any position. Registering the edge frequency of the band plan or that of the band for use in contests helps to ease identification of the edge frequency on the bandscope.

## Display Function for Actual Operation

The TS-890S has a 7-inch TFT color display, which is the same size as the display size of the top-model TS-990S. The TS-890S also supports a filter scope display, bandscope display, audio scope display, and transmission digital meter, in addition to basic information such as frequency, mode, and S meter. Operations such as contest operation are strongly supported with a variety of displayed contents and good visibility.



### Meter

The type of meter to display on the top-left of the display can be changed according to preference. There is an analog meter type resembling the meters on the TS-930 and TS-940, and a digital meter type which indicates 3 types of information during transmission. Although an analog meter is virtual, because the meter represents the face of the transceiver, we have carefully devised the scale plate that is displayed on the rear panel, the direction and angle of the pilot lamp which illuminates the scale plate, the needles and their shadows, and the glossy texture, etc.



Fig. 61 Analog (White)



Fig. 62 Analog (Black)

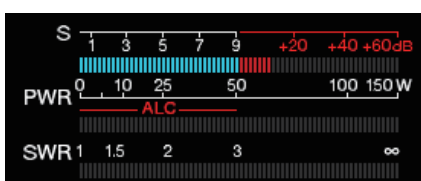

Fig. 63 Digital

Configure the meter type in Menu 0-09 "Meter Display Pattern". The meter type can be quickly switched by touching the meter part of the LCD without entering menu mode.



## Transmission Digital Meter

During transmission, some situations need to be checked not just for the transmit power, but also for the ALC status and the SWR status. In these cases, the methods are selecting the digital meter type for the meter displayed on the top-left, or previously selecting the analog meter type and making the transmission digital meter appear.



The part in the oval in the diagram above is the transmission digital meter. The ALC meter is the top part, and the SWR meter is the bottom part. The meter of the bottom part can be switched such as to the compression meter (during use of the speech processor). At this time, the transmit power is displayed on the analog meter side.

The transmission digital meter is toggled on or off in Menu 0-12 "TX Digital Meter". In addition, the transmission digital meter is not displayed when the meter on the top-left is the digital meter type.

## Filter Scope

The filter scope is on the top-right in the display. The filter scope allows you to check the configuration statuses related to the reception filter (such as the cutoff frequency of the IF filter, the passband width, the bandwidth of the roofing filter, and the CW pitch frequency), and to also confirm the relationship between the target signal and interference signals in the passband by not only listening but also by viewing because the audio signal which passes through the reception filter is displayed as a spectrum.

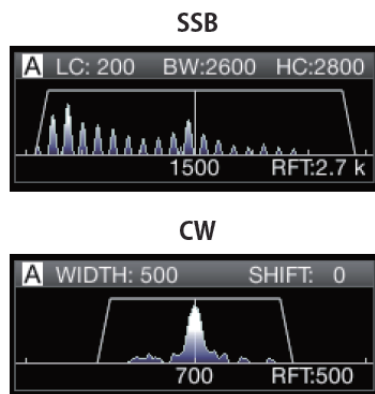

The indication of the notch filter center frequency is added when the notch filter function is on, and the notch frequency can be adjusted with the **[NOTCH]** knob while viewing the status of the interference signal attenuation using the notch filter.



## Operability Improvements for Split Operation

### Split Frequency Configuration By Using the Numeric Keypad

Split operation can easily be configured by using the numeric keypad. For example, to raise by 2 kHz, pressing the numeric key “2” after a long press of the **[SPLIT]** key completes the configuration. With this configuration method, the split frequency can be configured in the range of  $\pm 9$  kHz (in steps of 1 kHz). In addition, the numeric keypad is also used as the band direct key. Numbers are indicated above keys for the ten-key behaviors.

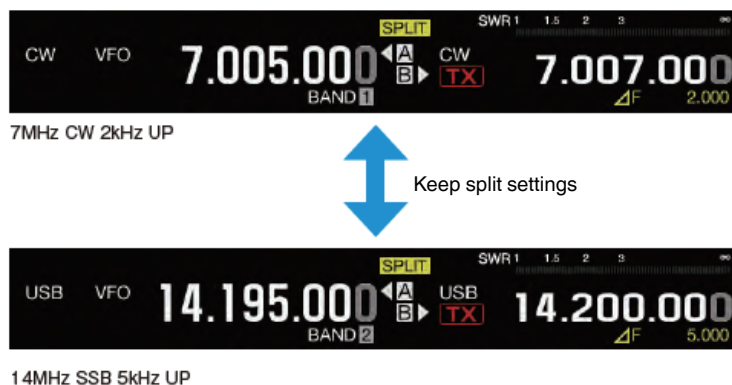

Fig. 64 Band Direct Key

### Band Direct Key Configuration for Split

The TS-890S allows you to switch the band or band memory while retaining the split state when switching the band or band memory by pressing the band direct key during split operation. The configuration is convenient when pursuing a DX-pedition for multi-band/-mode operation because a split frequency and mode can be individually configured to each band memory of each band\*. (\*The default is 3 band memories of each band. The number of band memories can be increased to 5 by using the menu.)

To execute this behavior, select “RX/TX Band” in Menu 3-13 “Band Direct Keys in Split Mode”.



### Split Frequency Change By Using the RIT/XIT Knob

To change the split frequency during split operation, in addition to the method of operating the tuning knob while TF-SET is being executed, the change can now be made by operating the **[RIT/XIT]** knob if RIT/XIT is not being used.

To enable the changing of the split frequency by using the **[RIT/XIT]** knob, configure Menu 3-12 “Split Frequency Offset by RIT/XIT Control”.



## Split Frequency Reception By Using an External Sub Receiver

By connecting another transceiver (TS-890S or TS-590S/ TS-590SG) as a sub receiver, and then using the split transfer A function, the split transmission frequency information is transferred to the sub receiver, and dual band reception can be assisted. The standby behavior to mute the sub receiver during transmission is also supported.

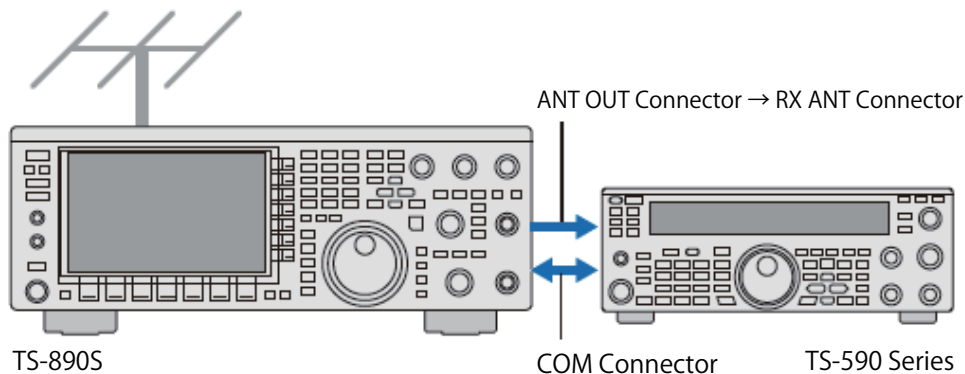

To use the split transfer A function, select “A (TX/RX)” in Menu 7-04 “Quick Data Transfer”, and then select “115200[bps]” in Menu 7-00 “Baud Rate (COM Port)”.

\*When the sub receiver is TS-590S/ TS-590SG, a firmware update is required.

## CW/RTTY/PSK Decoding/Encoding Available Only for the Main Unit

### Decoding/Encoding of CW Morse Code

The TS-890S has a function to display the contents communicated in CW Morse code. Morse transmission can also be done by text entry using a USB keyboard. Use of Morse transmission using fixed phrase transmission by message memory and using a paddle is also available.



For Morse transmission of the text entered from a USB keyboard, turning on the quick mode immediately encodes the entered text. To encode the entered text after the text is confirmed by the text string buffer on the lower screen, turn the quick mode off beforehand, and press [Enter] on a USB keyboard or **F4 [START]** on the main unit to start encoding.

The Morse code entered by using an electronic key or paddle is also converted into text and displayed. By turning the break-in function off beforehand, the TS-890S is also a Morse code practice device.

The TS-890S also has a filter switch dedicated to decoding (Off/Normal/Narrow), a function to send decoded characters to a PC, and a communication log function.

## Decoding/Encoding of RTTY/PSK

The TS-890S is equipped with an internal demodulator and decoder (RTTY supports 170 Hz shift only), allowing RTTY and PSK operations without using a PC. PSK also supports PSK63 (BPSK only). By connecting a USB keyboard, operations can be efficient and comfortable. To operate RTTY by connecting to a PC or other external device (such as an RTTY device or an interface for PC connection) without using the built-in encode/decode function, use the USB port or ACC 2 connector on the rear panel of the transceiver.



Fig. 65 RTTY Communication Screen



Fig. 66 PSK Communication Screen

The encode/decode screen shows an audio spectrum scope which supports tuning. To tune to the target signal, the indication displayed in the scope and the peak of the received signal simply need to match by using the tuning knob.

By touching the audio spectrum scope screen with a finger, the scope switches to the X-Y scope on the RTTY communication screen, and the scope switches to the vector scope on the PSK communication screen. Touch again to return to the spectrum scope.

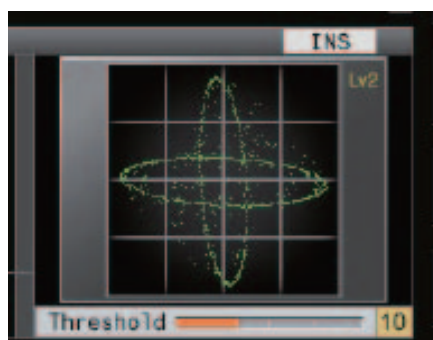

Fig. 67 X-Y Scope (RTTY)



Fig. 68 Vector Scope (PSK)

PSK supports general BPSK, QPSK (excluding PSK63) where error correction can be expected, the AFC function which supports the tuning operation, and the NET function which also changes the transmission frequency based on the AFC.

By using the communication log function, the communication can be stored in the internal memory or a USB flash drive.

## Data Mode Convenient for Operation Using an External Device

As well as a microphone terminal, the rear panel has a variety of input and output interfaces such as an analog audio input and output, a USB audio interface, and a LAN (VoIP) interface. The demodulation path by a combination with DATA mode in each mode of SSB/FM/AM is free to be configured. Also, transmission by a modulated signal from a PC becomes available by using DATA VOX at the same time, and the wiring and commands to standby are not required.

### Switching the Input Sound Source

The sound source to be transmitted by using the [PTT] or [SEND] key and the sound source to be transmitted by the PKS signal of the rear panel ACC 2 connector or by using the [DATA SEND] key assigned to a [PF] key can be switched as required. They can each be configured as OFF/ON in DATA mode.

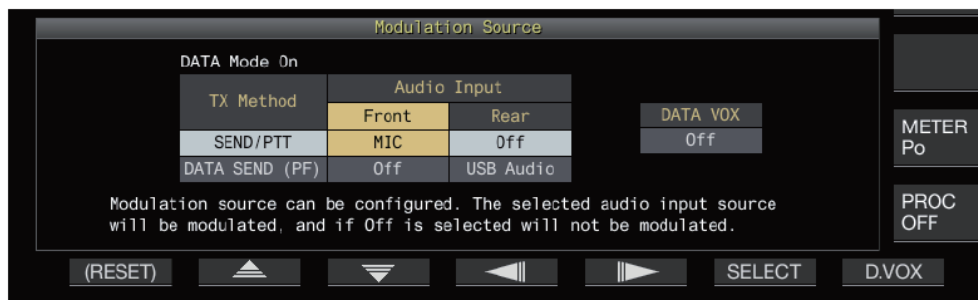

The image above is a configuration example of when DATA mode is ON. The microphone input audio is selected as the sound source of when transmission is by using the [SEND] key or [PTT], and the input audio from the rear panel connector is blocked. For the sound source of when transmission is by the PKS signal of the rear panel ACC 2 connector or by using the [DATA SEND] key assigned to a [PF] key, the USB audio from the USB connector is selected, and the microphone input audio is blocked.

In addition, this screen appears by pressing and holding the [DATA] key. Pressing and holding the [DATA] key while DATA mode is ON enables the behavior configuration of when DATA mode is ON, and pressing and holding the [DATA] key while DATA mode is OFF enables the behavior configuration of when DATA mode is OFF.

The VOX behavior (DATA VOX) by the audio input from the rear panel connector is also configured on this screen.

## USB Keying

The TS-890S supports PC applications which control each behavior for CW keying, RTTY frequency shift, and PTT/SEND (switching of transmitting and receiving) by using the RTS/DTR signal of the COM port. Each behavior can be assigned to the RTS signal and DTR signal of the 2 virtual COM ports (Standard and Enhanced) which can be used when the TS-890S is connected to a PC by using a USB cable.

Configure by using the following advanced menu items:

Advanced Menu	Item Name
17	Virtual Standard COM Port-RTS
18	Virtual Standard COM Port-DTR
19	Virtual Enhanced COM Port-RTS
20	Virtual Enhanced COM Port-DTR

Option	Behavior
Off	Does not work.
Flow Control	Behaves as the hardware flow control signal of command communications. (Advanced Menu 17 only)
CW Keying	Behaves as the CW keying signal.
RTTY Keying	Behaves as the RTTY frequency shift keying signal.
PTT	Behaves the same as PTT (SEND).
DATA SEND	Behaves the same as DATA SEND (PKS).

## Functions Related to the Internal Memory/USB Flash Drive/File Management

The TS-890S can save the following data in the internal memory or USB flash drive:

- Transceiver configuration data
- TX equalizer/RX equalizer configuration data
- Manual recording/constant recording audio data
- Timed recording audio data
- Screen capture image data (save only, cannot be displayed on the transceiver)
- Each CW/RTTY/PSK communication log data
- KNS communication log data (save only, cannot be displayed on the transceiver)

## Selection of Data Storage Location

By default, the transceiver saves in the internal memory (the maximum storage space is 1 GB). The transceiver can save in the USB flash drive connected to the transceiver by changing the configuration.

The storage location is changed in “File Storage Location” of the “USB/File Management” menu. To activate the “USB/File Management” menu, press **F[USB/FILE]** after **[MENU]** key is pressed to open the menu screen.

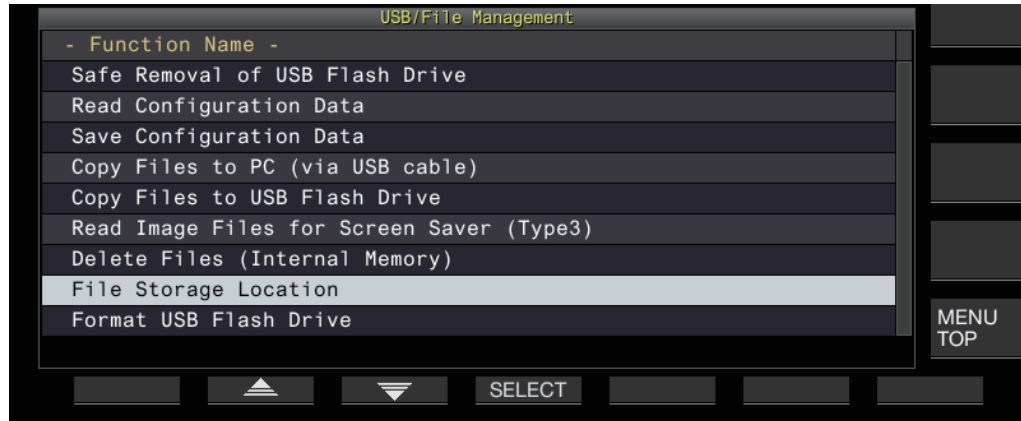

In addition, when removing the USB flash drive, always execute the “Safe Removal of USB Flash Drive” operation (select “Safe Removal of USB Flash Drive” in the “USB/File Management” menu above).

## Storage and Reading of Configuration Data

Data configured in the transceiver can be stored in a file as configuration data. The configuration that was stored can be restored by reading the data in the stored file.

When reading, the reading of the configuration data which depends on the placement environment such as the LAN configuration and the configuration related to the rear panel connector can be excluded.

## Copying from the Internal Memory to the USB Flash Drive

The data stored in the internal memory can be copied to a USB flash drive.

Select “Copy Files to USB Flash Drive” from the “USB/File Management” menu to open the screen to select the target for copying.



Press **F4 [OK]** after the item to copy is selected here to copy the file included in the selected item to the appropriate folder of the USB flash drive.

## Copying from the Internal Memory to a PC

The data stored in the internal memory can be copied to (imported into) a PC.

Select “Copy Files to PC (via USB cable)” from the “USB/File Management” menu to open the screen to select the target for copying. Press **F4 [OK]** after the item to copy is selected to display the following screen:

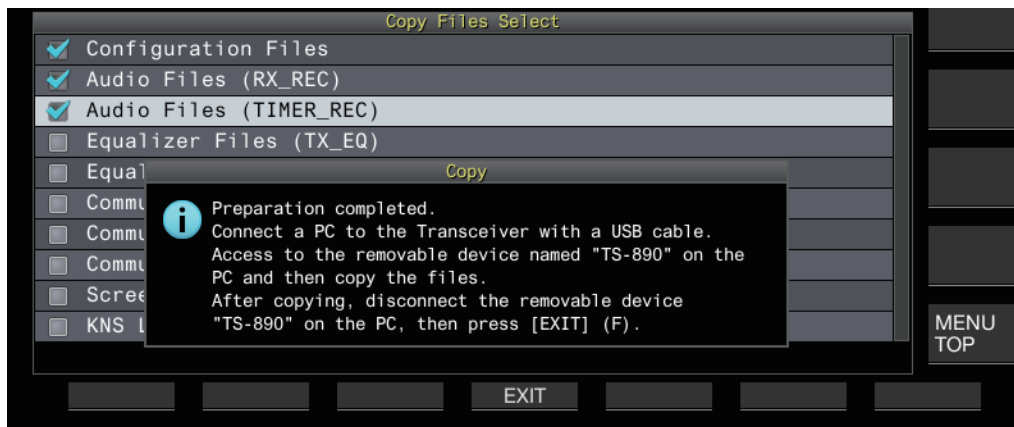

When this screen is displayed, “TS-890S” appears as a removable device on the Explorer of the PC connected to the TS-890S by using a USB cable.

Access “TS-890S” of the removable device on the Explorer to copy required files to the PC.

After copying is complete, carefully remove the removable device “TS-890S” by using the PC, and then press **F4 [EXIT]** on the transceiver.

## Configuring the Images to be Used in the Screen Saver

The TS-890S can display your preferred photographs and images in the slideshow format by using the screen saver function.

To configure, first copy the images to display to the “KENWOOD\TS-890\IMAGE” folder of a USB flash drive by using a PC. Select “Read Image Files for Screen Saver (Type 3)” in the “USB/File Management” menu after mounting the USB flash drive on the TS-890S, and then copy the images to the internal memory in the transceiver.

\*The image file which can be used in the screen saver is an image file of the jpg or jpeg extension and 2.0 megapixels (1920 x 1080 pixels) or less.

To make the screen saver which uses images copied to the transceiver behave, select “Type 3” in Menu 0-03 “Screen Saver”. Also, configure the duration of time until the screen saver is activated in Menu 0-04 “Screen Saver Wait Time”. The screen saver activates when the configured duration of time elapses without any operation.



## Other Useful Functions

### Audio Scope

In the audio scope, the received and transmitted audio signals are displayed in the frequency spectrum and oscilloscope waveform. The effects of applying the various equalizers and the effects of using the speech processors can be observed. The audio scope can be used with the minimized bandscope at the same time.

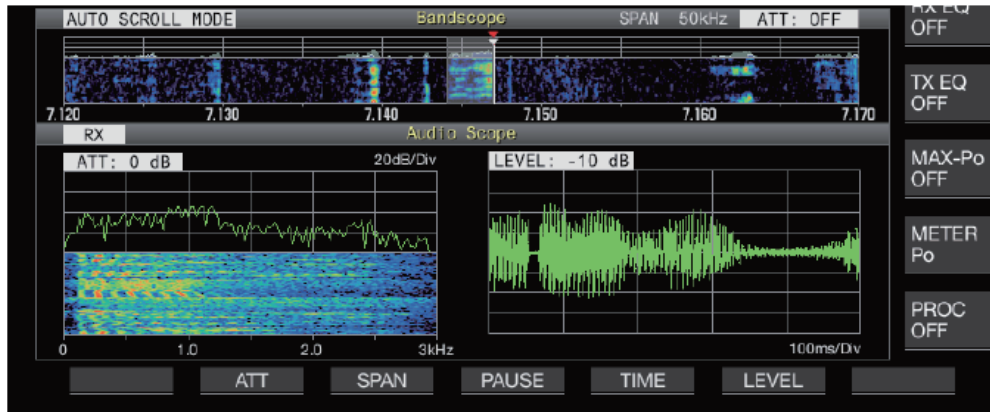

### Recording Function

The constant recording function is convenient such as when you missed hearing the callsign or when you are not confident in a callback. Pressing and holding the [●(Red)] key saves the latest communication for up to 30 seconds into an audio file, and you can listen to it again later.

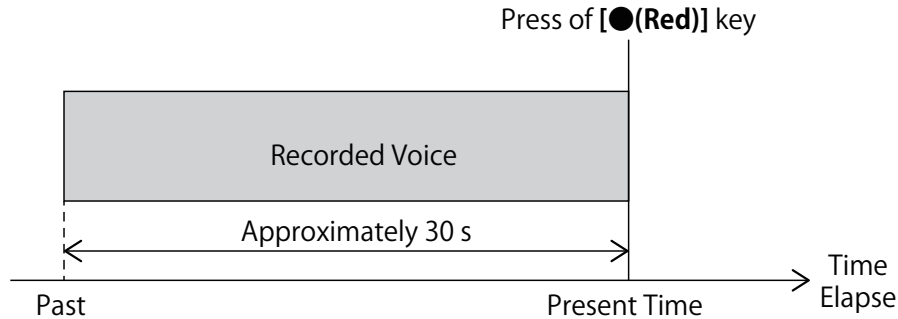

Fig. 69 Recording with a Long Press of the [●(Red)] Key (Constant Recording)

The recording function can also be used as a general-use recorder. For recording and playing back by a press of the [●(Red)] key and [■] key, the internal memory of the main unit or a USB flash drive can be used. With the internal memory of the main unit, a maximum of 9 hours\* of recording is possible in one file, and with a USB flash drive, a maximum of 18 hours of the long-time recording is possible in one file.

\*Because the internal memory is used in common for other functions, the available recording time varies depending on the free space at the time.

### Clock Setting Function that uses an NTP Server

Connecting the TS-890S to a network enables the clock setting using an NTP server. If an NTP server is specified once, the clock can be adjusted by a single touch. Enabling the automatic time correction function automatically corrects the clock when the power is on and approximately every 24 hours after the power is on.

In addition, the clock setting by using an NTP server is also available when the ARCP-890 is connected through a LAN.

## Transverse Dial Display in SWL Mode

You can enjoy the reception of short wave broadcasting with a transverse dial display resembling that on the classic showpiece 9R-59.

The receivable frequency range of the TS-890S is different from that of the 9R-59. Thus, the scale of the transverse dial display is arranged to match the specification of the TS-890S. The “band-spread display”, which was required on the original 9R-59, is not available; however, the design of the realistically reproduced vertical S-meter and “MEGACYCLE” notations, etc. will evoke memories of transceivers from those days.

\*Transmission is not available in SWL mode.

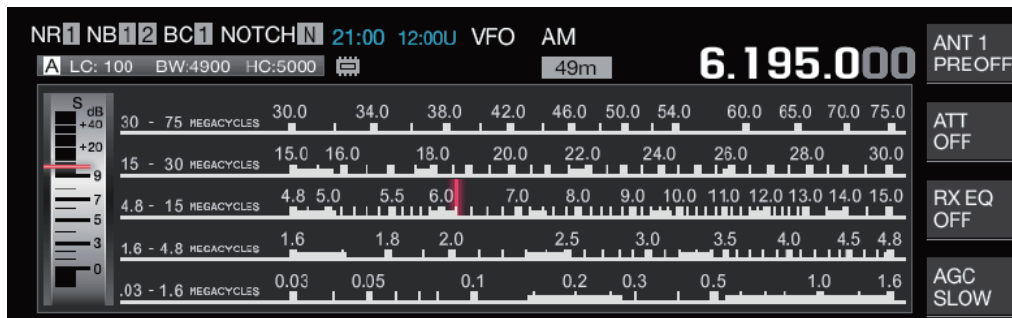

## Firmware Updating

The firmware of the TS-890S can easily be updated by using a USB flash drive or a PC. The latest firmware information is provided on the JVC KENWOOD website.

There are two firmware updating methods available:

### ● Using a USB Flash Drive

- Copy into a USB flash drive the firmware file downloaded from the JVC KENWOOD website. (Copy the firmware file into the root folder of the USB flash drive, keeping it compressed.)
- Turn the TS-890S on while pressing and holding [M.IN], and connect a USB flash drive with the firmware file stored.
- The update starts automatically, and wait until the update completes.
- Turn off and on again the power switch on the front panel after the update completes.

### ● Transferring from a PC Connected with a USB Cable

- Download the firmware file from the JVC KENWOOD website to the desktop, etc. of a PC.
- Connect the USB connector on the rear panel of the TS-890S and a PC by using a USB cable.
- Turn the TS-890S on while pressing and holding [M.IN].
- After a short time, “TS-890S” appears as a removable device on the Explorer of a PC.
- Drag and drop the firmware file to the removable device “TS-890S”. (Drag and drop the firmware file, keeping it compressed.)
- The update starts automatically, and wait until the update completes.
- Turn off and on again the power switch on the front panel after the update completes.

## PC-Control

The freeware ARCP-890 is available as a radio control program dedicated to the TS-890S, and the PC command reference guide is openly available, and we suggest trying a self-programmed application for your own purpose.

The following are the descriptions for a self-programmed application and some instructions and tips for the PC commands

### ● Descriptions for Programming the PC Application

To make an application using the PC commands, the COM serial communication is generally used after connecting the transceiver and a PC with an RS-232C cable or a USB cable. To make a serial communication, the serial port class, etc. (depends on the programming language used) is used for the PC application. The basic contents to program are as follows:

- Opening a serial port (COM port)
- Configuring the communication parameters such as the baud rate and the number of bits (Refer to page 1 of the PC command reference guide for the communication parameter configuration.)
- Writing the transmission data to the transmission buffer of the serial port
- Reading the reception data from the reception buffer of the serial port
- Closing (disconnecting) the serial port

### ● Program for Sending Commands

To send a command to the transceiver, the command to send needs to be written one byte at a time to the transmission buffer of the serial port. Refer to the PC command reference guide for the commands. A semicolon (;) is always needed at the termination of the command.

If the configured command is sent properly, the transceiver status changes. If the read command is sent properly, the response command is returned from the transceiver

### ● Program for Receiving Commands

To receive a command by the transceiver, the buffer for reading a command needs to be prepared to read the data to the buffer one byte at a time from the reception buffer of the serial port. If the read data has a semicolon (;), the reception of the command completes, and the received content will be analyzed.

### ● Configuring and Reading the VFO Frequency

To configure and read the VFO A frequency, the FA command is used. To configure and read the VFO B frequency, the FB command is used.

### ● Distinguishing between the Receive VFO and the Transmit VFO, Distinguishing between Simplex and Split

By using the read command of the FR command and FT command, you can distinguish which of VFO A and VFO B is the receive frequency and which is the transmit frequency.

To know which VFO is the receive frequency, send "FR;" from the PC application. If "FR0;" is returned from the transceiver, VFO A is the receive frequency. If "FR1;" is returned, VFO B is the receive frequency.

To know which VFO is the transmit frequency, send "FT;" from the PC application. If "FT0;" is returned from the transceiver, VFO A is the transmit frequency. If "FT1;" is returned, VFO B is the transmit frequency.

If the numbers of the parameters of the FR command and FT command returned from the transceiver are the same, that means the transceiver is in the simplex operation, and if they are different, that means the transceiver is in the split operation.

By using the configured commands of the FR command and FT command, the same operation as using the [A/B] key and [SPLIT] key can be remotely controlled from the PC application with the combination of the commands.

### ● Configuring and Reading the Mode

To switch the mode such as USB, LSB, and CW, or to read the current mode, the OM command is used.

For example, if “OM03;” is sent to the transceiver, CW is configured as the receive mode (for simplex, the same mode is configured for the transmit mode).

For split, to configure CW as the transmit mode for example, “OM13;” needs to be sent. If the number that follows OM is 0, the receive mode is the target to configure or read, and if the number that follows OM is 1, the transmit mode is the target to configure or read.

### ● Acquiring the Transceiver Status Changes (Operating Frequencies, etc.) in Real Time

The Auto Information (AI) function is used.

Activating the Auto Information function by executing the AI command notifies the PC of the TS-890S status changes in real time.

For example, upon a change of the VFO A frequency, the latest VFO A frequency is automatically notified with the FA command, and upon a change of the VFO B frequency, the latest VFO B frequency is automatically notified with the FB command. It is not necessary to check the status from the PC application periodically.

Not only the frequency information but also almost all of the change information, such as the selected modes and filters and the configuration status of the transmit power, is notified with the corresponding commands in real time. In a self-programmed PC application, use only required commands from among these notified commands.

To use only required commands, slightly advanced programming is needed. Only the tips are introduced here.

A semicolon (;) always exists at the termination of the command. If the semicolon is received, the data to be received next is a new command data. Because the first 2 to 3 digits are the command part (the rest is the parameter), check the command part.

For example, if you need only the VFO A and VFO B frequency information, analyze the parameters that follow afterward only when the first two digits are “FA” or “FB”. If they are not “FA” or “FB”, ignore all of the data to be received afterward. However, at least check whether a semicolon is received every time. If a semicolon is received, return to the first process. This procedure is repeated thereafter.

In addition, the Auto Information function may notify a number of commands all at once to a PC; hence, you should manage whether the self-programmed PC application has the sufficient buffer memory size to receive commands. Also, caution is required, such as not using an old PC with low processing speed.

### ● How to Acquire the Bandscope Spectrum Information

The DD2 command or DD4 command is used.

The DD2 command notifies the PC of the spectrum information approximately once a second by using the above Auto Information function. The 640 pieces of spectrum information per screen are notified by dividing them over 32 times.

The DD4 command does not use the Auto Information function and instead notifies the PC of the spectrum information at approximately 3 times the rate of the DD2 command (approximately 3 times a second). The DD4 command also notifies the information about the scope display mode, the lower-limit frequency and the upper-limit frequency of the scope, or the span frequency required for a self-programmed application.

## KNS Operation without using the Host PC

For the TS-890S series, the remote control through a LAN or the Internet is available by using the radio control program ARCP-890 and KENWOOD NETWORK COMMAND SYSTEM (KNS).

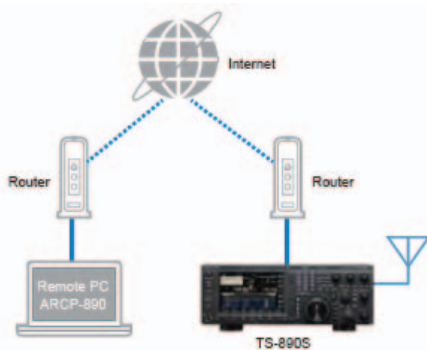

Fig. 70 Remote Control through the Internet

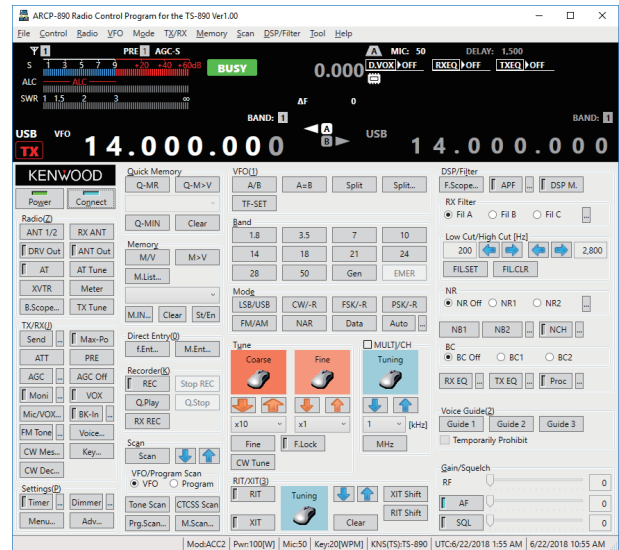

Fig. 71 ARCP-890

In the KNS operation, the control command data communication and the audio data communication are done between the TS-890S and ARCP-890 by using a LAN or the Internet. The audio data communication is done with the VoIP function available in the TS-890S and ARCP-890, and the received audio of the TS-890S can be heard from a PC speaker. The audio input from a PC microphone can also be sent from the TS-890S.

Displaying the bandscope on the ARCP-890 is also possible. The bandscope with a display speed equal to or higher than that of the TS-890S can also be used on the ARCP-890.

In this bandscope screen, the ratio of the spectrum scope display to the waterfall display can be freely be changed. Also, the same operation as touch tuning of the main unit by clicking the mouse (left-clicking: short-press touch, right-clicking: long-press touch) can be done.

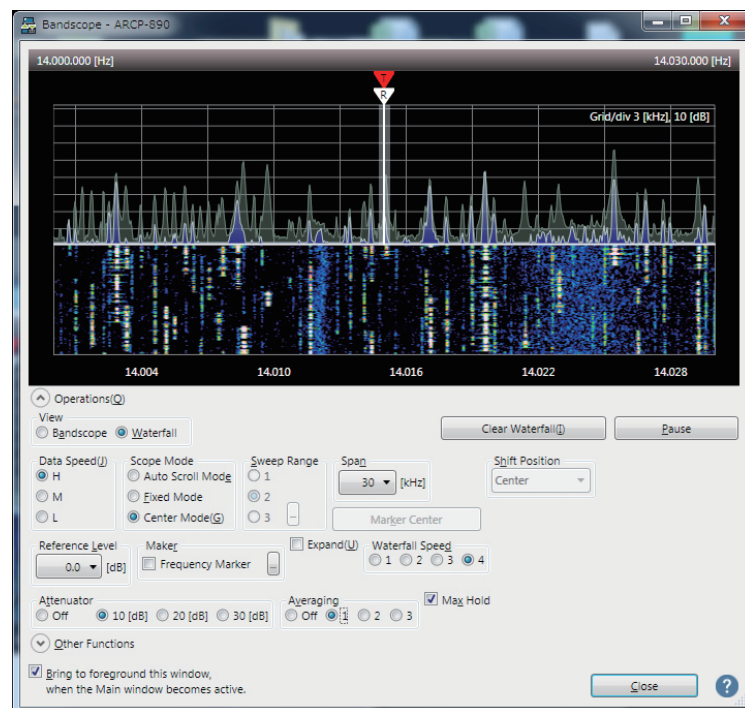

Fig. 72 Bandscope Display on the ARCP-890

## 09 SOFTWARE

The conventional system, where the TS-890S is connected to the Internet via a PC (host PC) placed at the host station, can also be selected. In this conventional system, the ARHP-890 (radio host program) and the ARVP-10 (VoIP software) are required.

Refer to “TS-890S KENWOOD NETWORK COMMAND SYSTEM Setting Manual” which describes detailed information on the configuration method for remote control.

The software for remotely controlling ARCP-890, etc. and “TS-890S KENWOOD NETWORK COMMAND SYSTEM Setting Manual” can be downloaded from the following URL:

[https://www.kenwood.com/i/products/info/amateur/software\\_download.html](https://www.kenwood.com/i/products/info/amateur/software_download.html)

## Windows Software

This is a description of the Windows software used to control the TS-890S from a PC.

The following Windows software which can be used for the TS-890S is available:

Name	Description
ARCP-890	This is software that controls the TS-890S from the PC.
ARHP-890	This is the host program used on the host station PC to remotely control the TS-890S through a network. This is used with the ARCP-890. (This is used when the internal TS-890S KNS server function is not used.)
ARVP-10	This is the VoIP software to send TX/RX audio when the TS-890S is remotely controlled through a network. (There are two types of ARVP-10: the ARVP-10H and ARVP-10R.) (This is used when the internal TS-890S VoIP is not used.)
ARUA-10	This is software to substitute the microphone and speaker of the PC for a microphone and speaker of the TS-890S when the connection is a USB connection. The output audio of the TS-890S can sound from the PC speaker through the USB audio. Also, the audio input to the PC microphone can be transmitted from the TS-890S through the USB audio. (This software is not used when a user-made audio cable is connected from the ACC 2 connector.) (This software is not used to remotely control through a network.)
Virtual COM Port Driver	This is software allowing you to use the ARCP-890 and ARHP-890 by installing the software in the PC and connecting the TS-890S to a PC with a USB cable. (This software is not used when a serial or LAN cable is connected.)

## System Configurations

The typical system configurations that use the TS-890S and Windows software are described below.

Refer to “TS-890S KENWOOD NETWORK COMMAND SYSTEM Setting Manual” which describes detailed information on the configuration method for remote control.

### ■ Controlling the TS-890S from an Adjacently-placed PC (with a Microphone Connected to the TS-890S and an Internal Speaker)

#### ● Using the LAN connector

Signal Type	PC		Connection Method	TS-890S
	Software	Hardware		Hardware
Control signal	ARCP-890	-	LAN Cable	Connect to the <b>LAN</b> connector
Audio signal	-	-	No connection	Microphone connected to the TS-890S and internal speaker

**Note:**

- ◆ Configure “On (LAN)” in “KNS Operation (LAN Connector)” of the TS-890S.

#### ● Using the USB connector

Signal Type	PC		Connection Method	TS-890S
	Software	Hardware		Hardware
Control signal	Virtual COM port driver and ARCP-890	-	USB cable	Connect to the <b>USB-B</b> connector.
Audio signal	-	-	No connection	Microphone connected to the TS-890S and internal speaker

**Note:**

- ◆ With these system configurations, the bandscope screen refreshes at a slower speed.

#### ● Using the COM connector

Signal Type	PC		Connection Method	TS-890S
	Software	Hardware		Hardware
Control signal	ARCP-890	-	RS-232C cable	Connect to the <b>COM</b> connector.
Audio signal	-	-	No connection	Microphone connected to the TS-890S and internal speaker

**Note:**

- ◆ With these system configurations, the bandscope screen refreshes at a slower speed

## ■ Controlling the TS-890S from an Adjacenty-placed PC (with a Microphone and Speaker Connected to the PC )

### ● Using the LAN connector

Signal Type	PC		Connection Method	TS-890S
	Software	Hardware		Hardware
Control signal	ARCP-890	-	LAN Cable	Connect to the <b>LAN</b> connector.
Audio signal	ARCP-890 and Windows sound driver	Microphone and speaker connected to a PC		

**Note:**

- ◆ Configure “On (LAN)” in “KNS Operation (LAN Connector)” of the TS-890S

### ● Using the USB connector

Signal Type	PC		Connection Method	TS-890S
	Software	Hardware		Hardware
Control signal	Virtual COM port driver and ARCP-890	-	USB cable	Connect to the <b>USB-B</b> connector.
Audio signal	ARUA-10 and Windows sound driver	Microphone and speaker connected to a PC	-	-

**Note:**

- ◆ With these system configurations, the bandscope screen refreshes at a slower speed.

### ● Using the COM connector and ACC 2 connector

Signal Type	PC		Connection Method	TS-890S
	Software	Hardware		Hardware
Control signal	ARCP-890	-	RS-232C cable	Connect to the <b>COM</b> connector.
Audio signal	-	Microphone and speaker connected to a PC	User-made audio cable	Connect to the <b>ACC 2</b> connector.

**Note:**

- ◆ With these system configurations, the bandscope screen refreshes at a slower speed.
- ◆ When the ACC 2 connector is used for audio signal I/O, the ARUA-10 is not used.



## ■ Controlling the TS-890S from a Remotely-placed PC

### ● System configurations that are configured by using the ARCP-890 and TS-890S

Signal Type	PC		Connection Method	Host Station(TS-890S)	
	Software	Hardware		Software	Hardware
Control signal	ARCP-890	-	Network	-	Connect to the LAN connector.
Audio signal	ARCP-890 and Windows sound driver	Microphone and speaker connected to a PC			

**Note:**

- ◆ Configure "On (Internet)" in "KNS Operation (LAN Connector)" of the TS-890S.

### ● System configurations that are configured by using the ARCP-890, ARHP-890, and TS-890S (for the KNS connection via LAN)

Signal Type	PC		Connection Method	Host Station(PC placed on the TS-890S side)	
	Software	Hardware		Software	Hardware
Control signal	ARCP-890	-	Network	-	Connect to the LAN connector.
Audio signal	ARCP-890 and Windows sound driver	Microphone and speaker connected to a PC		ARHP-890	

**Note:**

- ◆ Configure "On (Internet)" in "KNS Operation (LAN Connector)" of the TS-890S.

### ● System configurations that are configured by using the ARCP-890, ARHP-890, ARVP-10, and TS-890S (for the KNS connection via Internet)

Signal Type	Remote Station (Remote PC)		Connection Method	Host Station(PC placed on the TS-890S side)	
	Software	Hardware		Software	Hardware
Control signal	ARCP-890	-	Network	ARHP-890	Connect to the LAN connector, <b>USB-B</b> connector, or <b>COM</b> connector.
Audio signal	ARVP-10R or general VoIP software	Microphone and speaker connected to a PC		ARVP-10H or general VoIP software	Connect to the <b>ACC 2</b> connector or <b>USB-B</b> connector.

**Note:**

- ◆ Configure "On (Internet)" in "KNS Operation (LAN Connector)" of the TS-890S.
- ◆ When the ARHP-890 and TS-890S are connected by a USB-B connector or **COM** connector, the bandscope screen refreshes at a slower speed.
- ◆ Even when the **USB-B** connector is used for audio signal I/O on the host station side, the ARUA-10 is not used

## New Option ARCP-890 (Radio Control Program for TS-890S) (Free Software Application)

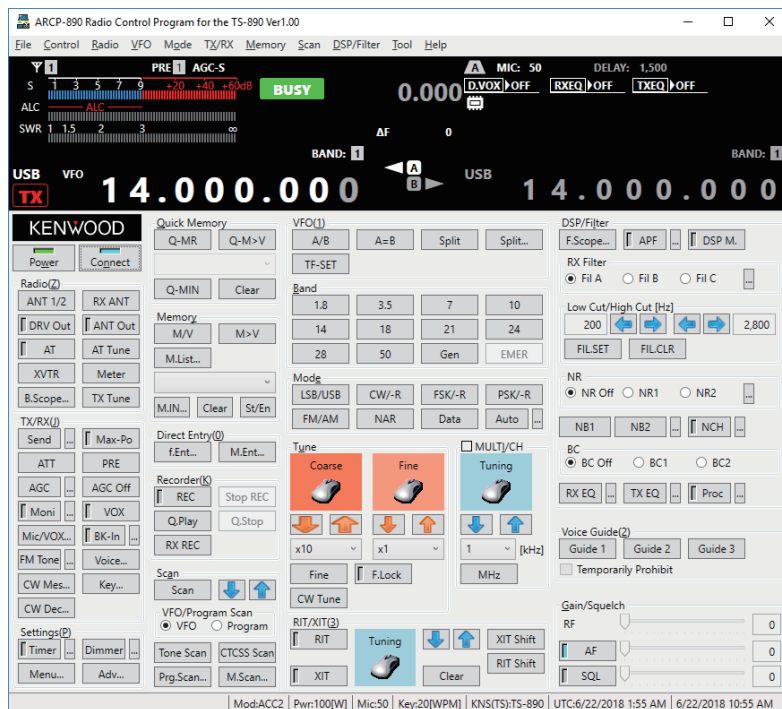

The ARCP-890 is the software to control the TS-890S from a PC.

The ARCP-890 is a free software application and can be downloaded free of charge from the KENWOOD website.

KENWOOD website:

[https://www.kenwood.com/i/products/info/amateur/software\\_download.html](https://www.kenwood.com/i/products/info/amateur/software_download.html)

### Basic Specifications Inherited from the ARCP-990

The ARCP-890, equivalent to the ARCP-990 for the TS-990S, is designed to be able to operate most of the TS-890S functions. Furthermore, it also conforms to the new CW functions of the TS-890S.

### User Interface

The ARCP-890 has its user interface languages in both Japanese and English. The ARCP-890 is operable in the language more familiar to the user.

Font change of the user interface is supported in the ARCP-890. Select “Configure Font” from the “Tool” pulldown menu, and then configure the settings on the “Configure Font” screen.

The number of parts on the main screen has increased with the increase in the number of TS-890S functions; hence, a display of SXGA (1280 x 1024) or higher resolution is required. However, changing the size of the main screen is now supported for use even on a small-sized notebook PC, etc. To change the main screen size, select “Size of Main Window” from the “Tool” pulldown menu, or use the resize grip on the lower right side of the main screen.

For quick access from the main screen to the configuration sub screen, the “...” button for accessing the configuration sub screen of the function is now available close to the function button. For example, the “Configure AGC” configuration sub screen can be accessed by using the “...” button placed on the right of the AGC button which is on the left center of the main screen.

With the increase in the number of TS-890S functions, the number of sub screens for the configurations have increased.

For quick access to the related functions, the “Other Functions” hyperlink to access the related functions is provided at the bottom of the configuration sub screen.

## New Option ARHP-890 (Radio Host Program) (Free Software Application)

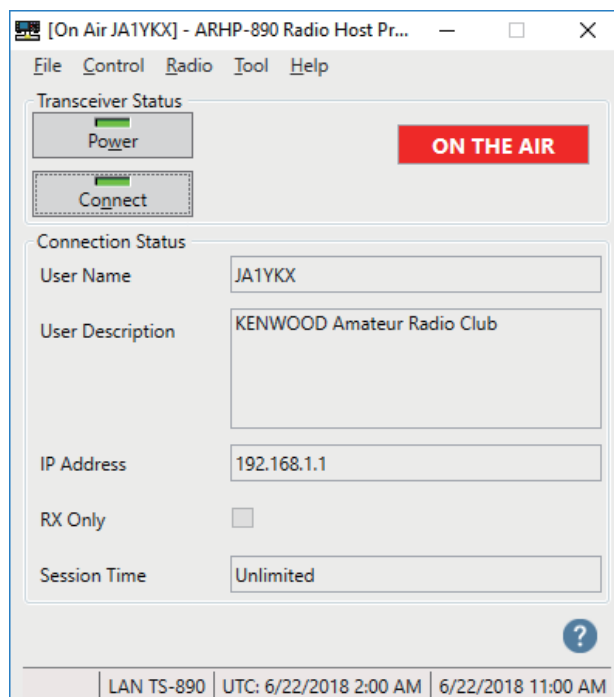

The ARHP-890 is the KNS host software to operate TS-890S in the KNS operation.

This is used when the internal TS-890S KNS server function is not used.

The ARHP-890 is a free software application and can be downloaded free of charge from the KENWOOD website.

Refer to “TS-890S KENWOOD NETWORK COMMAND SYSTEM Setting Manual” which describes detailed information on the configuration method for remote control.

### Basic Specifications Inherited from the ARHP-990

The ARHP-890 inherits the basic specifications of the ARHP-990 developed for the TS-990S.

### User Interface

The ARHP-890 has its user interface languages in both Japanese and English. The ARHP-890 is operable with the language more familiar to the user.

The ARHP-890 supports the configuration for whether to permit only reception for each user. Select “Configure KNS” from the “Tool” pulldown menu, and then configure the settings in the “Configure KNS User” screen after selecting the “Configure KNS User” button on the “Configure KNS” screen

## ARUA-10 (USB Audio Controller) (Free Software Application)

The ARUA-10, a software application for the USB audio control to substitute a microphone and speaker connected to a PC for a microphone and speaker of the TS-890S when the TS-890S is connected to the PC by using a USB cable, has been released.

The ARUA-10 is a free software application and can be downloaded free of charge from the KENWOOD website.

Refer also to “TS-890S USB Audio Setting Manual” distributed on the KENWOOD website.

### Caution:

- ◆ For USB audio, a time delay is unavoidable due to its operating principle. Thus, it cannot be used in a case when the delay may cause a problem in operation (for example, when quick responses are required in a contest or pileup)
- ◆ If a KNS operation is done with a network connection, no ARUA-10 is used.

## Basic Functions

When using the combination of the ARUA-10 and the ARCP-890, by simply connecting the TS-890S and a PC with a single USB cable, the transceiver can be controlled from the PC and a microphone and speaker connected to the PC can be substituted for the microphone and speaker of the TS-890S.

To use the ARCP-890 with a USB cable connection, the virtual COM port driver needs to be installed.

To use only the ARUA-10 with a USB cable connection, a virtual COM port driver does not need to be installed. To use the USB sound function implemented in the TS-890S, TS-890S functions with the Windows sound drive.

## Behavior

The ARUA-10 serves as a bridge between the USB sound function (USB audio device) built into the TS-890S and the sound device on a PC for the microphone and speaker control.

An audio signal input into the microphone of the PC is input to the modulation input of the USB audio device in the TS-890S.

The audio signal output from the RX output of the USB audio device in the TS-890S is output to the speaker of the PC.

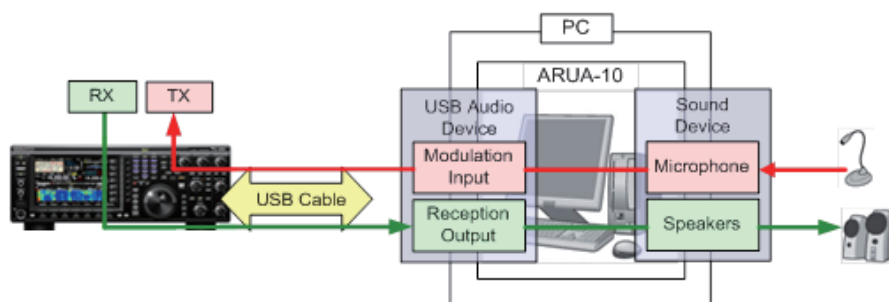

Fig. 73 Example of the ARUA-10 and Peripheral Connections

## ARVP-10H/ARVP-10R (Radio VoIP Program) (Free Software Application)

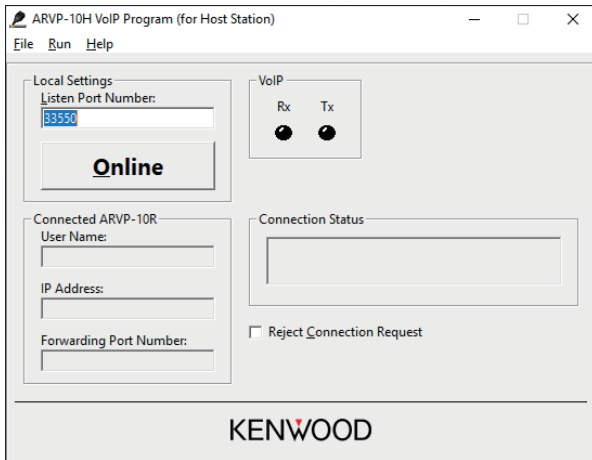

Fig. 74 ARVP-10H Main Window (for Host Station)

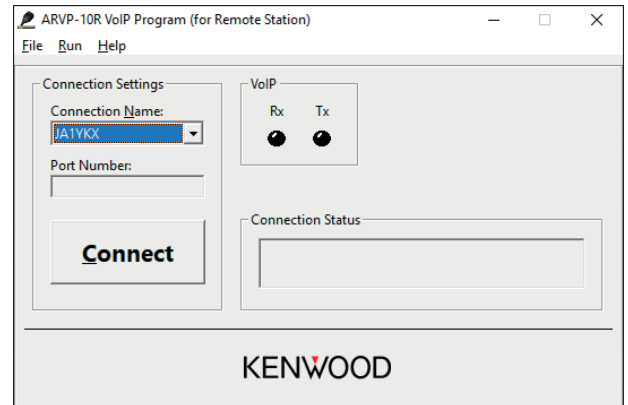

Fig. 75 ARVP-10R Main Window (for Remote Station)

There are two software applications released to divert the audio signal with the network connection: the ARVP-10H, which provides the VoIP function on the host station site where the TS-890S is placed, and the ARVP-10R, which provides the VoIP function on the remote station site that remotely controls the TS-890S.

The ARVP-10H and ARVP-10R are free software applications and can be downloaded free of charge from the KENWOOD website.

Refer to “TS-890S KENWOOD NETWORK COMMAND SYSTEM Setting Manual” which describes detailed information on the configuration method for remote control.

### Basic Functions

The ARVP-10H and ARVP-10R enable an audio signal to be sent and received through a network

## Virtual COM Port Driver

To use the ARCP-890 or ARHP-890 through a USB connection, or to use other application software which control the TS-890S through the RS-232C, a virtual COM port driver needs to be installed.

A virtual COM port driver is a free software application and can be downloaded free of charge from the KENWOOD website.

For a connection through an RS-232C cable or through a LAN cable, a virtual COM port driver does not need to be installed.

To use only the ARUA-10 with a USB cable connection, a virtual COM port driver does not need to be installed. To use the USB sound function implemented in the TS-890S, TS-890S functions with the Windows sound driver.

The TS-890S virtual COM port has 2 types: the virtual COM (Standard) port and the virtual COM (Enhanced) port.

The COM port numbers of the virtual COM (Standard) port and virtual COM (Enhanced) port on a PC can be confirmed in the following way:

- Start the Windows Device Manager.
- The following two COM ports appear in “Ports (COM & LPT)” of the Device Manager when the TS-890S is connected through USB cable.  
“Silicon Labs CP210x USB to UART Bridge (COM x)”  
“Silicon Labs CP210x USB to UART Bridge (COM y)”

Numbers are entered in the x and y parts. Numbers vary depending on the environment of a PC used. The following image shows an example where the virtual COM ports of the transceiver are assigned to COM3 and COM4.



- Double-click these in the Device Manager to display each property window.
- Select the “Details” tab and then select the “Location paths” in the pulldown menu of property.
- Move the mouse cursor to the top row in the “Value” area and confirm the number in the parenthesis which is the right-most part of the text.

A row which displays (1) is the virtual COM (Standard) port of the transceiver.

A row which displays (2) is the virtual COM (Enhanced) port of the transceiver.

---

**Note:**

- ◆ To use the ARCP-890 or ARHP-890 through a USB connection, or to use other application software which control the TS-890S through the RS-232C, use the virtual COM (Standard) port.
-

The following are the display examples of the property windows of each COM when the virtual COM (Standard) port is assigned to COM3 and the virtual COM (Enhanced) is assigned to COM4.

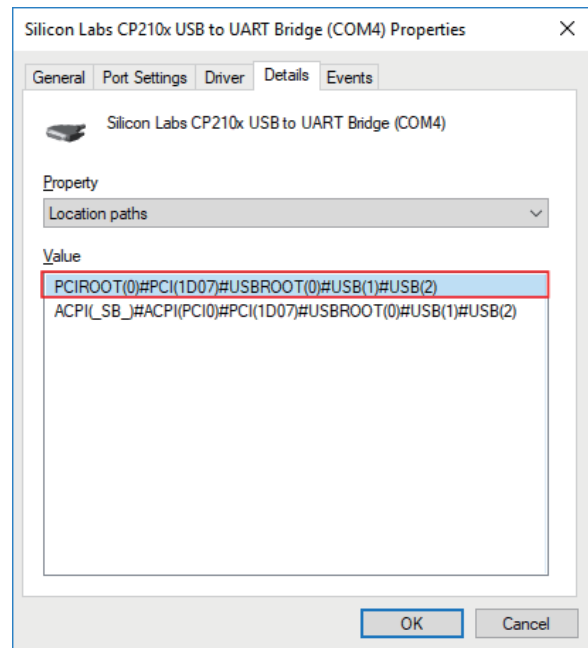
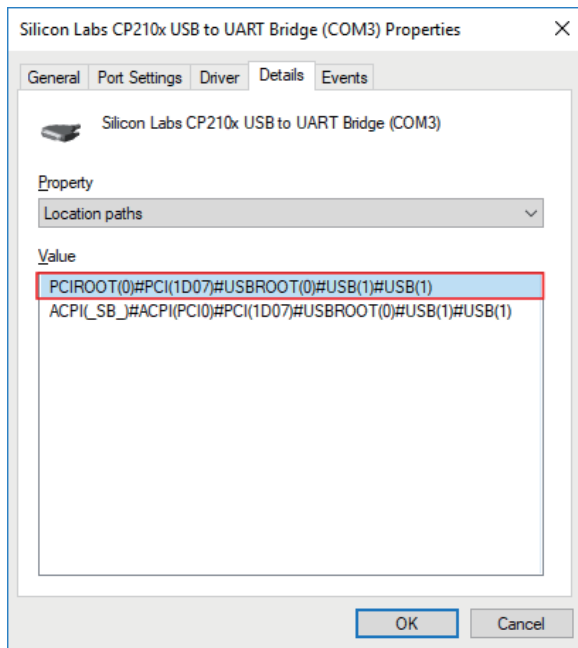

A COM port number will change upon switching a USB port to another USB port of a PC that is connected to the TS-890S by using a USB cable. In this case, confirm again a current COM port number with the above procedure.

## ● Copyrights

- Microsoft®, Windows®, and the Windows logo are the registered trademarks of Microsoft Corporation in the United States and other countries.
- Other company names and product names, etc. are trademarks or registered trademarks of their respective manufacturers.
- Notations about registered trademarks or trademarks are omitted in the body text.

# 10 TERMINAL FUNCTIONS

## ACC 2 Connector

This is an accessory terminal for connecting the TS-890S with an external device.

This terminal is equipped with the following interfaces.

- RX audio output (output level can be configured in the menu)
- Squelch control output
- TX audio input (input level can be configured in the menu)
- PTT (SS) input (Transmits microphone audio input. This is a convenient feature when using devices such as a footswitch.)
- PKS input (Transmits audio input from an external device. Transmission with the microphone input muted is possible. This is a convenient feature for data communication.)
- RTTY keying input
- External meter output (output target can be selected from the menu. Supports dual output.)

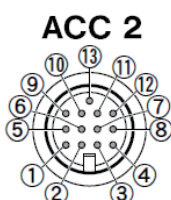

Fig. 76 ACC 2 Connector

Table 8 ACC 2 Connector Pin Assignment

Terminal	ACC 2	
Connector	13pin DIN	
Pin No.	Signal	Use
1	NC	Not used
2	RTTY	Key for RTTY
3	ANO	RX audio
4	GND	GND
5	PSQ (Open:"L")	Squelch
6	MET1	Meter
7	NC	Not used
8	GND	GND
9	PKS	Standby (ACC 2)
10	MET2	Meter
11	ANI	TX audio
12	GND	GND
13	SS	Standby (MIC)



## DISPLAY (DVI-I) Connector

This connector is used for connection with an external monitor. It supports both digital signal and analog signal outputs. The DISPLAY connector employs a DVI-I connector which is able to deliver high image quality when used together with a DVI digital cable. Analog images can also be viewed on a D-SUB 15-pin analog RGB display monitor with the use of a conversion connector and a special cable for the D-SUB 15-pin connector. Needless to say, it also supports the use of DVI analog cables.



Fig. 77 DVI (Male) - VGA (Female) Conversion Connector (Example)

## EXT SP 8 Ω (External Speaker Jack)

This jack is used for connection with an external speaker. The built-in speaker will be muted when an external speaker is connected.

## KEY PAD

Using the KEY PAD jack allows the number of PF keys to be increased.

Connecting user-made PF keys to the KEY PAD jack enables a maximum of eight PF functions to be assigned to them. For example, assigning the channel number of a message memory to a [PF] key enables content of the message memory to be transmitted at a single touch, and this is an effective method such as when speedy operation is required during a contest.

To make your own PF keypad, refer to the following circuit diagram.

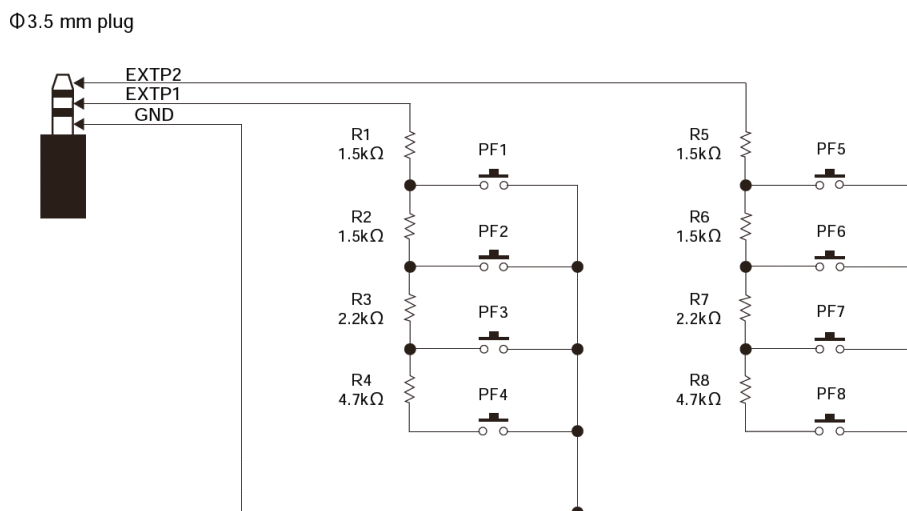

Fig. 78 KEYPAD Circuit Example

## LAN Connector

This connector is used for connection to a PC or LAN when operating using the KNS (KENWOOD NETWORK COMMAND SYSTEM) or to enable automatic time correction using the NTP (Network Time Protocol) server.

It supports the 100BASE-TX and 10BASE-T LAN interface.

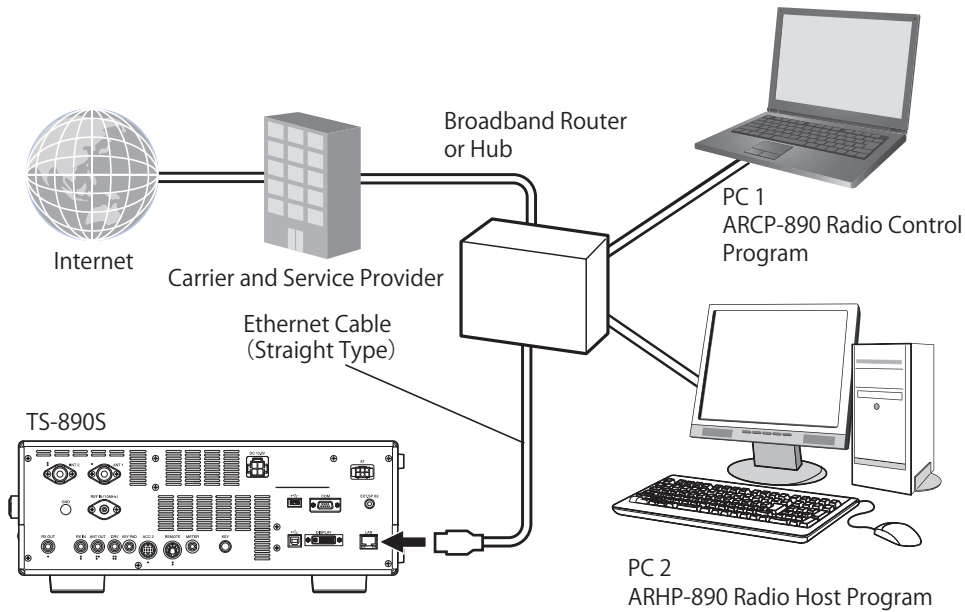

Fig. 79 Example of LAN Connection

During KNS operation using the LAN connector, the current consumption value when power is OFF will vary according to the settings based on the KNS operation style (whether it is remote operation within a LAN or over the Internet).

Table 9 Current when Power is OFF

PC connection by USB	KNS operation setting		
	Off	On (LAN) LAN MODE	On (Internet) WAN MODE
None	Approx. 4 mA	Approx. 35 mA	Approx. 165 mA
Yes	Approx. 105 mA	Approx. 135 mA	Approx. 235 mA

## METER Jack

Connecting an analog meter to the METER jack on the rear panel enables the level of the transmitting and receiving signals to be displayed. Signals can be output separately to External Meter 1 and External Meter 2, and the format of the output signal can be configured in the menu.

Also, the level of the signal output from the TS-890S can be configured separately for External Meter 1 and External Meter 2 according to the rating of the meter that is connected to the METER jack.

The METER jack output rating is as follows.

- Voltage: 0 to 5 V (no load)
- Impedance: 4.7 k $\Omega$

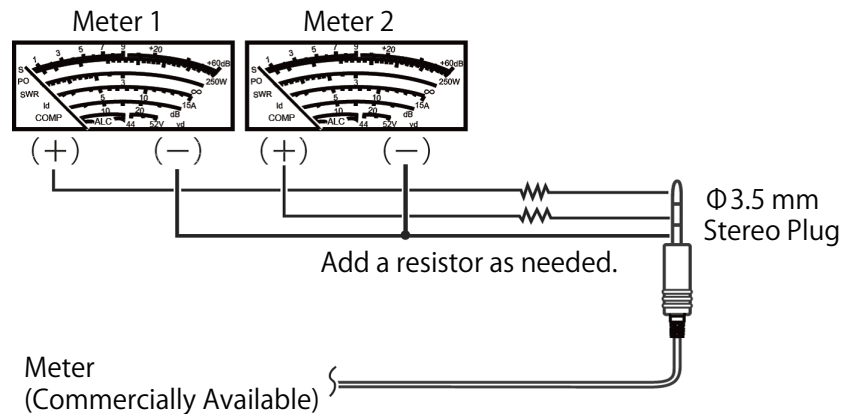

Fig. 80 Example of Meter Circuit

## PADDLE, KEY Jack

The PADDLE jack is placed at the front of the unit for greater ease of use. The TS-890S has an internal electronic keyer which allows you to use a paddle simply by connecting it to the PADDLE jack in front. The KEY jack at the back is configured to “Straight Key” by default. It can be used for input of keying signals from an external device or the straight key.

Both the PADDLE jack and KEY jack can be switched in the menu to one of the functions described below:

- Straight Key (default setting for KEY jack)
- Paddle (default setting for PADDLE jack)
- Bugkey Mode

## PHONES Jack

An internal headphone-dedicated amplifier is available to provide stable output.

It supports the use of monaural and stereo headphones (4 to 32  $\Omega$ , standard: 8  $\Omega$  / plug:  $\phi$ 6.3 mm). However, the audio output will be monaural even when a stereo headphone is connected.

Also, audio output from the built-in speaker (or an optional external speaker) will be muted when a headphone is connected.

### USB Connector (USB-A)

This connector is used for connection to a commercially available USB flash drive or USB keyboard.

There is one USB connector each in front and at the back, which can be used in the same way. It will be convenient to use the front connector for a USB flash drive and the rear connector for connecting a PC keyboard.

#### ● Example of Using a USB Flash Drive

Through the connector, configured settings and voice data created on the TS-890S can be copied to a USB flash drive, and files can also be loaded into the TS-890S. At the same time, it is possible to capture screenshots and save them to the USB flash drive.

Timer recording is also supported.

#### ● Example of Using a USB Keyboard

The connector can be used for text input during RTTY or PSK operation or for editing the text string of memory channel names and file names.

The function keys on the connected PC keyboard can be used to call up a voice message memory or CW/RTTY/PSK message memory.

## USB Connector (USB-B)

This connector is used for connecting a PC. It supports the use of the ARCP-890 for remote control of the TS-890S as well as input and output of TX and RX audio to and from the PC using the USB Audio feature. It can also be used for updating the firmware (firmware update can also be performed using a USB flash drive).

A USB cable conforming to USB2.0 (A connector to B connector type) must be used.

Two USB keying features have also been added on the TS-890S. (For more details, refer to “USB Keying Feature”.)

The internal configuration within the USB-B connector of the TS-890S is shown below.

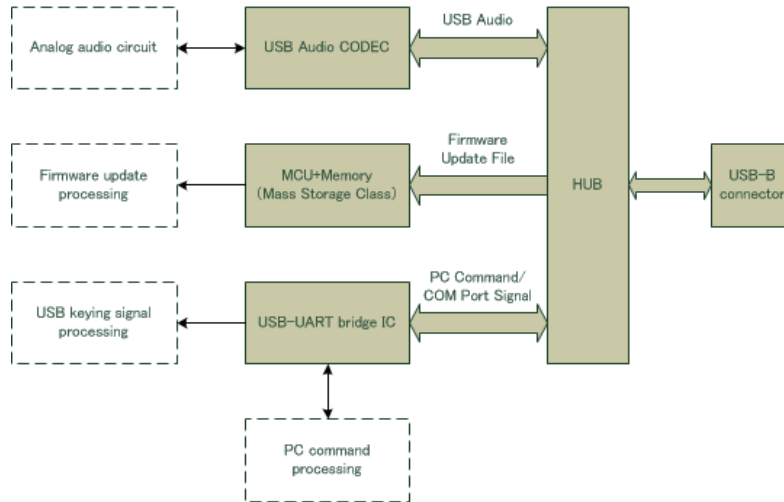

Fig. 81 Block Diagram of USB Connector (Rear Panel) Peripherals

# 11 MECHANICAL STRUCTURE

## Internal Structure

This chapter describes the internal structure of the TS-890S as well as the board (UNIT) layout.

The TS-890S comes with a DC/DC unit at the top left of the chassis and the final unit at the top right. The lower layer is further divided into two layers, with the DSP unit and control unit located at the bottom left and the PLL unit and TR/RX unit at the bottom right. The front panel frame accommodates the display unit.

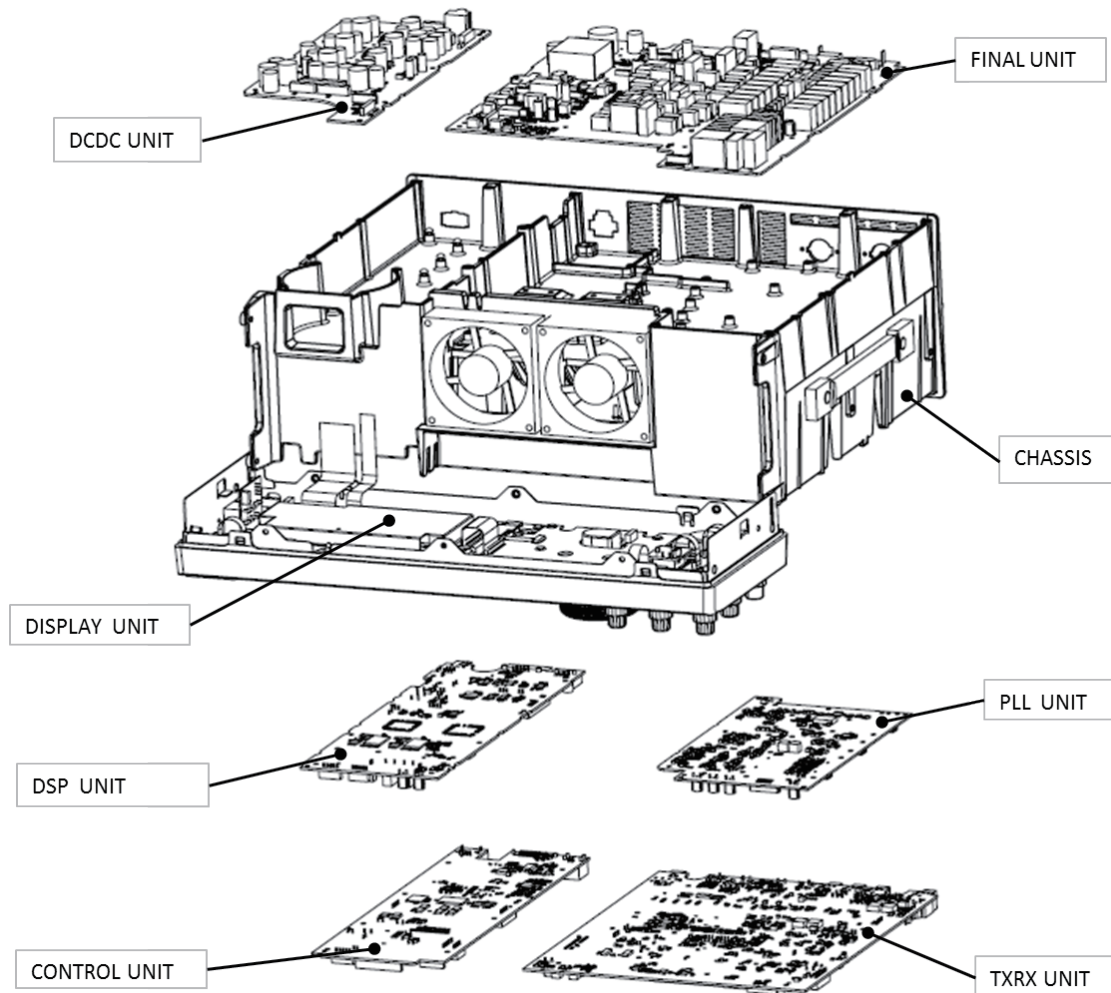

Fig. 82 Structure of Main Unit

In order to mount the boards, the interior of the chassis is partitioned in a lunch-box-like layout with the boards secured in each of the partitions. The lunch-box structure serves to create a shielding effect using the walls of the partitions. Aluminum die-cast (ADC12) is used to make the chassis so as to achieve a shielding and cooling effect.

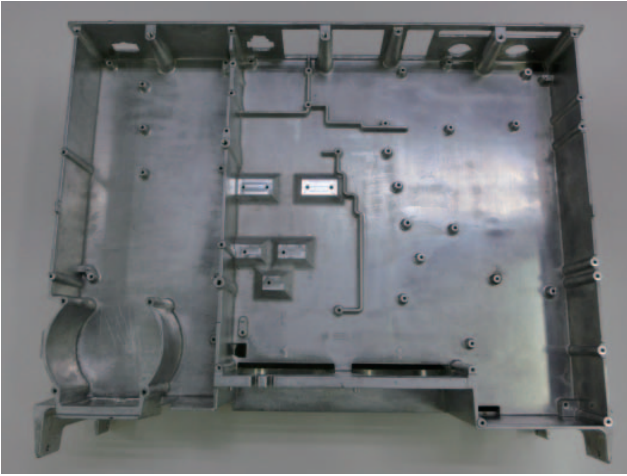

Fig. 83 Chassis (Upper Surface)

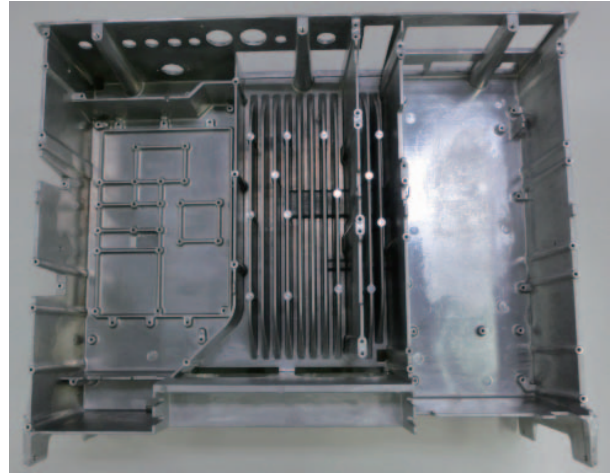

Fig. 84 Chassis (Bottom Surface)

## Cooling

The cooling mechanism is such that heat emitted from the final unit of the TS-890S is directed conveyed to the chassis underneath, which is then discharged from the back of the cooling fan motor using the fin that is located on the reverse side of the final unit.

The TS-890S comes with two internal cooling fan motors (80 mm x 80 mm, thickness: 25 mm).

The two cooling fan motors which are installed in front of the final unit and the fin of the chassis not only helps to cool down the radiating fin, but also prevents the temperature of the parts from rising.

The fan motors can be configured to one of the three operation modes. After countless adjustments of the settings to minimize the noise during their operation, operation noise of the fan motor has been reduced by at least 5 dB (A) compared to the TS-990S.

Even if the temperature rises to an unexpected level, a protection function that reduces the transmit power will be activated to ensure protection against malfunction. The two cooling fan motors are made by Sanyo Denki Co., Ltd., which is a manufacturer of highly-reliable products.



Fig. 85 Fan Placement and Ventilation Flow

The image “Fan Placement and Ventilation Flow” shows a visualized air flow in the chassis on its upper side.

## 11 MECHANICAL STRUCTURE

To let users gain an understanding of the excellent cooling performance of the TS-890S, we will introduce below the temperature increase data of a continuous transmission test that was conducted at 100 W under a temperature of 30°C.

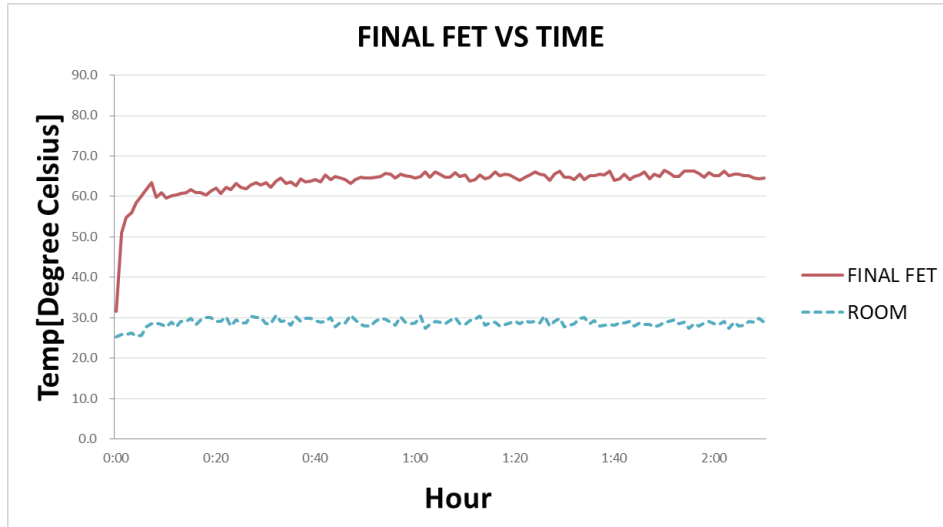

Fig. 86 Continuous Transmission test

From the graph above, when transmission continues for 2 hours or longer at an output power of 100 W under a temperature of 30°C, the TS-890S continues to function properly when the temperature of the FET on the final unit was about 65°C. From this, we can tell that there is no power down (activation of protection) due to insufficient cooling.

Although the TS-890S adopts a heavy-duty design, the life of electronic parts in general (not just KENWOOD products) tends to shorten when the temperature is higher.

To enable long-term use of the TS-890S, it is recommended that it be used at an appropriate output according to the situation.



## Lift-up Mechanism of the Front Bases

For the lift-up mechanism of the front bases, rotary levers are used to allow the extensions to be easily folded and unfolded.

When the extensions are folded, they are invisible from the front without detracting from the esthetic design of the front bases. When the body is lifted up with the extensions, the shapes of the front bases and extensions match in the form of an arc with a look of a unified and beautiful appearance.

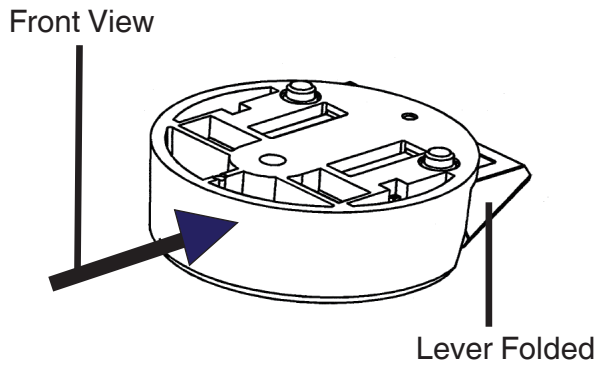

Fig. 87 Lever Closed

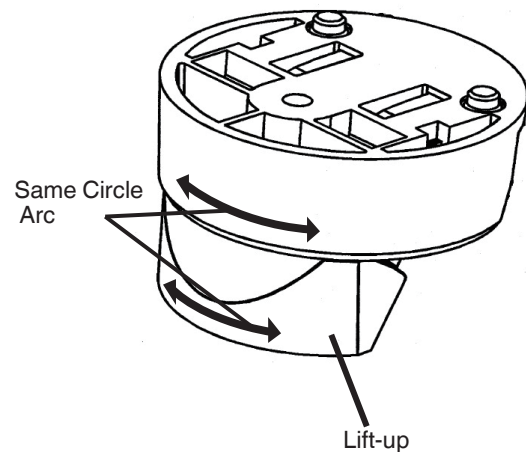

Fig. 88 Lever Open

The lift-up mechanism is designed so that the bottom surface of the front base is aligned with the bottom surface of the extension when it is unfolded, to allow the body to receive its weight at almost a right angle to the direction of gravity. Consequently, the front base can support the heavy weight of the TS-890S with sufficient allowance and without adding stress to the rotary arm.

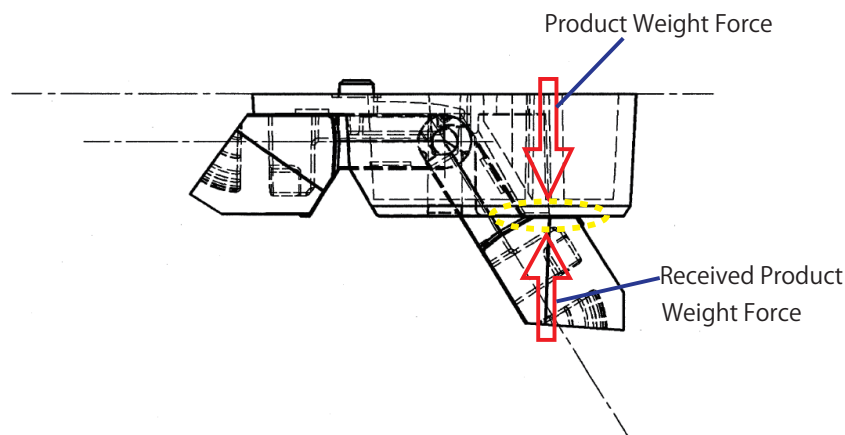

Fig. 89 Direction of the Weight Load when the TS-990S is Lifted

## Operability

The keys and rotary knobs, which have a direct bearing on the operability, adopt a layout that allows their direct access and are designed for intuitive operation.

The TS-890S has 72 keys and 13 rotary knobs of various sizes, adjusted to internal and external shafts diameters. The TS-990S, which is the higher-end model, has 110 keys and a total of 28 rotary knobs of various sizes, adjusted to internal and external shafts diameters.

Although there are less keys on the TS-890S compared to the TS-990S due to the difference in the size of the transceiver set, the TS-890S adopts a greater variety of key shapes (15 types) than the TS-990S (12 types). Having a wider variety of shapes allows for more intuitive operation.

Meanwhile, the TS-890S inherits the well-received design of the rotary knobs on the TS-990S, which are optimally placed apart from one another for enhanced operability.



Fig. 90 TS-890S and TS-990S

When determining the design layout of the TS-890S, the market evaluation and issues of the TS-990S have been taken into consideration. At the same time, to ensure the optimal layout of the keys and rotary knobs, a 3D printout of the key and rotary knob layout was created before mock-ups (dummy models with the actual dimensions) were manufactured to review the size, shape, position and spacing of the individual parts.

The well-received layout of the TS-990S, which allows direct access to the keys and rotary knobs, is also adopted on the TS-890S. By actually trying out the TS-890S, you will be able to have a direct feel of the positioning of the keys and rotary knobs, which are divided into separate functional blocks. Yet another design concept that the TS-890S takes after the TS-990S is the assignment of a single function to a key or rotary knob with little complexity in the structure and a minimal number of keys or rotary knobs with multiple functions.



Fig. 91 Key and Rotary Knob Allocation

The TS-890S adopts the same structure as the premium TS-990S with primary emphasis on the texture to optimize the operability of the keys. Resin keys that are coated or plated are also used to create a premium feel.

Adopting the same key structure as the TS-990S helps to eliminate unevenness on key touches and provide a uniform and excellent texture regardless of the angle from which the key is pressed.

Additionally, for the key indicators, the structure of the TS-990S has been adopted to provide them with high illumination intensity and less unevenness.

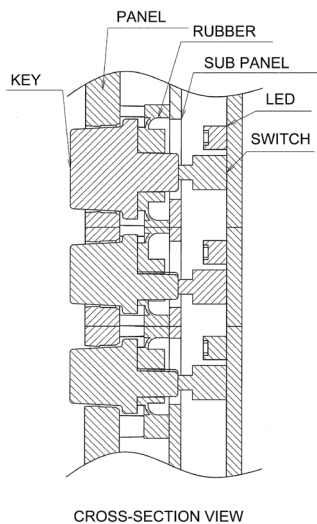

Fig. 92 Key Structure

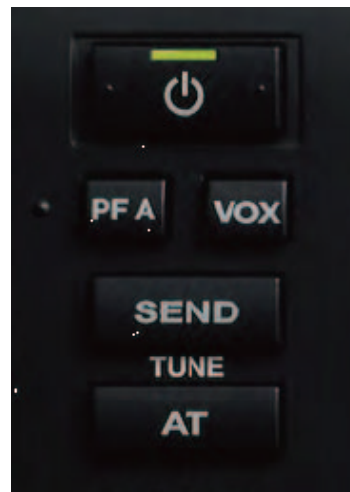

Fig. 93 POWER Key Illumination

## TFT Display and Touch Panel

The TFT display of the TS-890S employs a 7-inch TFT LCD with an LED backlight which takes into consideration the operating environment, image quality and life-span. The TFT display is long-life and free from optical irregularities, and provides beautiful imaging.

The brightness of the TFT LCD and indicators can be adjusted separately. Also, it is possible to fine-tune the color tone of the TFT LCD image. These enable the TS-890S to be configured to the optimal settings according to the environment in which it is used.



Fig. 94 TFT LCD

As with the TS-990S, a touch panel has been employed to add an element of fun to the transceiver functions, such as by allowing the frequency at a point to be set when you touch the point on the bandscope screen.

## Main Control Knob Mechanism

The main control knob is made of aluminum that is NC-machined.

Its shape was designed by taking into account the rotational balance and suppression of eccentricity. The design results in a superb operational feeling of a weighted, smooth, and accurate touch. The surface of the main knob is machined by a specially-designed tool bit and is finished so that it has a radially lucent spin-cut pattern.

The torque adjustment ring, which is placed on the main knob shaft, is made of aluminum die-cast. Uncompromising attention was also given to the texture of the main knob.

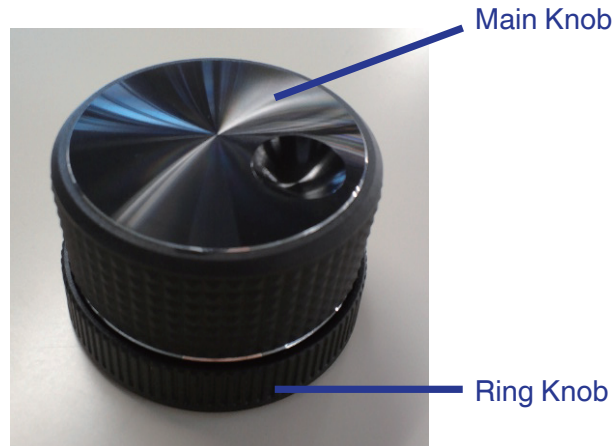

Fig. 95 Appearance of the Main Knob

The rotation mechanism of the torque adjustment ring employs a coated metal plate in its slider block, which secures better clicks, smoother rotation, and longer durability.

Furthermore, its friction material is carefully chosen for better torque adjustment. An aluminum sheet is used for the surface of the arm on the main knob side and artificial leather is used for the friction material on the opposite side to reduce rotation noise and ensure smooth rotation.

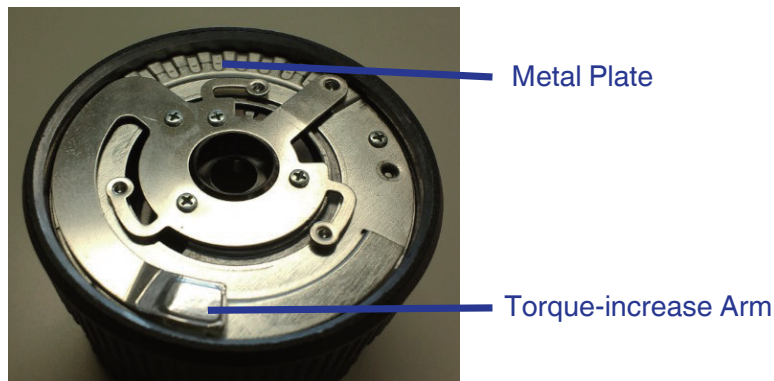

Fig. 96 Inside the Torque Adjustment Ring

## 12 SP-890

---

This premium external speaker for communications enables system enhancement when it is used with the TS-890S.

### Appearance and Features

The front panel is aluminum die-casting and the speaker net is a punched metal sheet intended for better sound transit to secure good sound quality by its fundamental structure.

The SP-890 has a simple design but high affinity to the TS-890S.



Fig. 97 Appearance of the SP-890

Achieving clear tones without incidental noise, or in other words, sound quality without peculiar characteristics, the SP-890 allows users to freely create their own sound.

### Speaker

The SP-890 is an 80 mm full range speaker.

Due to its flat frequency characteristics in the audio band, the speaker is chosen to allow the desired sound to be produced through the TS-890S equalizer.

## Built-in Passband Filter

The built-in passband filters, which are also popular on the SP-990, are designed with optimized values for the full-range speaker. High-cut and low-cut filters are installed, and the optimal filters can be selected according to the mode, such as SSB or CW operation. Doing so allows frequency characteristics suited for a wide range of uses to be obtained.

The charts below show the frequency characteristics.



Fig. 98 Filter Switch (Front Panel)

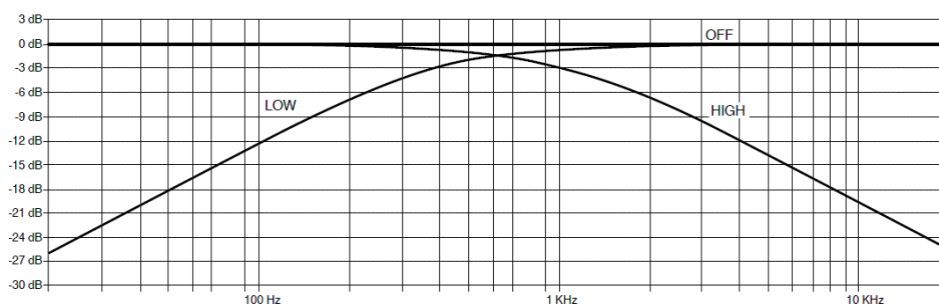

Fig. 99 Characteristics of High-Cut Filters and Low-Cut Filters

## Speaker Input Select Switch

The speaker has two speaker input terminals, A and B. When two transceivers are connected to the speaker, the sound source can be toggled on the front panel. This also applies to connecting a set of headphones.



Fig. 100 Input Select (A/B) Switch (Front Panel)

TS-890S In-depth Manual  
May 17, 2019  
CA-337W-E96  
Copyright © 2019 JVCKENWOOD Corporation  
All Rights Reserved.